



# 0 to 1000 kPa (0 to 150 PSI) On-Chip Signal Conditioned, 0.2 V to 4.7 V Output, Temperature Compensated and Calibrated, Silicon Pressure Sensor

The MPX5999D piezoresistive transducer is a state-of-the-art pressure sensor designed for a wide range of applications, but particularly for those employing a microcontroller or microprocessor with A/D inputs. This patented, single element X-ducer combines advanced micromachining techniques, thin-film metallization and bipolar semiconductor processing to provide an accurate, high level analog output signal that is proportional to applied pressure.

Figure 1 shows a block diagram of the internal circuitry integrated on the stand-alone sensing chip.

### Features

- Temperature Compensated Over 0 to 85°C
- Ideally Suited for Microprocessor or Microcontroller-Based Systems
- Patented Silicon Shear Stress Strain Gauge
- Durable Epoxy Unibody Element

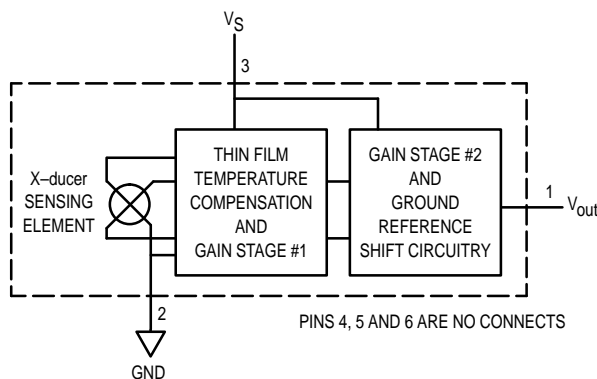

Figure 1. Fully Integrated Pressure Sensor Schematic

### MAXIMUM RATINGS(1)

Parametrics	Symbol	Value	Unit
Overpressure <sup>(2)</sup> (P1 > P2)	P <sub>max</sub>	4000	kPa
Burst Pressure <sup>(2)</sup> (P1 > P2)	P <sub>burst</sub>	6000	kPa
Storage Temperature	T <sub>stg</sub>	-40° to +150	°C
Operating Temperature	T <sub>A</sub>	-40° to +125	°C

1. T<sub>C</sub> = 25°C unless otherwise noted. Maximum Ratings apply to Case 867-08 only.
2. Extended exposure at the specified limits may cause permanent damage or degradation to the device.
3. This sensor is designed for applications where P1 is always greater than, or equal to P2.

Senseon and X-ducer are trademarks of Motorola, Inc.

(Replaces MPX5999)

**MPX5999D**

X-ducer™  
SILICON  
PRESSURE SENSORS

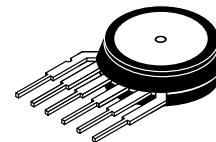

**BASIC CHIP  
CARRIER ELEMENT  
CASE 867-08, STYLE 1**

### PIN NUMBER

1	V <sub>out</sub>	4	N/C
2	Gnd	5	N/C
3	V <sub>S</sub>	6	N/C

NOTE: Pins 4, 5, and 6 are internal device connections. Do not connect to external circuitry or ground. Pin 1 is noted by the notch in the Lead.

## MPX5999D

### OPERATING CHARACTERISTICS ( $V_S = 5.0$ Vdc, $T_A = 25^\circ\text{C}$ unless otherwise noted, $P_1 > P_2$ )

Characteristic	Symbol	Min	Typ	Max	Unit
Pressure Range <sup>(1)</sup>	$P_{OP}$	0	—	1000	kPa
Supply Voltage <sup>(2)</sup>	$V_S$	4.75	5.0	5.25	Vdc
Supply Current	$I_o$	—	7.0	10	mAdc
Zero Pressure Offset <sup>(3)</sup> (0 to 85°C)	$V_{off}$	0.088	0.2	0.313	Vdc
Full Scale Output <sup>(4)</sup> (0 to 85°C)	$V_{FSO}$	4.587	4.7	4.813	Vdc
Full Scale Span <sup>(5)</sup> (0 to 85°C)	$V_{FSS}$	—	4.5	—	Vdc
Sensitivity	$V/P$	—	4.5	—	mV/kPa
Accuracy <sup>(6)</sup> (0 to 85°C)	—	—	—	±2.5	% $V_{FSS}$
Response Time <sup>(7)</sup>	$t_R$	—	1.0	—	ms
Output Source Current at Full Scale Output	$I_{O+}$	—	0.1	—	mA
Warm-Up <sup>(8)</sup>	—	—	20	—	Sec

### MECHANICAL CHARACTERISTICS

Characteristic	Symbol	Min	Typ	Max	Unit
Weight, Basic Element (Case 867)	—	—	4.0	—	Grams
Cavity Volume	—	—	—	0.01	IN <sup>3</sup>
Volumetric Displacement	—	—	—	0.001	IN <sup>3</sup>

#### NOTES:

- 1.0 kPa (kiloPascal) equals 0.145 psi.
- Device is ratiometric within this specified excitation range.
- Offset ( $V_{off}$ ) is defined as the output voltage at the minimum rated pressure.
- Full Scale Output ( $V_{FSO}$ ) is defined as the output voltage at the maximum or full rated pressure.
- Full Scale Span ( $V_{FSS}$ ) is defined as the algebraic difference between the output voltage at full rated pressure and the output voltage at the minimum rated pressure.
- Accuracy (error budget) consists of the following:
  - Linearity: Output deviation from a straight line relationship with pressure over the specified pressure range.
  - Temperature Hysteresis: Output deviation at any temperature within the operating temperature range, after the temperature is cycled to and from the minimum or maximum operating temperature points, with zero differential pressure applied.
  - Pressure Hysteresis: Output deviation at any pressure within the specified range, when this pressure is cycled to and from the minimum or maximum rated pressure, at 25°C.
  - TcSpan: Output deviation over the temperature range of 0° to 85°C, relative to 25°C.
  - TcOffset: Output deviation with minimum rated pressure applied, over the temperature range of 0° to 85°C, relative to 25°C.
  - Variation from Nominal: The variation from nominal values, for Offset or Full Scale Span, as a percent of  $V_{FSS}$ , at 25°C.
- Response Time is defined as the time for the incremental change in the output to go from 10% to 90% of its final value when subjected to a specified step change in pressure.
- Warm-up is defined as the time required for the device to meet the specified output voltage after the pressure has been stabilized.
- P2 max is 500 kPa.

ON-CHIP TEMPERATURE COMPENSATION, CALIBRATION AND SIGNAL CONDITIONING

Figure 2 shows the sensor output signal relative to pressure input. Typical, minimum and maximum output curves are shown for operation over 0°C to 85°C. (Device output may be nonlinear outside of the rated pressure range.)

The performance over temperature is achieved by integrating the shear-stress strain gauge, temperature compensation, calibration and signal conditioning circuitry onto a single monolithic chip.

Figure 3 illustrates the differential or gauge configuration in the basic chip carrier (Case 867). A fluoro silicone gel isolates the die surface and wire bonds from harsh environments,

while allowing the pressure signal to be transmitted to the silicon diaphragm.

The MPX5999D pressure sensor operating characteristics, and internal reliability and qualification tests are based on use of dry air as the pressure media. Media other than dry air may have adverse effects on sensor performance and long-term reliability. Contact the factory for information regarding media compatibility in your application.

Figure 4 shows a typical decoupling circuit for interfacing the output of the MPX5999D to the A/D microprocessor. Proper decoupling of the power supply is recommended.

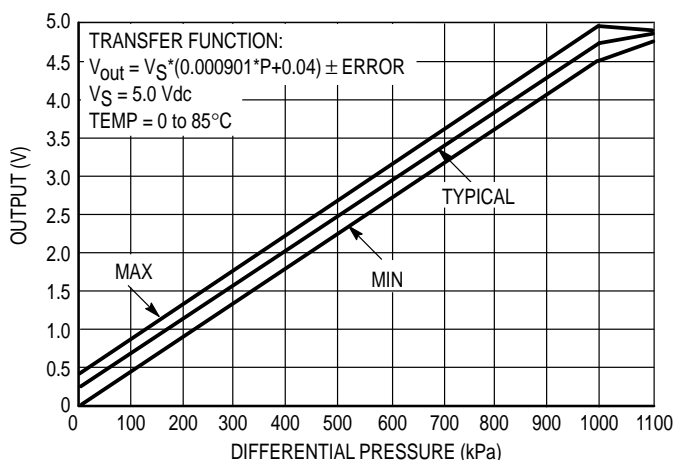

Figure 2. Output versus Pressure Differential

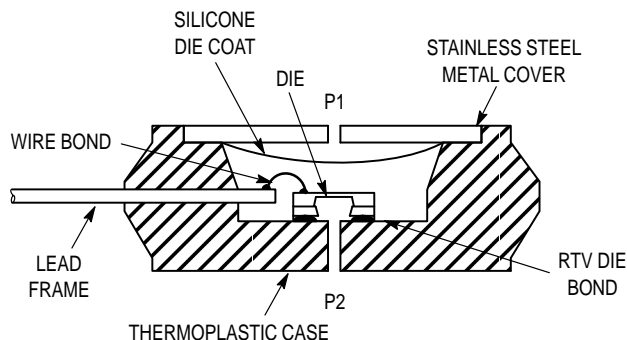

Figure 3. Cross-Sectional Diagram (Not to Scale)

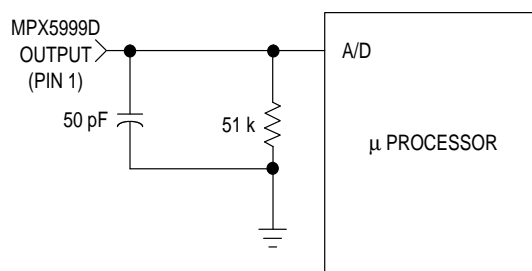

Figure 4. Typical Decoupling Filter for Sensor to Microprocessor Interface

## MPX5999D

### PRESSURE (P1) / VACUUM (P2) SIDE IDENTIFICATION TABLE

Motorola designates the two sides of the pressure sensor as the Pressure (P1) side and the Vacuum (P2) side. The Pressure (P1) side is the side containing fluoro silicone gel which protects the die from harsh media. The Motorola MPX

pressure sensor is designed to operate with positive differential pressure applied,  $P1 > P2$ .

The Pressure (P1) side may be identified by using the table below:

Part Number	Case Type	Pressure (P1) Side Identifier
MPX5999D	867-08	Stainless Steel Cap

### ORDERING INFORMATION

The MPX5999D pressure sensor is available as an element only.

Device Type	Options	Case Type	MPX Series	
			Order Number	Device Marking
Basic Element	Differential	867-08	MPX5999D	MPX5999D

PACKAGE DIMENSIONS

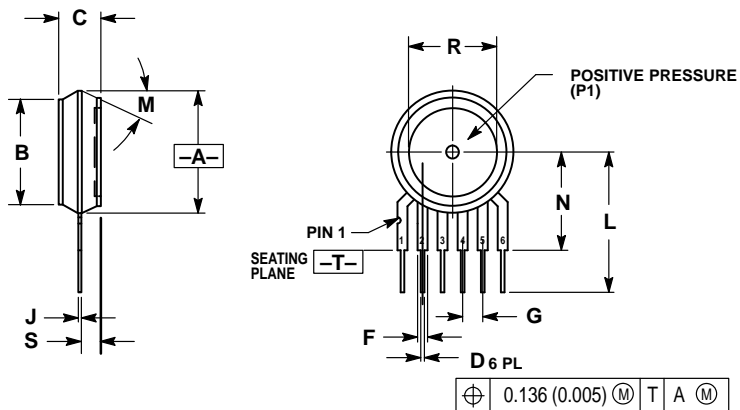

- NOTES:
1. DIMENSIONING AND TOLERANCING PER ANSI Y14.5M, 1982.
  2. CONTROLLING DIMENSION: INCH.
  3. DIMENSION -A- IS INCLUSIVE OF THE MOLD STOP RING. MOLD STOP RING NOT TO EXCEED 16.00 (0.630).

DIM	INCHES		MILLIMETERS	
	MIN	MAX	MIN	MAX
A	0.595	0.630	15.11	16.00
B	0.514	0.534	13.06	13.56
C	0.200	0.220	5.08	5.59
D	0.027	0.033	0.68	0.84
F	0.048	0.064	1.22	1.63
G	0.100 BSC		2.54 BSC	
J	0.014	0.016	0.36	0.40
L	0.695	0.725	17.65	18.42
M	30°NOM		30°NOM	
N	0.475	0.495	12.07	12.57
R	0.430	0.450	10.92	11.43
S	0.090	0.105	2.29	2.66

- STYLE 1:  
 PIN 1. VOUT  
 2. GROUND  
 3. VCC  
 4. V1  
 5. V2  
 6. VEX

CASE 867-08  
 ISSUE N

BASIC ELEMENT (A, D)

Motorola reserves the right to make changes without further notice to any products herein. Motorola makes no warranty, representation or guarantee regarding the suitability of its products for any particular purpose, nor does Motorola assume any liability arising out of the application or use of any product or circuit, and specifically disclaims any and all liability, including without limitation consequential or incidental damages. "Typical" parameters which may be provided in Motorola data sheets and/or specifications can and do vary in different applications and actual performance may vary over time. All operating parameters, including "Typicals" must be validated for each customer application by customer's technical experts. Motorola does not convey any license under its patent rights nor the rights of others. Motorola products are not designed, intended, or authorized for use as components in systems intended for surgical implant into the body, or other applications intended to support or sustain life, or for any other application in which the failure of the Motorola product could create a situation where personal injury or death may occur. Should Buyer purchase or use Motorola products for any such unintended or unauthorized application, Buyer shall indemnify and hold Motorola and its officers, employees, subsidiaries, affiliates, and distributors harmless against all claims, costs, damages, and expenses, and reasonable attorney fees arising out of, directly or indirectly, any claim of personal injury or death associated with such unintended or unauthorized use, even if such claim alleges that Motorola was negligent regarding the design or manufacture of the part. Motorola and  are registered trademarks of Motorola, Inc. Motorola, Inc. is an Equal Opportunity/Affirmative Action Employer.

Mfax is a trademark of Motorola, Inc.

**How to reach us:**

**USA/EUROPE/Locations Not Listed:** Motorola Literature Distribution;  
P.O. Box 5405, Denver, Colorado 80217. 303-675-2140 or 1-800-441-2447

**JAPAN:** Nippon Motorola Ltd.; Tatsumi-SPD-JLDC, 6F Seibu-Butsuryu-Center,  
3-14-2 Tatsumi Koto-Ku, Tokyo 135, Japan. 81-3-3521-8315

**Mfax™:** RMFAX0@email.sps.mot.com – TOUCHTONE 602-244-6609  
– US & Canada ONLY 1-800-774-1848

**ASIA/PACIFIC:** Motorola Semiconductors H.K. Ltd.; 8B Tai Ping Industrial Park,  
51 Ting Kok Road, Tai Po, N.T., Hong Kong. 852-26629298

**INTERNET:** <http://motorola.com/sps>

