

GENERAL DESCRIPTION

The CM2843 family is positive, linear regulators featured low quiescent current (30µA typ.) with low dropout voltage, making them ideal for battery applications. The space-saving SOT-23-5 package is attractive for "Pocket" and "Hard Held" applications.

These rugged devices have both Thermal Shutdown, and Current Fold-back to prevent device failure under the "Worst" of operating conditions.

An additional feature is a "Power Good" detector, which pulls low when the output is out of regulation.

The CM2843 is stable with an output capacitance of 2.2µF or greater.

FEATURES

- ◆ Very Low Dropout Voltage
- ◆ Low Current Consumption: Typ. 30µA, Max. 35µA
- ◆ High Accuracy Output Voltage: +/- 2.5%
- ◆ Guaranteed 300mA Output
- ◆ Input Range up to 7.0V
- ◆ Thermal Shutdown
- ◆ Current Limiting
- ◆ Power Good Output Function
- ◆ Compact Package: SOT-23-5
- ◆ Factory Pre-set Output Voltages
- ◆ Short Circuit Current Fold-Back
- ◆ Low Temperature Coefficient

APPLICATIONS

- ◆ Battery-powered devices
- ◆ Personal communication devices
- ◆ Home electric/electronic appliances
- ◆ PC peripherals

TYPICAL APPLICATIONS

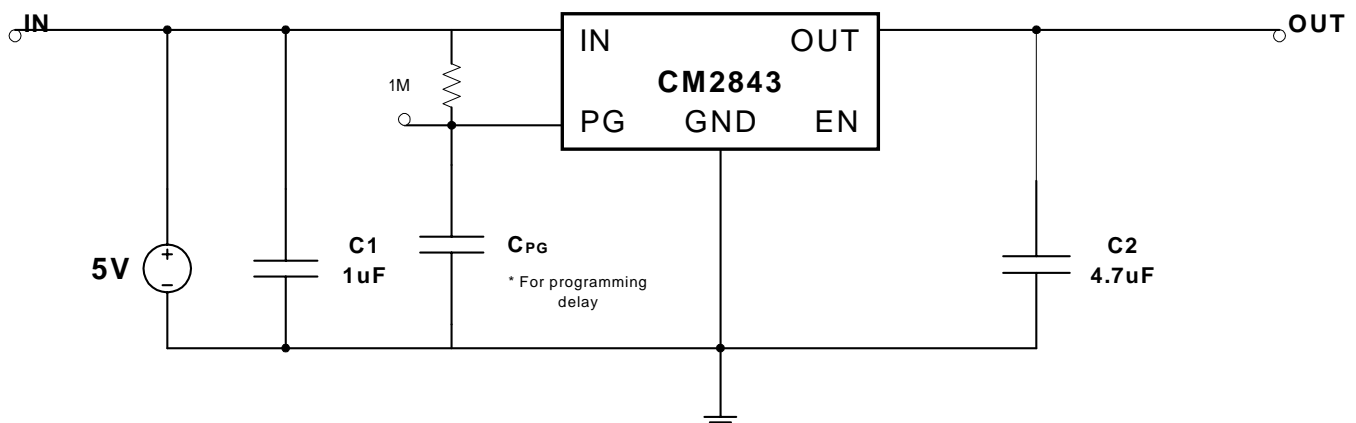

PIN CONFIGURATION

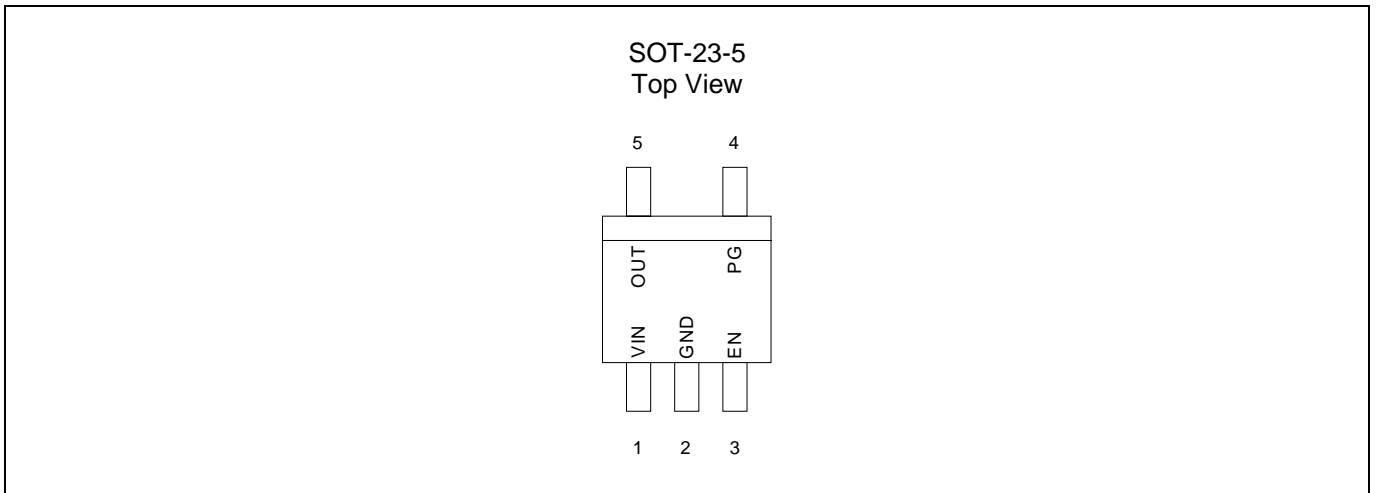

BLOCK DIAGRAM

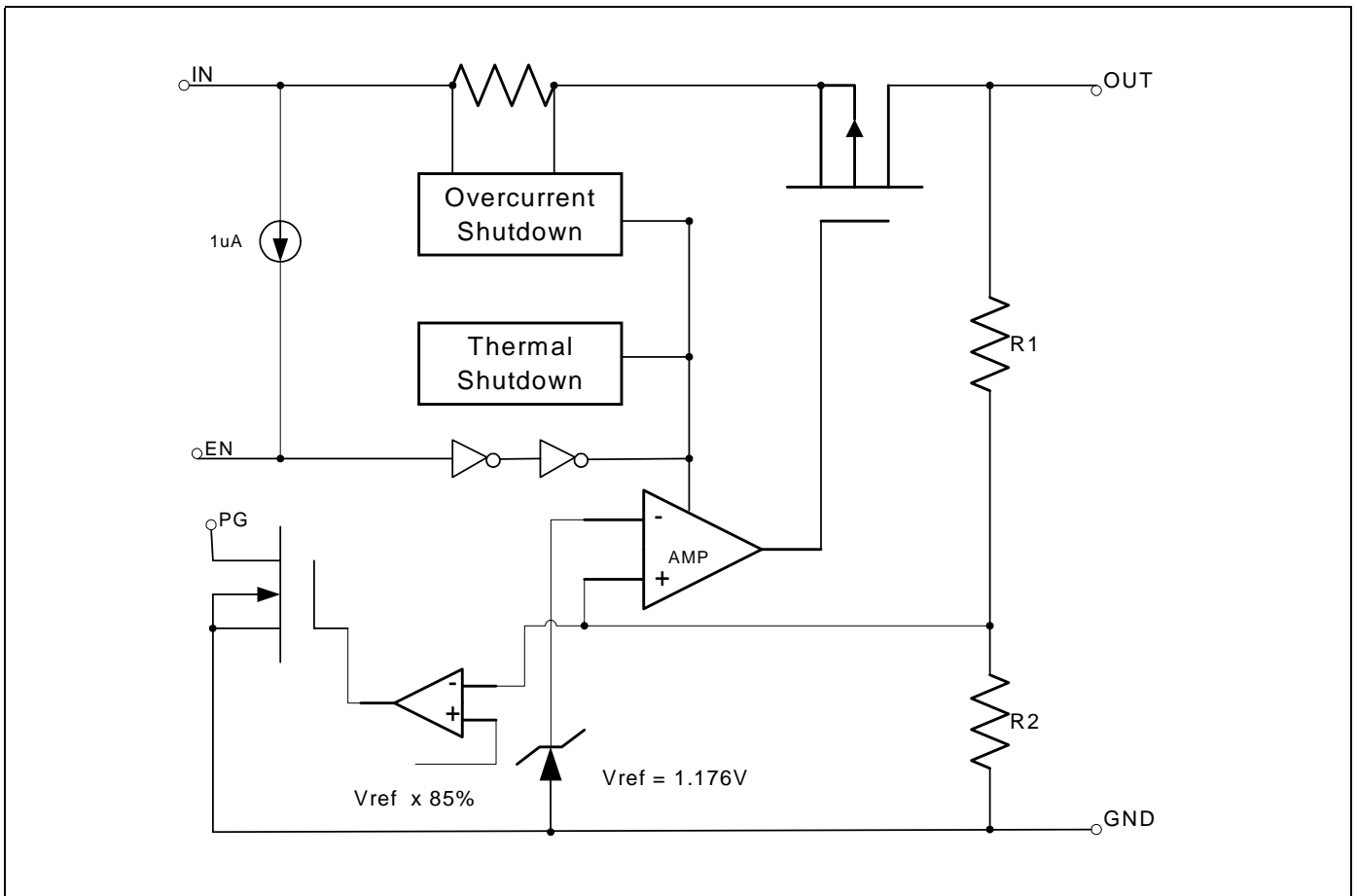

ORDERING INFORMATION

Part Number	Output Voltage	Temperature Range	Package
CM2843ACIM25	1.2V	-40 ~ +85	SOT-23-5
CM2843ABIM25	1.3V	-40 ~ +85	SOT-23-5
CM2843AIM25	1.5V	-40 ~ +85	SOT-23-5
CM2843GACIM25	1.2V	-40 ~ +85	SOT-23-5
CM2843GABIM25	1.3V	-40 ~ +85	SOT-23-5
CM2843GAIM25	1.5V	-40 ~ +85	SOT-23-5

Note: For other pre-set output voltage, please contact Champion Sales office.

ABSOLUTE MAXIMUM RATINGS

Input Voltage +7V
Output Current $P_D / (V_{IN} - V_o)$
Output Voltage GND-0.3V to $V_{IN}+0.3V$
ESD Classification B

OPERATING RATINGS

Ambient Temperature Range (T_A) -40 to +85
Junction Temperature Range -40 to +125

THERMAL INFORMATION

Parameter		Maximum	Unit
Thermal Resistance (θ_{jc})	SOT-23-5	160	/W
Internal Power Dissipation (P_D) ($T = 100^\circ C$)	SOT-23-5	250	mW
Maximum Junction Temperature		150	
Maximum Lead Temperature (10 Sec)		300	

*With Junction sink capable of twice times of θ_{jc}

Caution: Stress above the listed absolute rating may cause permanent damage to the device.

ELECTRICAL CHARACTERISTICS

$T_A = +25^\circ\text{C}$; unless otherwise noted

Parameter	Symbol	Test Conditions	CM2843			Unit	
			Min.	Typ.	Max.		
Input Voltage	V_{IN}		Note 1		7	V	
Output Voltage Accuracy	V_{OUT}	$I_O = 1\text{mA}$	-2.5		2.5	%	
Dropout Voltage	$V_{DROPOUT}$	$I_O = 300\text{mA}$, $V_{OUT} = V_{O(NOM)} - 2\%$	$1.2\text{V} < V_{O(NOM)} \leq 2.0\text{V}$		1300	mV	
			$2.0\text{V} < V_{O(NOM)} \leq 2.5\text{V}$		800		
			$2.5\text{V} < V_{O(NOM)}$		300		
Output Current	I_O	$V_{OUT} > 1.2\text{V}$	300			mA	
Current Limit	I_{LIM}	$V_{OUT} > 1.2\text{V}$	300	450		mA	
Short Circuit Current	I_{SC}	$V_{OUT} < 0.8\text{V}$		150	300	mA	
Quiescent Current	I_Q	$I_O = 0\text{mA}$		30	35	μA	
Ground Pin Current	I_{GND}	$I_O = 1\text{mA}$ to 300mA		30	35	μA	
Line Regulation	REG_{LINE}	$I_{OUT} = 1\text{mA}$, $V_{IN} = V_{OUT} + 1$ to $V_{OUT} + 2$	$V_{OUT} < 2.0\text{V}$	-0.1	0.02	0.1	%
			$2.0\text{V} < V_{OUT} < 3.0\text{V}$	-0.15	0.03	0.15	%
			$3.0\text{V} < V_{OUT}$	-0.3	0.06	0.3	%
Load Regulation	REG_{LOAD}	$I_O = 1\text{mA}$ to 300mA		0.2	1	%	
Over Temperature Shutdown	OTS			150			
Over Temperature Hysteresis	OTH			30			
V_{OUT} Temperature Coefficient	TC			25		ppm/	
Power Supply Rejection	PSRR	$I_O = 100\text{mA}$ $C_O = 2.2\mu\text{F}$ ceramic	$f = 1\text{kHz}$		60	dB	
			$f = 10\text{kHz}$		50		
			$f = 100\text{kHz}$		40		
Output Voltage Noise	eN	$f = 10\text{Hz}$ to 100kHz $I_O = 10\text{mA}$			30	μV_{rms}	
EN Input Bias Current	I_{EH}	$V_{EN} = V_{IN}$, $V_{IN} = 2.7\text{V}$ to 7V			0.1	μA	
	I_{EL}	$V_{EN} = 0\text{V}$, $V_{IN} = 2.7\text{V}$ to 7V		1.0	3.0	μA	
EN Input Threshold	V_{EH}	$V_{IN} = 2.7\text{V}$ to 7V		$V_{IN}/2 + 0.8\text{V}$	V_{IN}	V	
	V_{EL}	$V_{IN} = 2.7\text{V}$ to 7V	0	$V_{IN}/2 - 0.8\text{V}$		V	
Shutdown Supply Current	I_{SD}	$V_{IN} = 5.0\text{V}$, $V_{OUT} = 0\text{V}$, $V_{EN} < V_{EL}$		2.0	3.0	μA	
Shutdown Output Voltage	$V_{O,SD}$	$I_O = 150\text{mA}$	0		0.1	V	
Output Under Voltage	V_{UV}	$2.5\text{V} \leq V_{OUT} \leq 5.0\text{V}$			85	% $V_{O(NOM)}$	
		$1.2\text{V} \leq V_{OUT} \leq 2.5\text{V}$			85		
PG Leakage Current	I_{LC}	$V_{PG} = 7\text{V}$			1	μA	
PG Voltage Rating	V_{PG}	V_{OUT} in regulation			7	V	
PG Voltage Low	V_{OL}	$I_{SINK} = 2\text{mA}$			0.1	V	
Delay Time to PG	t_{DELAY}		1		5	ms	

Note 1. $V_{IN(MIN)} = V_{OUT} + V_{DROPOUT}$

DETAILED DESCRIPTION

The CM2843 family of CMOS regulators contain a PMOS pass transistor, voltage reference, error amplifier, over-current protection, output short circuit protection, thermal shutdown, and power good function.

The P-channel pass transistor receives data from the error amplifier, over-current shutdown, short output protection, and thermal protection circuits. During normal operation, the error amplifier compares the output voltage to a precision reference. Over-current and Thermal shutdown circuits become active when the junction temperature exceeds 150 °C, or the current exceeds 300mA. During thermal shutdown, the output voltage remains low. Normal operation is restored when the junction temperature drops below 120 °C.

The CM2843 switches from voltage mode to current mode when the load exceeds the rated output current. This prevents over-stress. The CM2843 also incorporates current fold-back to reduce power dissipation when the output is short-circuited. This feature becomes active when the output drops below 0.95V, and reduces the current flow by 65%. Full current is restored when the voltage exceeds 0.95V.

EXTERNAL CAPACITOR

The CM2843 is stable with an output capacitor to ground of 2.2µF or greater. It can keep stable even with higher or poor ESR capacitors. A second capacitor is recommended between the input and ground to stabilize VIN. The input capacitor should be larger than 0.1µF to have a beneficial effect. All capacitors should be placed in close proximity to the pins. A “quiet” ground termination is desirable.

ENABLE

The Enable pin normally floats high. When actively, pulled low, the PMOS pass transistor shut off, and all internal circuits are powered down. In this state, the quiescent current is less than 1µA. This pin behaves much like an electronic switch.

POWER GOOD

The CM2843 includes the Power Good feature. Normally, Pin 4 is “Floating”, however, when the output is less than 15% of the specified voltage, it pulls low. This can occur under the following conditions:

- 1) Input Voltage too low
- 2) During Over-Temperature
- 3) During Over-Current

TYPICAL ELECTRICAL CHARACTERISTICS

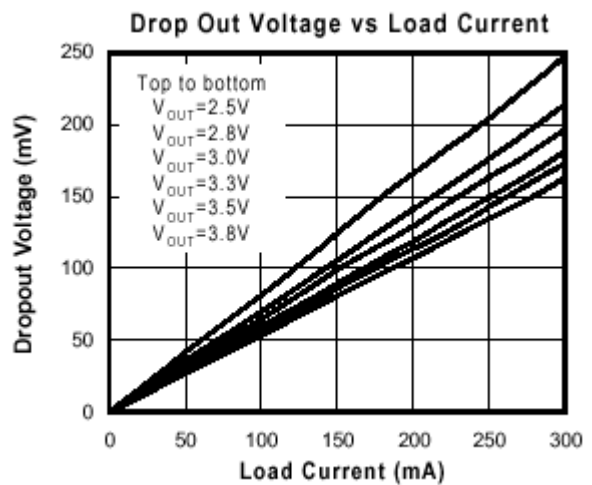
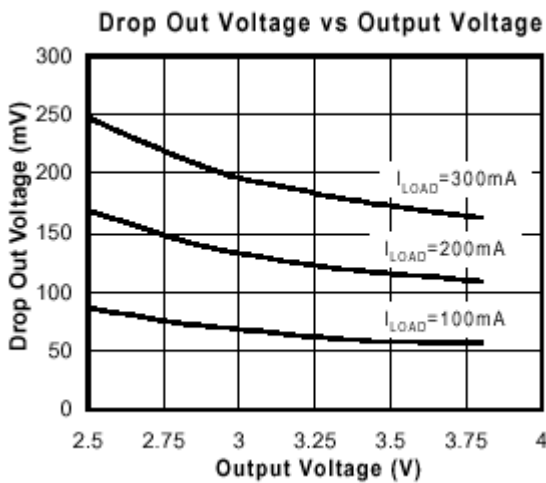
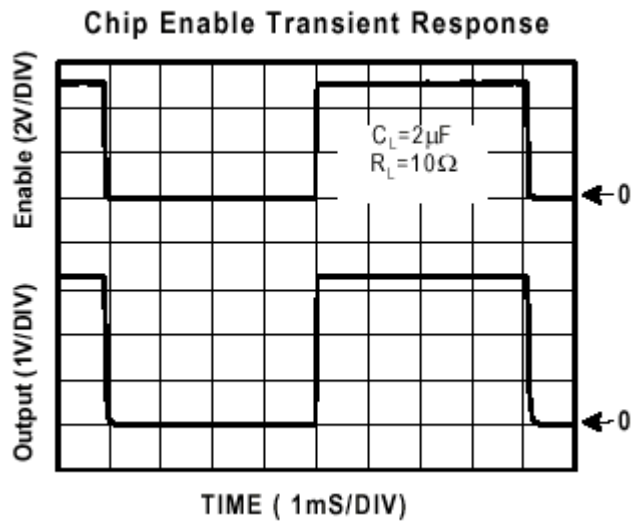
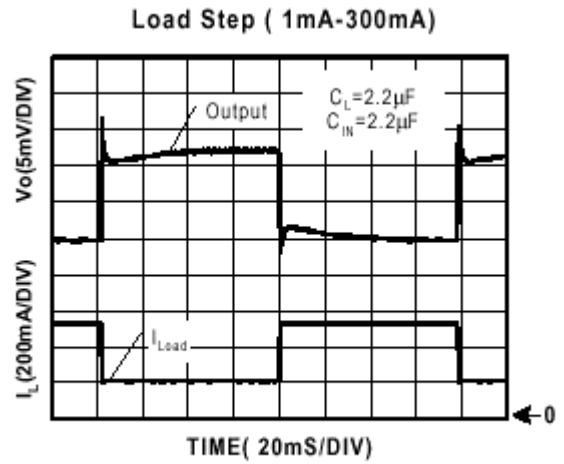
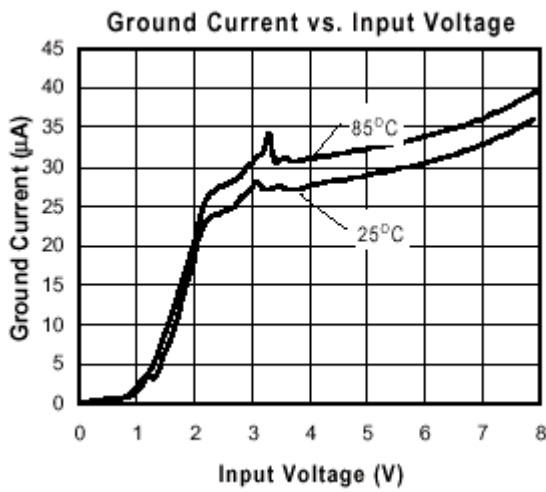

Power Supply Rejection Ratio

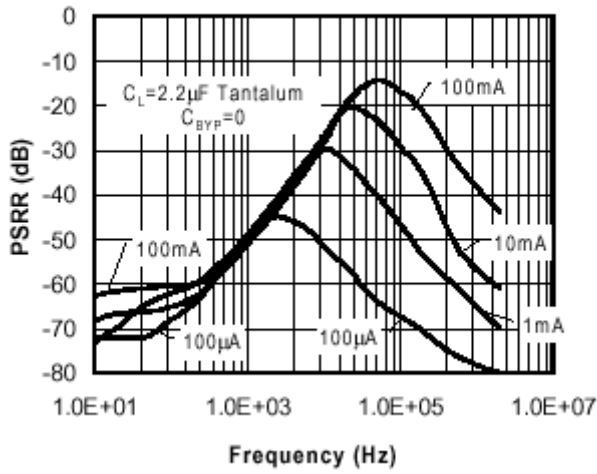

Short Circuit Response

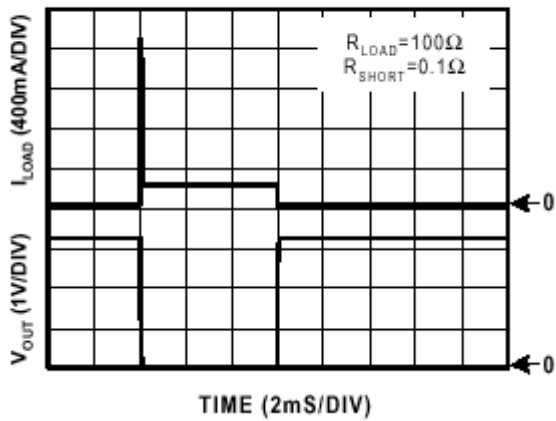

Overtemperature Shutdown

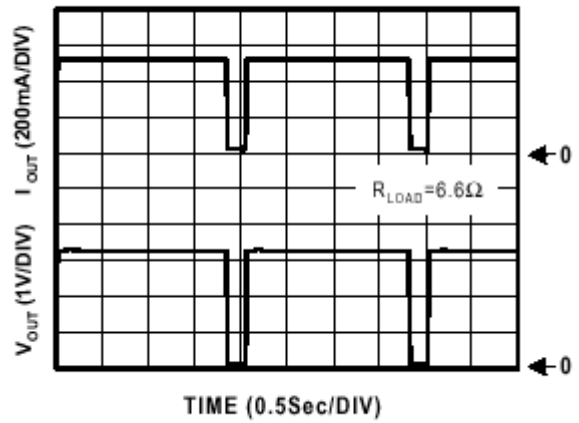

Current Limit Response

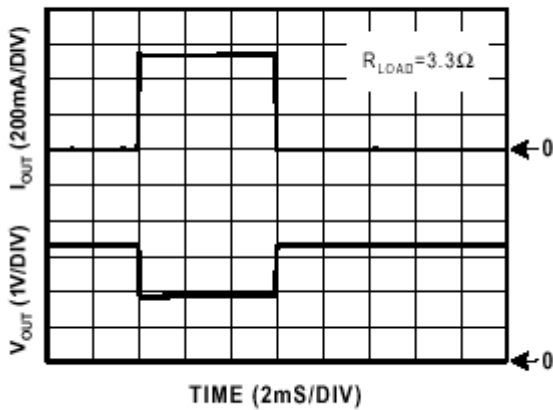

Noise Measurement

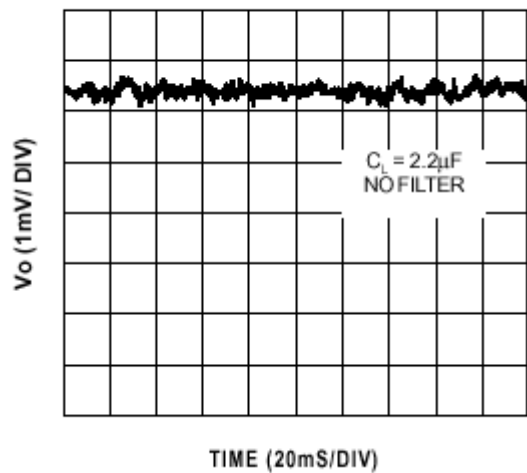

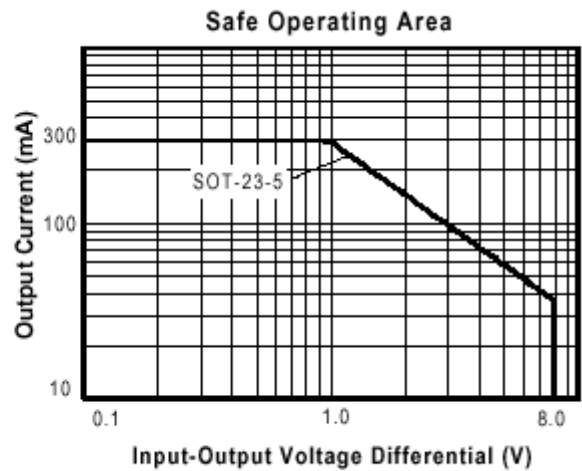
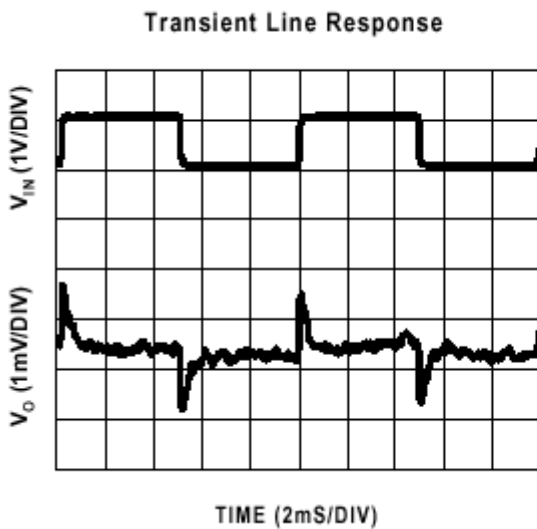
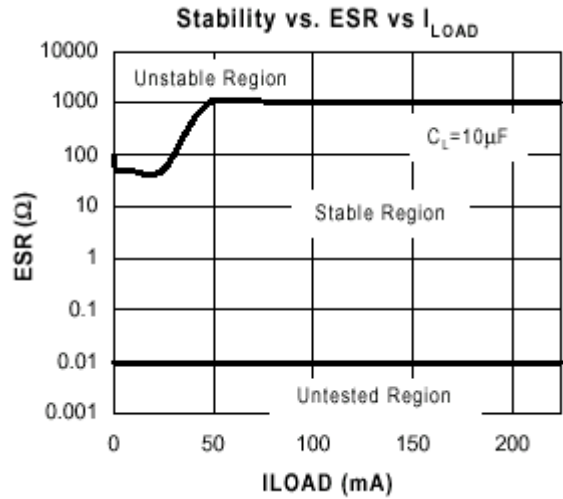
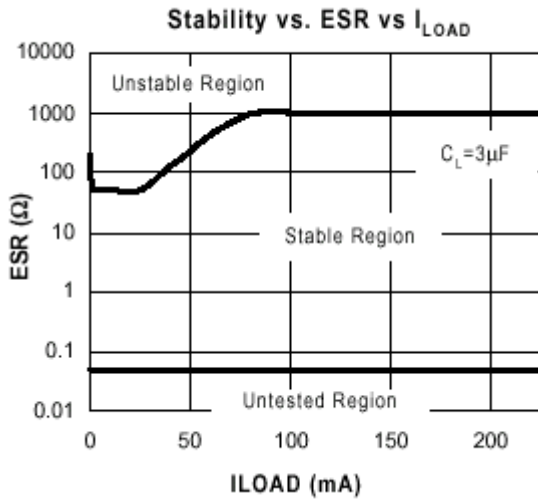
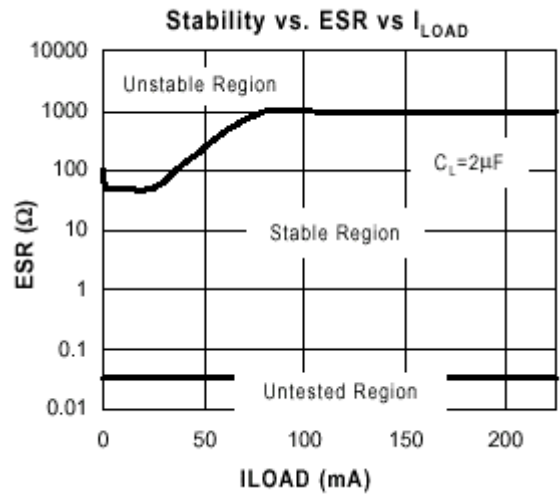
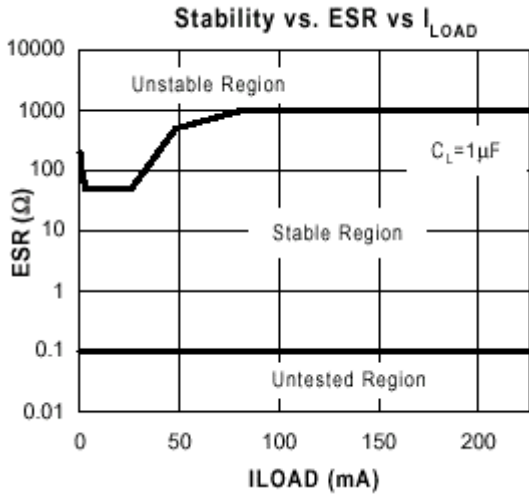

PACKAGE DIMENSION

SOT-23-5 (M25)

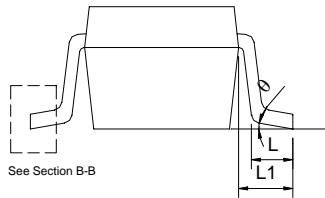
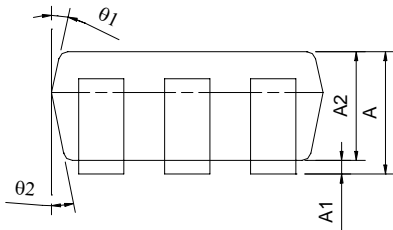
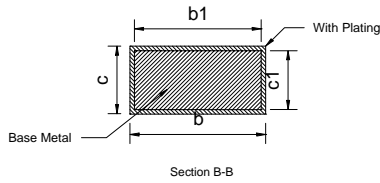
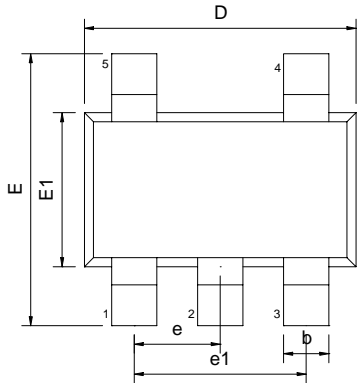

SYMBOLS	DIMENSIONS IN MILLIMETERS			DIMENSIONS IN INCHES		
	MIN	NOM	MAX	MIN	NOM	MAX
A	1.05	---	1.35	0.041	---	0.053
A1	0.05	---	0.15	0.002	---	0.006
A2	1.00	1.10	1.20	0.039	0.043	0.047
b	0.25	---	0.50	0.010	---	0.020
b1	0.25	0.40	0.45	0.010	0.016	0.018
c	0.08	---	0.20	0.003	---	0.008
c1	0.08	0.11	0.15	0.003	0.004	0.006
D	2.70	2.90	3.00	0.106	0.114	0.118
E	2.60	2.80	3.00	0.102	0.110	0.118
E1	1.50	1.60	1.70	0.059	0.063	0.067
L	0.35	0.45	0.55	0.014	0.018	0.022
L1	0.60 REF			0.024 REF		
e	0.95 BSC			0.037 BSC		
e1	1.90 BSC			0.075 BSC		
theta	0°	5°	10°	0°	5°	10°
theta1	3°	5°	7°	3°	5°	7°
theta2	6°	8°	10°	6°	8°	10°

NUMBERING SCHEME

Ordering Number: CM2843XYZ (note1)

Ordering Number: CM2843GXYZ (note2)

note1:

CM2843: 300mA CMOS LDO

X : Suffix for voltage output (note 3)

Y : Suffix for Temperature Range (note 4)

Z : Suffix for Package Type (note 5)

note2:

CM2843: 300mA CMOS LDO

G : Suffix for Pb Free Product

X : Suffix for voltage output (note 3)

Y : Suffix for Temperature Range (note 4)

Z : Suffix for Package Type (note 5)

note 3: see CMOS LDO Voltage Suffix Table

CM2843 will provide options of AC(1.2V), AB(1.3V), A(1.5V)

note 4:

Y= I : -40 ~+85 (only I grade support for all CMOS LDOs)

note 5:

Z is single alphabet with or without digits

M25 : SOT-23-5 (TR only)

CMOS LDO Voltage Suffix Table

Output Voltage	Suffix	Output Voltage	Suffix
1.2V	AC	2.7V	M
1.3V	AB	2.8V	N
1.4V	AA	2.9V	O
1.5V	A	3.0V	P
1.6V	B	3.1V	Q
1.7V	C	3.2V	R
1.8V	D	3.3V	S
1.9V	E	3.4V	T
2.0V	F	3.5V	U
2.1V	G	3.6V	V
2.2V	H	3.7V	W
2.3V	I	3.8V	X
2.4V	J	3.9V	Y
2.5V	K	4.0V	Z
2.6V	L		

IMPORTANT NOTICE

Champion Microelectronic Corporation (CMC) reserves the right to make changes to its products or to discontinue any integrated circuit product or service without notice, and advises its customers to obtain the latest version of relevant information to verify, before placing orders, that the information being relied on is current.

A few applications using integrated circuit products may involve potential risks of death, personal injury, or severe property or environmental damage. CMC integrated circuit products are not designed, intended, authorized, or warranted to be suitable for use in life-support applications, devices or systems or other critical applications. Use of CMC products in such applications is understood to be fully at the risk of the customer. In order to minimize risks associated with the customer's applications, the customer should provide adequate design and operating safeguards.

HsinChu Headquarter

5F, No. 11, Park Avenue II,
Science-Based Industrial Park,
HsinChu City, Taiwan
TEL: +886-3-567 9979
FAX: +886-3-567 9909

Sales & Marketing

11F, No. 306-3, SEC. 1, Ta Tung Road,
Hsichih, Taipei Hsien 221, Taiwan
TEL: +886-2-8692 1591
FAX: +886-2-8692 1596
