



Micro Commercial Components
 21201 Itasca Street Chatsworth
 CA 91311
 Phone: (818) 701-4933
 Fax: (818) 701-4939

UPS120 THRU UPS140

Features

- High Power Surface Mount Package
- Guard Ring Protection
- Low Forward Voltage
- Integral Heat Sink/Locking Tabs
- Compatible with Automatic Insertion Equipment

Maximum Ratings

- Operating Temperature: -55°C to +150°C
- Storage Temperature: -55°C to +150°C
- Maximum Thermal Resistance; 23°C/W Junction To Tab
- Maximum Thermal Resistance; 10°C/W Junction To Bottom

MCC Catalog Number	Device Marking	Maximum Recurrent Peak Reverse Voltage	Maximum RMS Voltage	Maximum DC Blocking Voltage
UPS120	BCF	20V	14V	20V
UPS130	BCG	30V	21V	30V
UPS140	BCJ	40V	28V	40V

1 Amp Schottky Rectifier 20 to 40 Volts

DO-216AA (POWERMITE™)

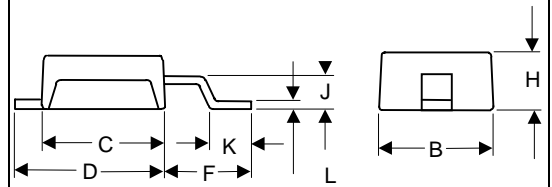
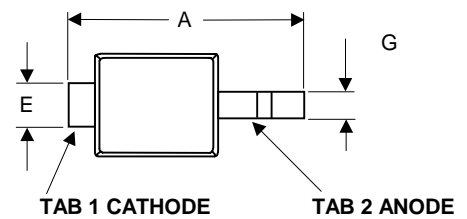

Electrical Characteristics @ 25°C Unless Otherwise Specified

Average Forward Current	$I_{F(AV)}$	1.0A	$T_J = 135^\circ\text{C}$
Peak Forward Surge Current	I_{FSM}	50A	8.3ms, half sine
Maximum Instantaneous Forward Voltage UPS120 UPS130 UPS140	V_F	.45 V .55 V .55 V	$I_{FM} = 1.0A;$ $T_J = 25^\circ\text{C}^*$
Maximum DC Reverse Current At Rated DC Blocking Voltage UPS120 UPS130 UPS140	I_R	.40/25mA .41/11mA .50/25mA	$T_J = 25^\circ\text{C}$ $T_J = 85^\circ\text{C}$ $V_R = 20V$ $V_R = 30V$ $V_R = 40V$

*Pulse test: Pulse width 200 μsec , Duty cycle 2%

DIM	DIMENSIONS				NOTE
	INCHES		MM		
A	.143	.153	3.63	3.89	
B	.070	.080	1.78	2.03	
C	.070	.080	1.78	2.03	
D	.087	.097	2.21	2.46	
E	.029	.039	0.74	0.99	
F	.051	.061	1.30	1.55	
G	----	.026	----	0.66	
H	.035	.045	0.89	1.14	
J	.021	.031	0.53	0.79	
K	----	.025	----	0.64	
L	----	.006	----	0.15	

NOTE: POWERMITE™ package is patental by microsemi corp.

Figure 1
Typical Forward Characteristics

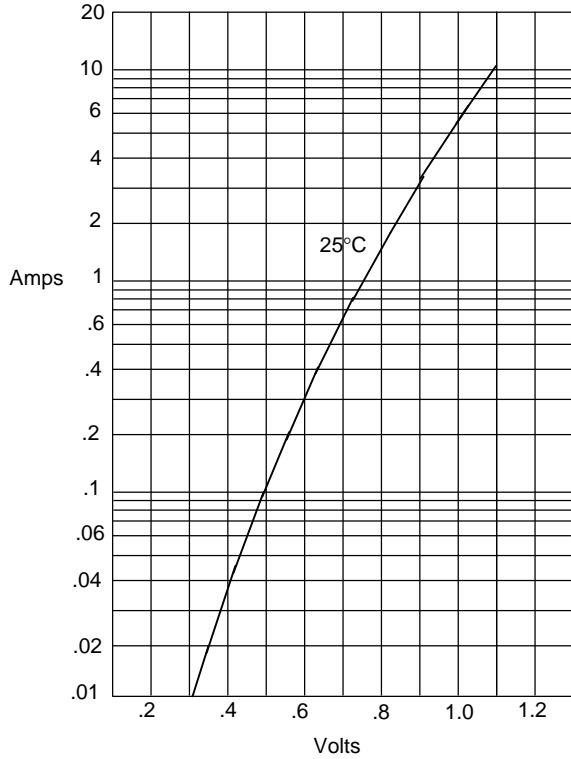

Instantaneous Forward Current - Amperes versus Instantaneous Forward Voltage - Volts

Figure 2
Forward Derating Curve

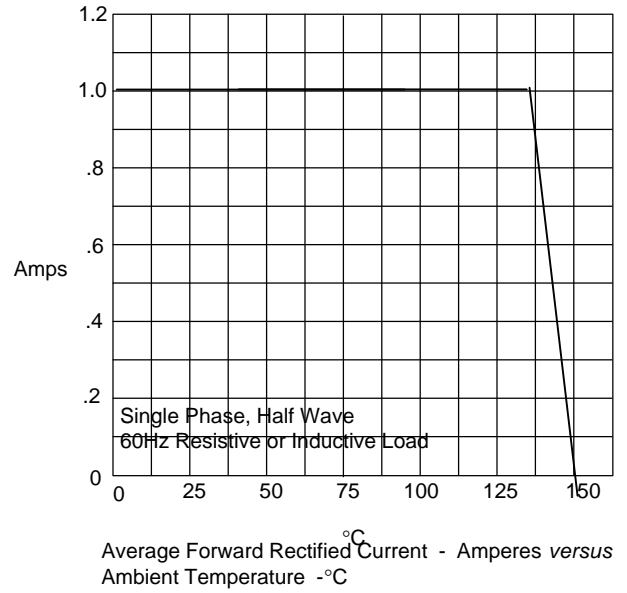

Average Forward Rectified Current - Amperes versus Ambient Temperature - °C

Figure 3
Junction Capacitance

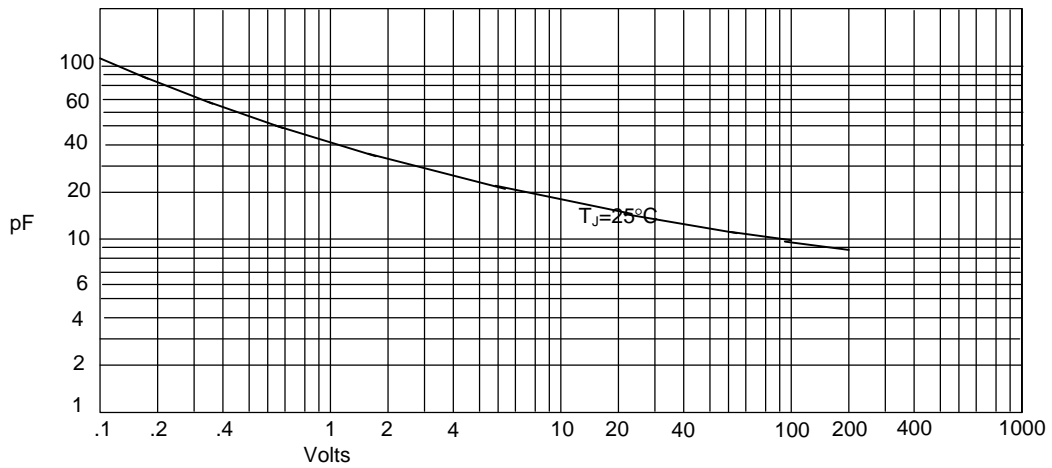

Junction Capacitance - pF versus Reverse Voltage - Volts

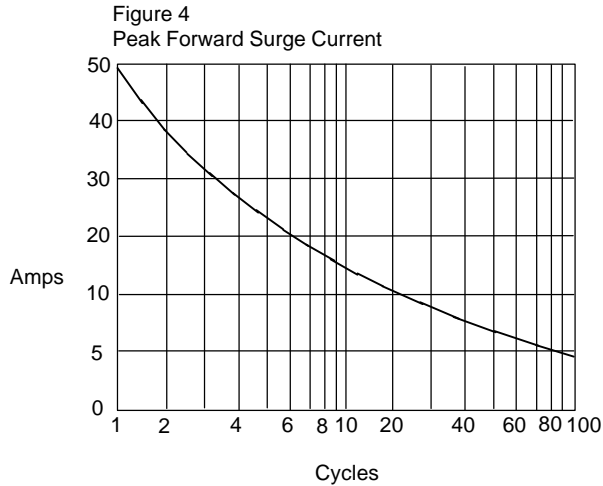

Peak Forward Surge Current - Amperes *versus* Number Of Cycles At 60Hz - Cycles

Figure 6
Reverse Recovery Time Characteristic And Test Circuit Diagram

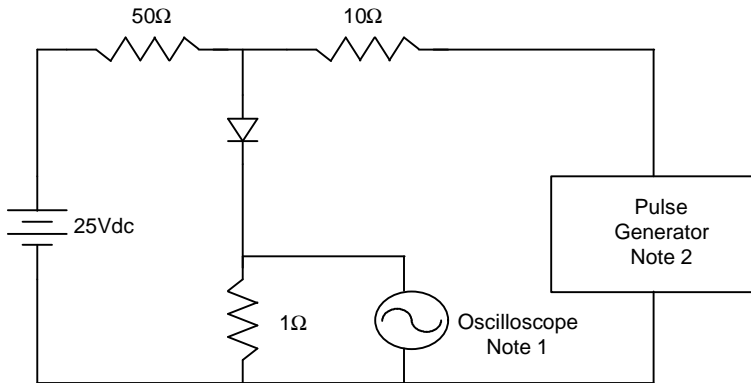

Notes:

1. Rise Time = 7ns max.
Input impedance = 1 megohm, 22pF
2. Rise Time = 10ns max.
Source impedance = 50 ohms
3. Resistors are non-inductive

