

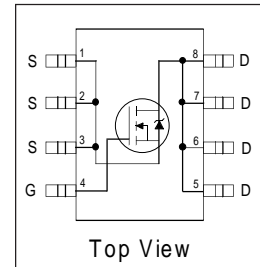
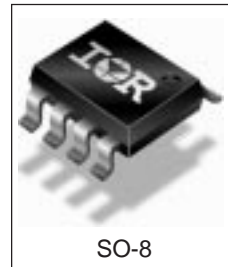
- N-Channel Application-Specific MOSFETs
- Ideal for CPU Core DC-DC Converters
- Low Conduction Losses
- Low Switching Losses
- Minimizes Parallel MOSFETs for high current applications

**Description**

This new device employs advanced HEXFET Power MOSFET technology to achieve an unprecedented balance of on-resistance and gate charge. The reduced conduction and switching losses make it ideal for high efficiency DC-DC converters that power the latest generation of microprocessors.

The IRF7809AV has been optimized for all parameters that are critical in synchronous buck converters including  $R_{DS(on)}$ , gate charge and Cdv/dt-induced turn-on immunity. The IRF7809AV offers particularly low  $R_{DS(on)}$  and high Cdv/dt immunity for synchronous FET applications.

The package is designed for vapor phase, infra-red, convection, or wave soldering techniques. Power dissipation of greater than 2W is possible in a typical PCB mount application.



**DEVICE CHARACTERISTICS** ⑤

	<b>IRF7809AV</b>
$R_{DS(on)}$	7.0mΩ
$Q_G$	41nC
$Q_{sw}$	14nC
$Q_{oss}$	30nC

**Absolute Maximum Ratings**

Parameter	Symbol	IRF7809A V	Units
Drain-Source Voltage	$V_{DS}$	30	V
Gate-Source Voltage	$V_{GS}$	±12	
Continuous Drain or Source Current ( $V_{GS} \geq 4.5V$ )	$I_D$	$T_A = 25^\circ C$	13.3
		$T_L = 90^\circ C$	14.6
Pulsed Drain Current①	$I_{DM}$	100	A
Power Dissipation	$P_D$	$T_A = 25^\circ C$	2.5
		$T_L = 90^\circ C$	3.0
Junction & Storage Temperature Range	$T_J, T_{STG}$	-55 to 150	°C
Continuous Source Current (Body Diode)	$I_S$	2.5	A
Pulsed Source Current①	$I_{SM}$	50	

**Thermal Resistance**

Parameter		Max.	Units
Maximum Junction-to-Ambient③	$R_{\theta JA}$	50	°C/W
Maximum Junction-to-Lead	$R_{\theta JL}$	20	°C/W

## Electrical Characteristics

Parameter		Min	Typ	Max	Units	Conditions
Drain-to-Source Breakdown Voltage	$BV_{DSS}$	30	–	–	V	$V_{GS} = 0V, I_D = 250\mu A$
Static Drain-Source on Resistance	$R_{DS(on)}$		7.0	9.0	$m\Omega$	$V_{GS} = 4.5V, I_D = 15A$ Ⓞ
Gate Threshold Voltage	$V_{GS(th)}$	1.0			V	$V_{DS} = V_{GS}, I_D = 250\mu A$
Drain-Source Leakage Current	$I_{DSS}$			30	$\mu A$	$V_{DS} = 24V, V_{GS} = 0$
				150		$V_{DS} = 24V, V_{GS} = 0,$ $T_j = 100^\circ C$
Gate-Source Leakage Current*	$I_{GSS}$			$\pm 100$	nA	$V_{GS} = \pm 12V$
Total Gate Chg Cont FET	$Q_G$		41	62	nC	$V_{GS}=5V, I_D=15A, V_{DS}=20V$
Total Gate Chg Sync FET	$Q_G$		36	54		$V_{GS} = 5V, V_{DS} < 100mV$
Pre-Vth Gate-Source Charge	$Q_{GS1}$		7.0			$V_{DS} = 20V, I_D = 15A$
Post-Vth Gate-Source Charge	$Q_{GS2}$		2.3			
Gate to Drain Charge	$Q_{GD}$		12			$I_D=15A, V_{DS}=16V$
Switch Chg( $Q_{gs2} + Q_{gd}$ )	$Q_{sw}$		14	21		
Output Charge*	$Q_{OSS}$		30	45		$V_{DS} = 16V, V_{GS} = 0$
Gate Resistance	$R_G$		1.5			$\Omega$
Turn-on Delay Time	$t_{d(on)}$		14		ns	$V_{DD} = 16V, I_D = 15A$ $V_{GS} = 5V$ Clamped Inductive Load
Rise Time	$t_r$		36			
Turn-off Delay Time	$t_{d(off)}$		96			
Fall Time	$t_f$		10			
Input Capacitance	$C_{ISS}$	–	3780	–	pF	$V_{DS} = 16V, V_{GS} = 0$
Output Capacitance	$C_{OSS}$	–	1060	–		
Reverse Transfer Capacitance	$C_{RSS}$	–	130	–		

## Source-Drain Rating & Characteristics

Parameter		Min	Typ	Max	Units	Conditions
Diode Forward Voltage*	$V_{SD}$			1.3	V	$I_S = 15A$ Ⓞ, $V_{GS} = 0V$
Reverse Recovery Charge④	$Q_{rr}$		120		nC	$di/dt \sim 700A/\mu s$ $V_{DS} = 16V, V_{GS} = 0V, I_S = 15A$
Reverse Recovery Charge (with Parallel Schottky)④	$Q_{rr(s)}$		150		nC	$di/dt = 700A/\mu s$ (with 10BQ040) $V_{DS} = 16V, V_{GS} = 0V, I_S = 15A$

- Notes:**
- ① Repetitive rating; pulse width limited by max. junction temperature.
  - ② Pulse width  $\leq 400 \mu s$ ; duty cycle  $\leq 2\%$ .
  - ③ When mounted on 1 inch square copper board,  $t < 10$  sec.
  - ④ Typ = measured -  $Q_{OSS}$
  - ⑤ Typical values measured at  $V_{GS} = 4.5V, I_F = 15A$ .

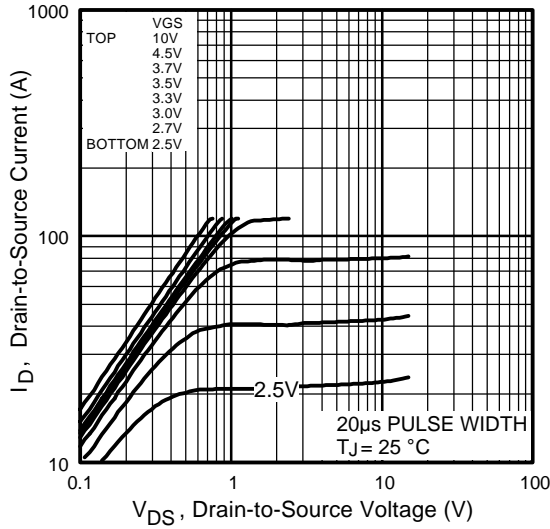


Fig 1. Typical Output Characteristics

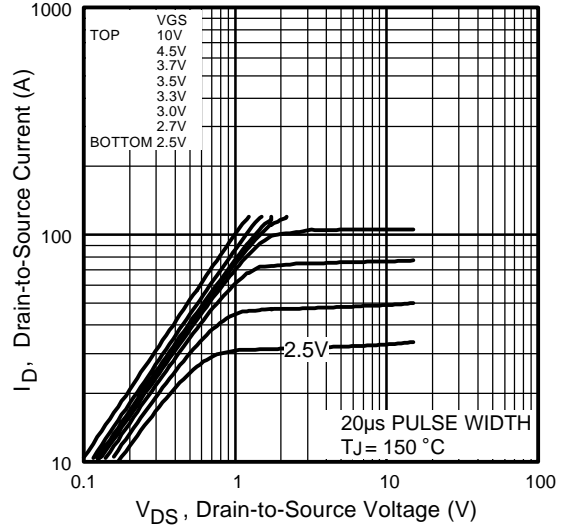


Fig 2. Typical Output Characteristics

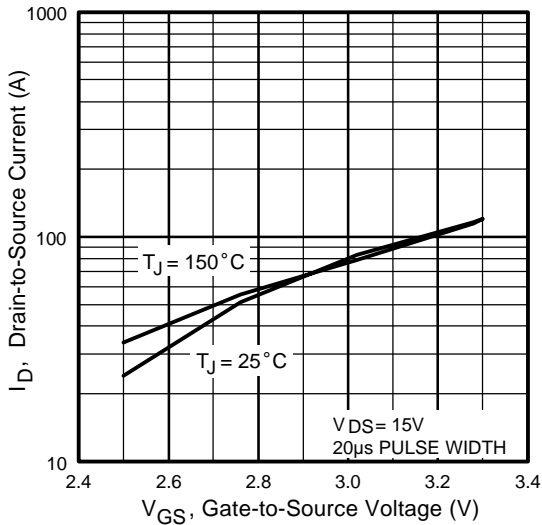


Fig 3. Typical Transfer Characteristics

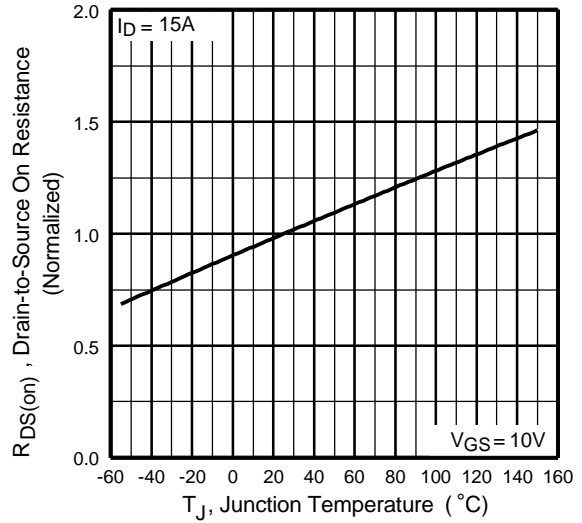
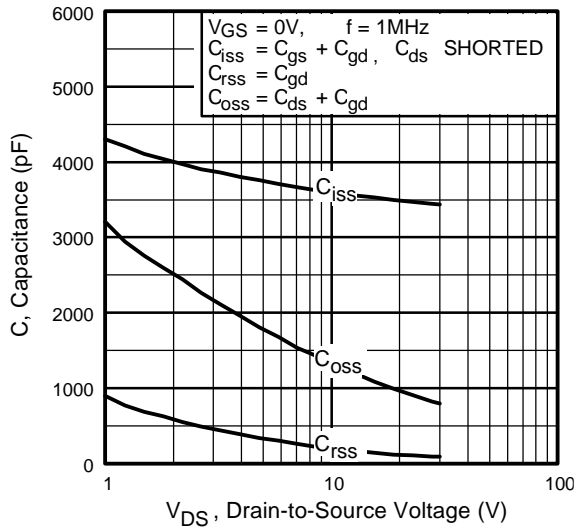
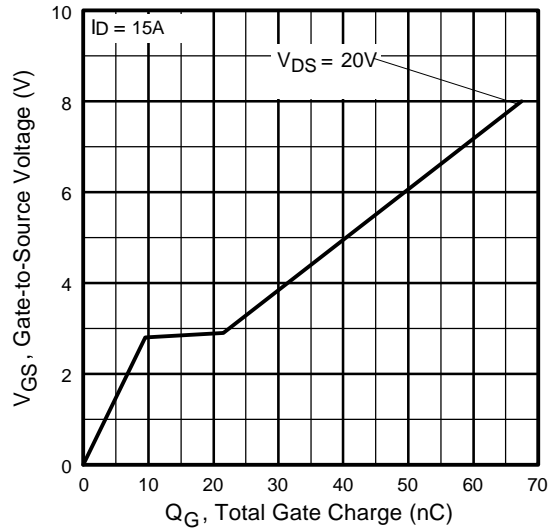


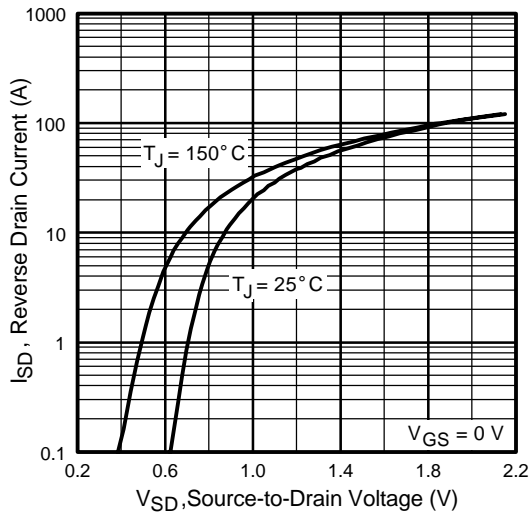
Fig 4. Normalized On-Resistance Vs. Temperature



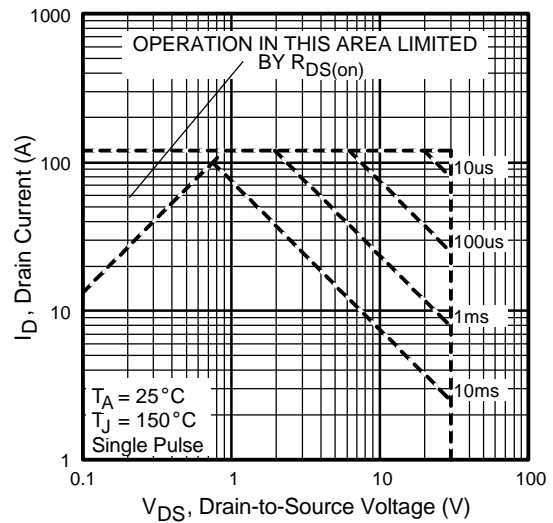
**Fig 5.** Typical Capacitance Vs. Drain-to-Source Voltage



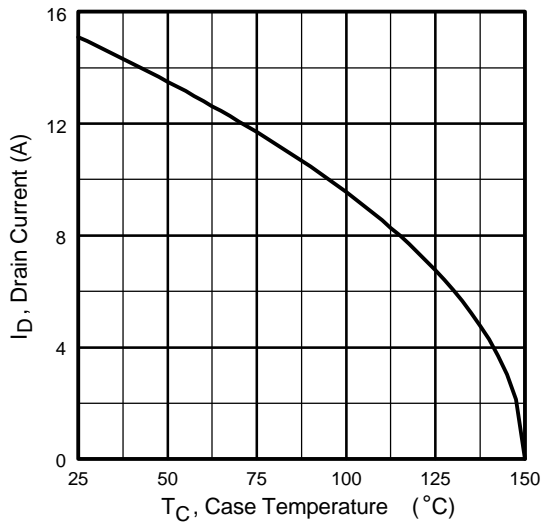
**Fig 6.** Typical Gate Charge Vs. Gate-to-Source Voltage



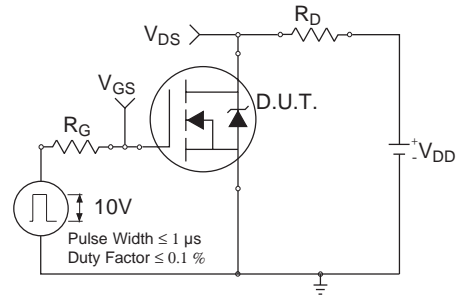
**Fig 7.** Typical Source-Drain Diode Forward Voltage



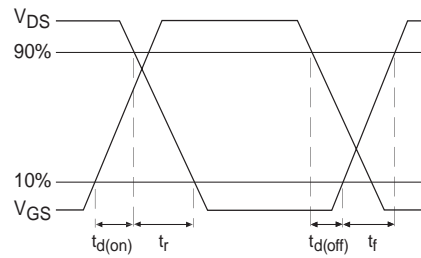
**Fig 8.** Maximum Safe Operating Area



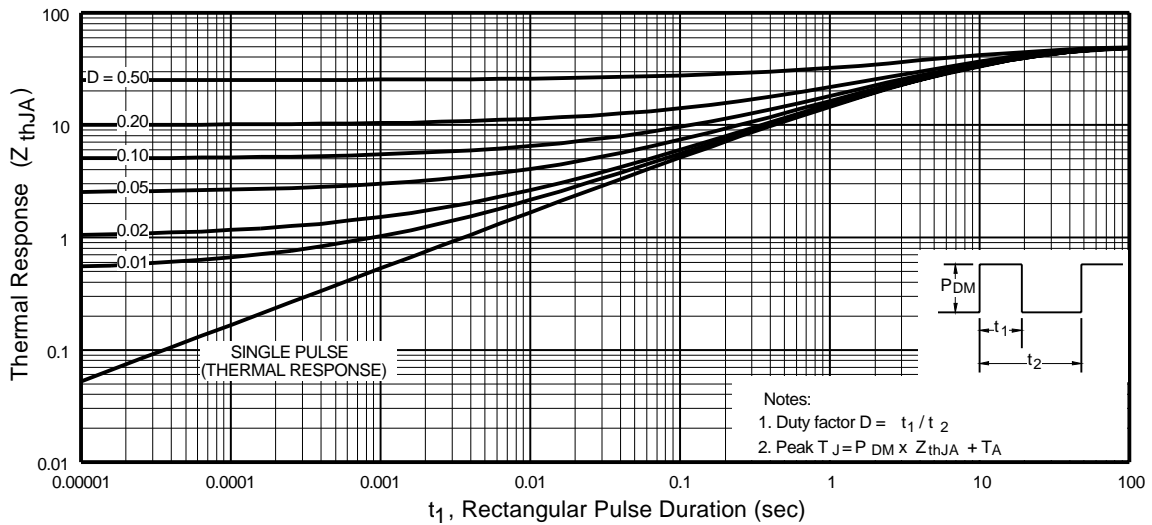
**Fig 9.** Maximum Drain Current Vs. Case Temperature



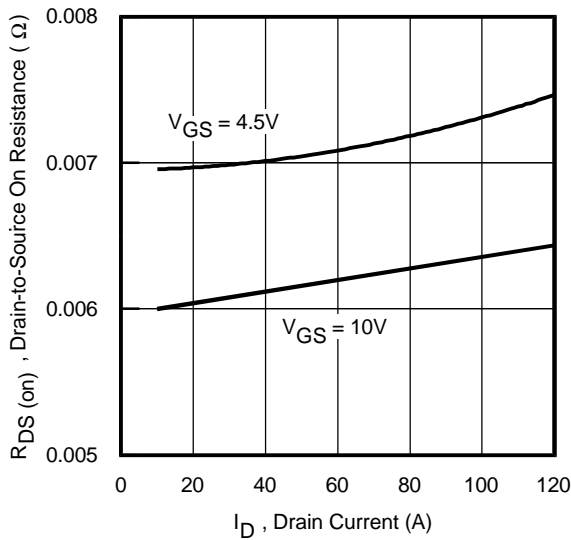
**Fig 10a.** Switching Time Test Circuit



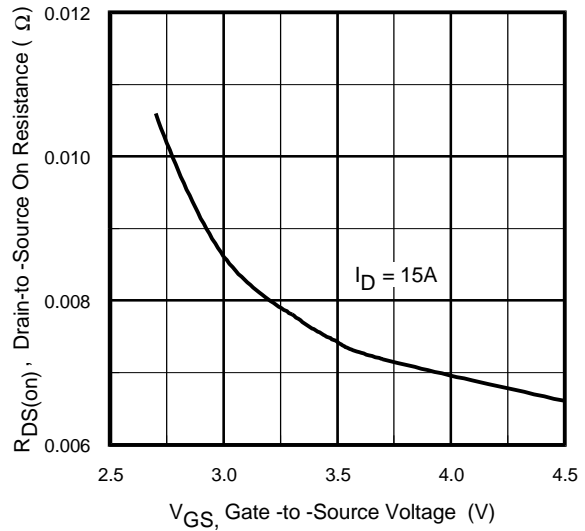
**Fig 10b.** Switching Time Waveforms



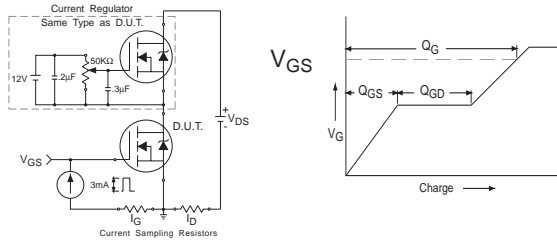
**Fig 11.** Maximum Effective Transient Thermal Impedance, Junction-to-Ambient



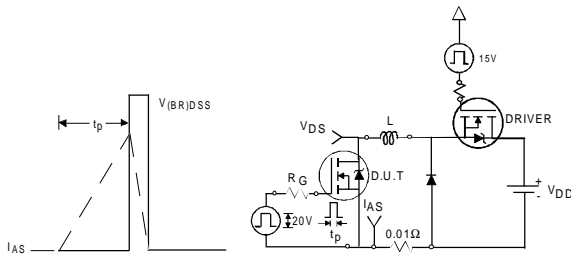
**Fig 12.** On-Resistance Vs. Drain Current



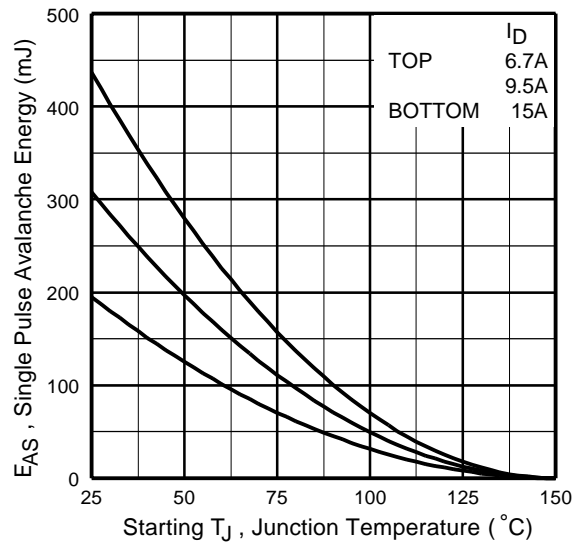
**Fig 13.** On-Resistance Vs. Gate Voltage



**Fig 13a&b.** Basic Gate Charge Test Circuit and Waveform

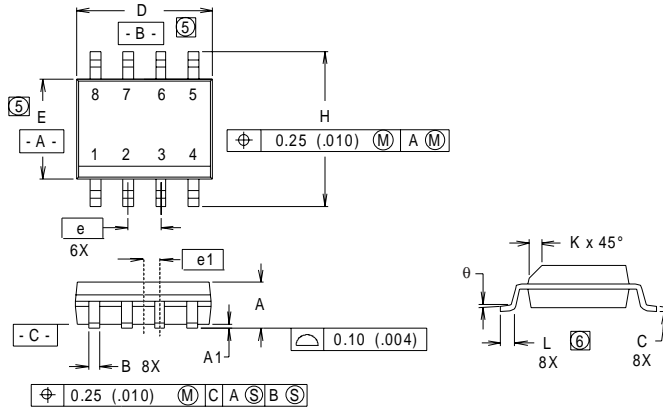


**Fig 14a&b.** Unclamped Inductive Test circuit and Waveforms



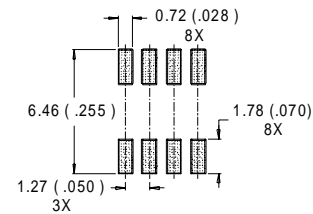
**Fig 14c.** Maximum Avalanche Energy Vs. Drain Current

## SO-8 Package Details



DIM	INCHES		MILLIMETERS	
	MIN	MAX	MIN	MAX
A	.0532	.0688	1.35	1.75
A1	.0040	.0098	0.10	0.25
B	.014	.018	0.36	0.46
C	.0075	.0098	0.19	0.25
D	.189	.196	4.80	4.98
E	.150	.157	3.81	3.99
e	.050 BASIC		1.27 BASIC	
e1	.025 BASIC		0.635 BASIC	
H	.2284	.2440	5.80	6.20
K	.011	.019	0.28	0.48
L	0.16	.050	0.41	1.27
$\theta$	0°	8°	0°	8°

### RECOMMENDED FOOTPRINT

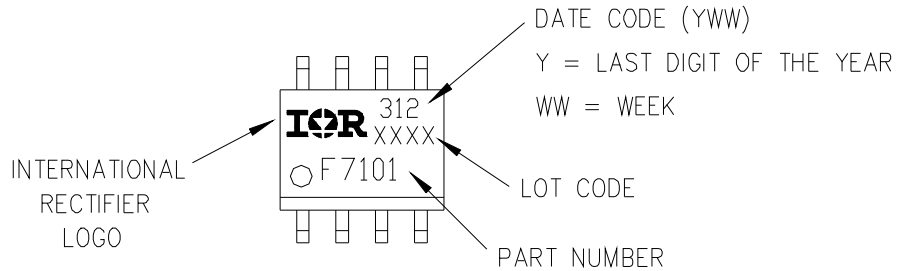


### NOTES:

1. DIMENSIONING AND TOLERANCING PER ANSI Y14.5M-1982.
2. CONTROLLING DIMENSION : INCH.
3. DIMENSIONS ARE SHOWN IN MILLIMETERS (INCHES).
4. OUTLINE CONFORMS TO JEDEC OUTLINE MS-012AA.
- ⑤ DIMENSION DOES NOT INCLUDE MOLD PROTRUSIONS  
MOLD PROTRUSIONS NOT TO EXCEED 0.25 (.006).
- ⑥ DIMENSIONS IS THE LENGTH OF LEAD FOR SOLDERING TO A SUBSTRATE..

## SO-8 Part Marking

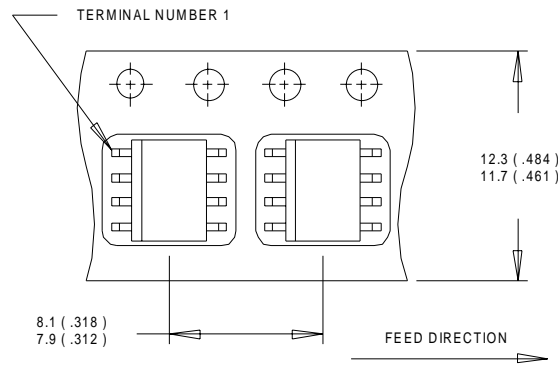
EXAMPLE: THIS IS AN IRF7101



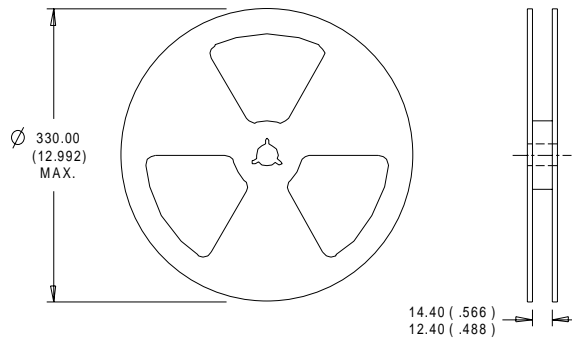
# IRF7809AV

International  
**IR** Rectifier

## SO-8 Tape and Reel



- NOTES:
1. CONTROLLING DIMENSION : MILLIMETER.
  2. ALL DIMENSIONS ARE SHOWN IN MILLIMETERS(INCHES).
  3. OUTLINE CONFORMS TO EIA-481 & EIA-541.



- NOTES :
1. CONTROLLING DIMENSION : MILLIMETER.
  2. OUTLINE CONFORMS TO EIA-481 & EIA-541.

International  
**IR** Rectifier

**IR WORLD HEADQUARTERS:** 233 Kansas St., El Segundo, California 90245, USA Tel: (310) 252-7105  
**IR EUROPEAN REGIONAL CENTER:** 439/445 Godstone Rd, Whyteleafe, Surrey CR3 OBL, UK Tel: ++ 44 (0)20 8645 8000

**IR CANADA:** 15 Lincoln Court, Brampton, Ontario L6T3Z2, Tel: (905) 453 2200

**IR GERMANY:** Saalburgstrasse 157, 61350 Bad Homburg Tel: ++ 49 (0) 6172 96590

**IR ITALY:** Via Liguria 49, 10071 Borgaro, Torino Tel: ++ 39 011 451 0111

**IR JAPAN:** K&H Bldg., 2F, 30-4 Nishi-Ikebukuro 3-Chome, Toshima-Ku, Tokyo 171 Tel: 81 (0)3 3983 0086

**IR SOUTHEAST ASIA:** 1 Kim Seng Promenade, Great World City West Tower, 13-11, Singapore 237994 Tel: ++ 65 (0)838 4630

**IR TAIWAN:** 16 Fl. Suite D. 207, Sec. 2, Tun Haw South Road, Taipei, 10673 Tel: 886-(0)2 2377 9936

*Data and specifications subject to change without notice. 10/00*