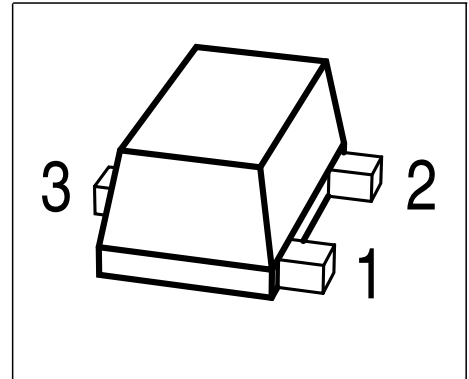

**NPN Silicon RF Transistor**

Preliminary data

- Low voltage/ low current operation
- Transition frequency of 14 GHz
- High insertion gain
- Ideal for low current amplifiers and oscillators

**ESD: Electrostatic discharge sensitive device, observe handling precaution!**

Type	Marking	Pin Configuration			Package
BFR340F	FAs	1 = B	2 = E	3 = C	TSFP-3

**Maximum Ratings**

Parameter	Symbol	Value	Unit
Collector-emitter voltage	$V_{CEO}$	6	V
Collector-emitter voltage	$V_{CES}$	15	
Collector-base voltage	$V_{CBO}$	15	
Emitter-base voltage	$V_{EBO}$	2	
Collector current	$I_C$	10	mA
Base current	$I_B$	2	
Total power dissipation <sup>1)</sup> $T_S \leq 118^\circ\text{C}$	$P_{tot}$	60	mW
Junction temperature	$T_j$	150	°C
Ambient temperature	$T_A$	-65 ... 150	
Storage temperature	$T_{stg}$	-65 ... 150	

**Thermal Resistance**

Parameter	Symbol	Value	Unit
Junction - soldering point <sup>2)</sup>	$R_{thJS}$	$\leq 530$	K/W

<sup>1)</sup> $T_S$  is measured on the collector lead at the soldering point to the pcb

<sup>2)</sup>For calculation of  $R_{thJA}$  please refer to Application Note Thermal Resistance

**Electrical Characteristics** at  $T_A = 25^\circ\text{C}$ , unless otherwise specified

Parameter	Symbol	Values			Unit
		min.	typ.	max.	
<b>Characteristics</b>					
Collector-emitter breakdown voltage $I_C = 1 \text{ mA}, I_B = 0$	$V_{(BR)CEO}$	6	9	-	V
Collector-emitter cutoff current $V_{CE} = 15 \text{ V}, V_{BE} = 0$	$I_{CES}$	-	-	10	$\mu\text{A}$
Collector-base cutoff current $V_{CB} = 5 \text{ V}, I_E = 0$	$I_{CBO}$	-	-	100	nA
Emitter-base cutoff current $V_{EB} = 1 \text{ V}, I_C = 0$	$I_{EBO}$	-	-	1	$\mu\text{A}$
DC current gain- $I_C = 5 \text{ mA}, V_{CE} = 3 \text{ V}$	$h_{FE}$	60	130	200	-

**Electrical Characteristics at  $T_A = 25^\circ\text{C}$ , unless otherwise specified**

Parameter	Symbol	Values			Unit
		min.	typ.	max.	
<b>AC Characteristics</b> (verified by random sampling)					
Transition frequency $I_C = 6\text{ mA}$ , $V_{CE} = 3\text{ V}$ , $f = 1\text{ GHz}$	$f_T$	11	14	-	GHz
Collector-base capacitance $V_{CB} = 5\text{ V}$ , $f = 1\text{ MHz}$ , emitter grounded	$C_{cb}$	-	0.21	0.4	pF
Collector emitter capacitance $V_{CE} = 5\text{ V}$ , $f = 1\text{ MHz}$ , base grounded	$C_{ce}$	-	0.17	-	
Emitter-base capacitance $V_{EB} = 0.5\text{ V}$ , $f = 1\text{ MHz}$ , collector grounded	$C_{eb}$	-	0.11	-	
Noise figure $I_C = 1\text{ mA}$ , $V_{CE} = 3\text{ V}$ , $Z_S = Z_{Sopt}$ , $f = 1.8\text{ GHz}$	$F_{min}$	-	1.15	-	dB
Power gain, maximum stable <sup>1)</sup> $I_C = 5\text{ mA}$ , $V_{CE} = 3\text{ V}$ , $Z_S = Z_{Sopt}$ , $Z_L = Z_{Lopt}$ , $f = 1.8\text{ GHz}$	$G_{ms}$	-	16	-	-
Power gain, maximum available <sup>1)</sup> $I_C = 5\text{ mA}$ , $V_{CE} = 3\text{ V}$ , $Z_S = Z_{Sopt}$ , $Z_L = Z_{Lopt}$ , $f = 3\text{ GHz}$	$G_{ma}$	-	12	-	dB
Transducer gain $I_C = 5\text{ mA}$ , $V_{CE} = 3\text{ V}$ , $Z_S = Z_L = 50\Omega$ , $f = 1.8\text{ GHz}$ $I_C = 5\text{ mA}$ , $V_{CE} = 3\text{ V}$ , $Z_S = Z_L = 50\Omega$ , $f = 3\text{ GHz}$	$ S_{21e} ^2$	-	13	-	dB
		-	9.5	-	
Third order intercept point at output <sup>2)</sup> $V_{CE} = 3\text{ V}$ , $I_C = 5\text{ mA}$ , $f = 1.8\text{ GHz}$ , $Z_S = Z_L = 50\Omega$	$IP_3$	-	13	-	dBm
1dB Compression point at output $I_C = 5\text{ mA}$ , $V_{CE} = 3\text{ V}$ , $Z_S = Z_L = 50\Omega$ , $f = 1.8\text{ GHz}$	$P_{-1dB}$	-	0	-	

$$^1G_{ma} = |S_{21e} / S_{12e}| (k - (k^2 - 1)^{1/2}), G_{ms} = |S_{21e} / S_{12e}|$$

<sup>2)</sup> $IP_3$  value depends on termination of all intermodulation frequency components.  
Termination used for this measurement is  $50\Omega$  from 0.1 MHz to 6 GHz

**SPICE Parameter (Gummel-Poon Model, Berkley-SPICE 2G.6 Syntax):**

**Transistor Chip Data:**

IS =	6.12	fA	BF =	98.48	-	NF =	0.4213	-
VAF =	42.228	V	IKF =	103	mA	ISE =	11.768	nA
NE =	2.4753	-	BR =	19.61	-	NR =	0.3253	-
VAR =	16.777	V	IKR =	0.834	A	ISC =	3.632	nA
NC =	0.8956	-	RB =	59.99	$\Omega$	IRB =	0.01	mA
RBM =	0.2403	$\Omega$	RE =	3.677	-	RC =	5.2493	$\Omega$
CJE =	182	fF	VJE =	0.626	V	MJE =	0.4172	-
TF =	10.3	ps	XTF =	0	-	VTF =	0.262	V
ITF =	0.0017	mA	PTF =	0	deg	CJC =	222.63	fF
VJC =	0.5487	V	MJC =	0.319	-	XCJC =	0.3904	-
TR =	2.71	ns	CJS =	0	fF	VJS =	0.75	V
MJS =	0	-	NK =	0.5	-	EG =	1.11	eV
XTI =	0	-	FC =	0.735	-	TNOM	300	K

All parameters are ready to use, no scaling is necessary. Extracted on behalf of Infineon Technologies AG by: Institut für Mobil- und Satellitentechnik (IMST)

**Package Equivalent Circuit:**

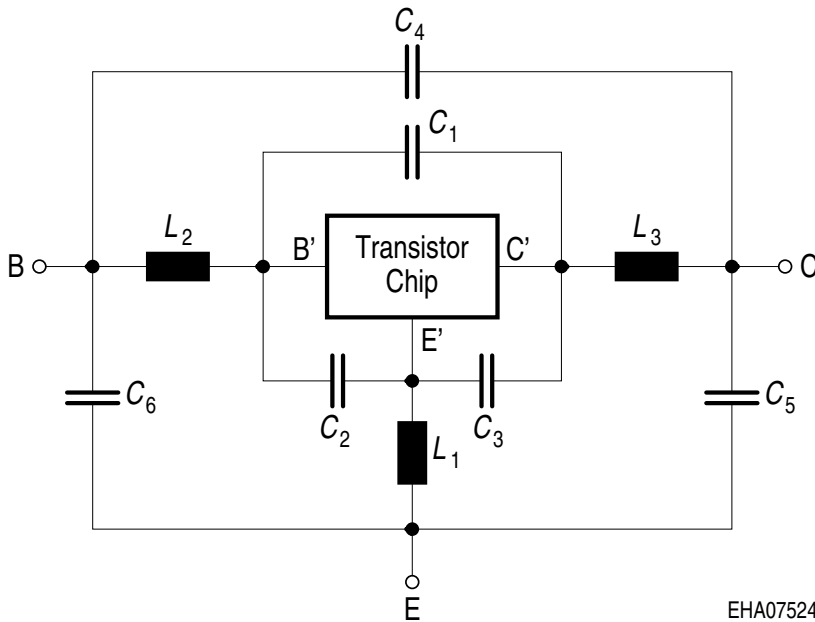

$L_1 =$	0.556	nH
$L_2 =$	0.657	nH
$L_3 =$	0.381	nH
$C_1 =$	43	fF
$C_2 =$	123	fF
$C_3 =$	66	fF
$C_4 =$	10	fF
$C_5 =$	36	fF
$C_6 =$	47	fF

Valid up to 6GHz

EHA07524

For examples and ready to use parameters please contact your local Infineon Technologies distributor or sales office to obtain a Infineon Technologies CD-ROM or see Internet: <http://www.infineon.com/silicondiscretres>

**Total power dissipation  $P_{tot} = f(T_S)$**

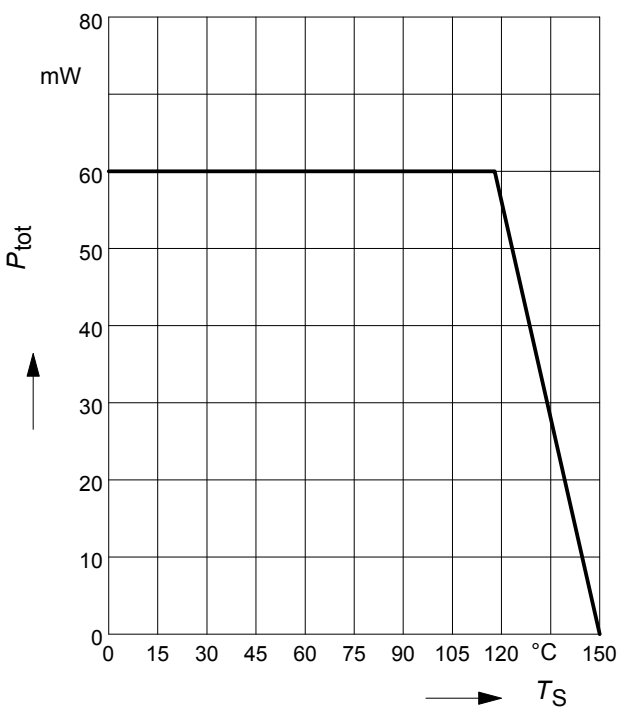

**Permissible Pulse Load  $R_{thJS} = f(t_p)$**

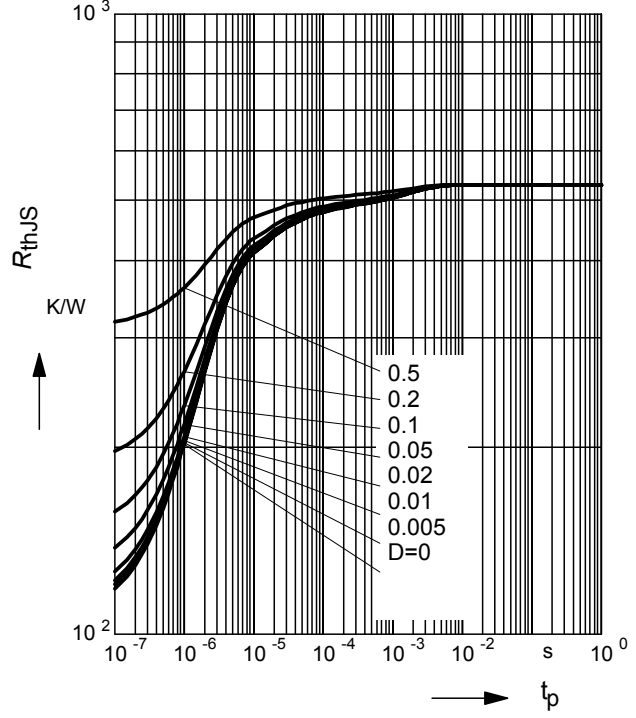

**Permissible Pulse Load**

$P_{totmax}/P_{totDC} = f(t_p)$

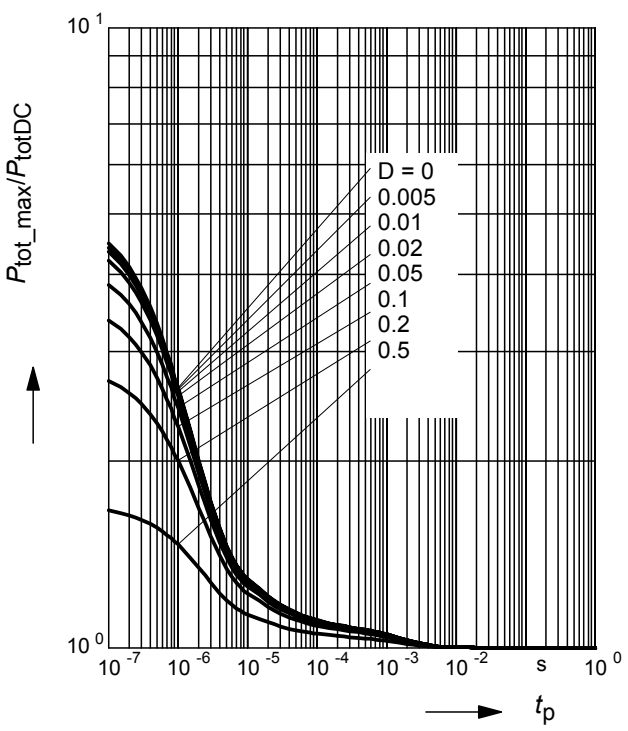

**Collector-base capacitance  $C_{cb} = f(V_{CB})$**

$f = 1\text{MHz}$

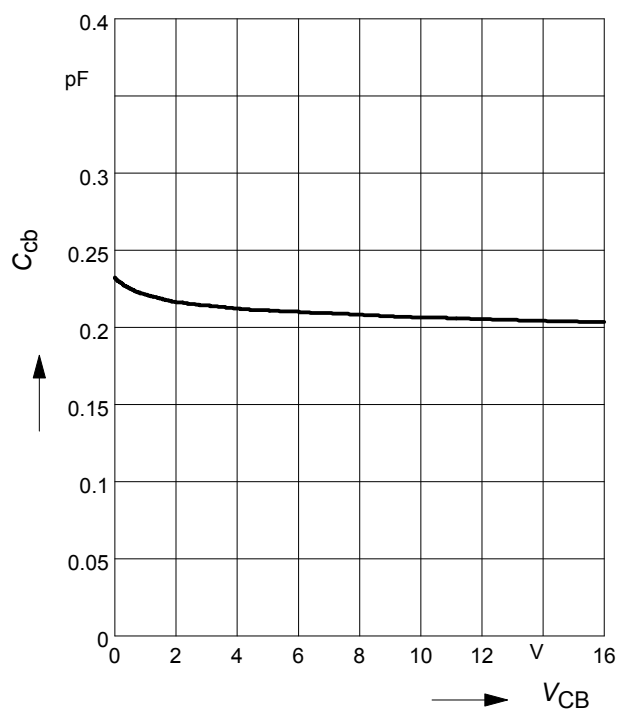

**Third order Intercept Point  $IP_3 = f(I_C)$**

(Output,  $Z_S = Z_L = 50\Omega$ )

$V_{CE} = \text{parameter}$ ,  $f = 1.8\text{GHz}$

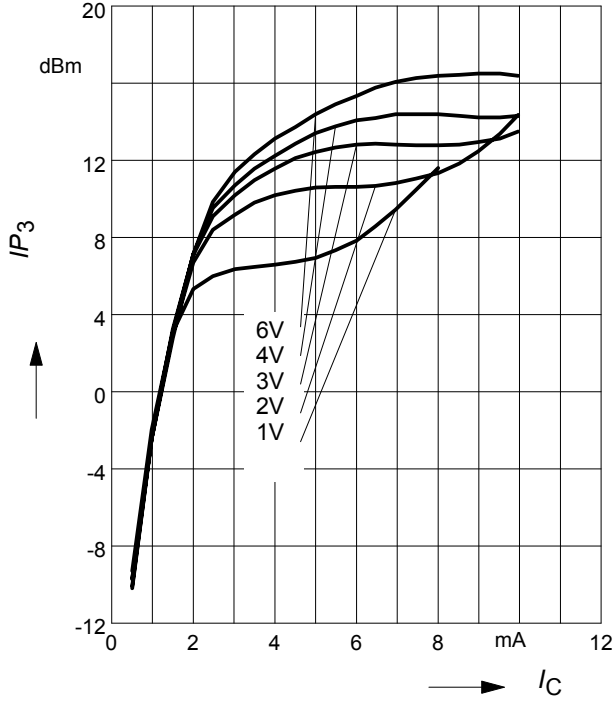

**Transition frequency  $f_T = f(I_C)$**

$f = 1\text{GHz}$

$V_{CE} = \text{parameter}$

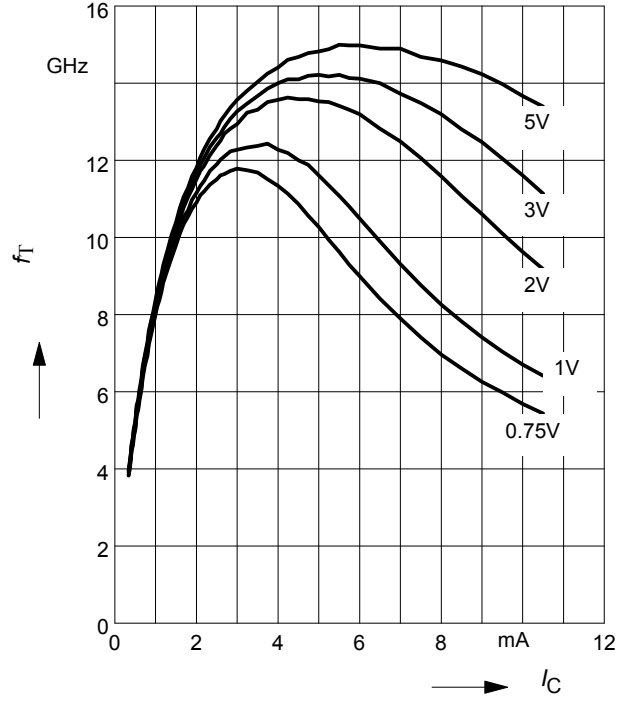

**Power gain  $G_{ma}, G_{ms} = f(I_C)$**

$f = 0.9\text{GHz}$

$V_{CE} = \text{parameter}$

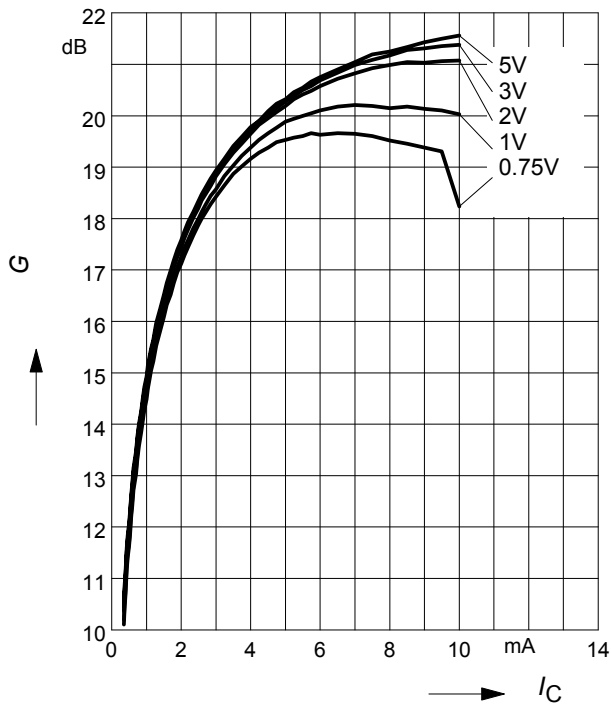

**Power gain  $G_{ma}, G_{ms} = f(I_C)$**

$f = 1.8\text{GHz}$

$V_{CE} = \text{parameter}$

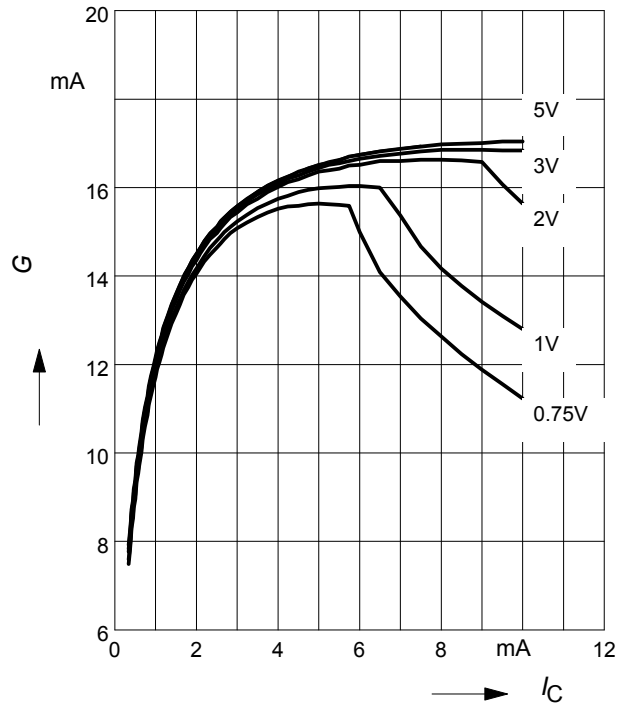

**Power Gain  $G_{ma}$ ,  $G_{ms} = f(f)$**   
 $V_{CE} = \text{parameter}$

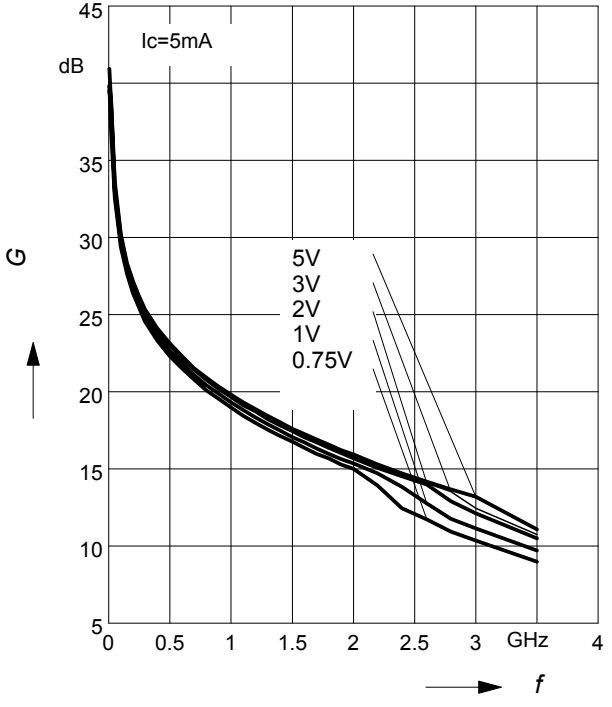

**Insertion Power Gain  $|S_{21}|^2 = f(f)$**   
 $V_{CE} = \text{parameter}$

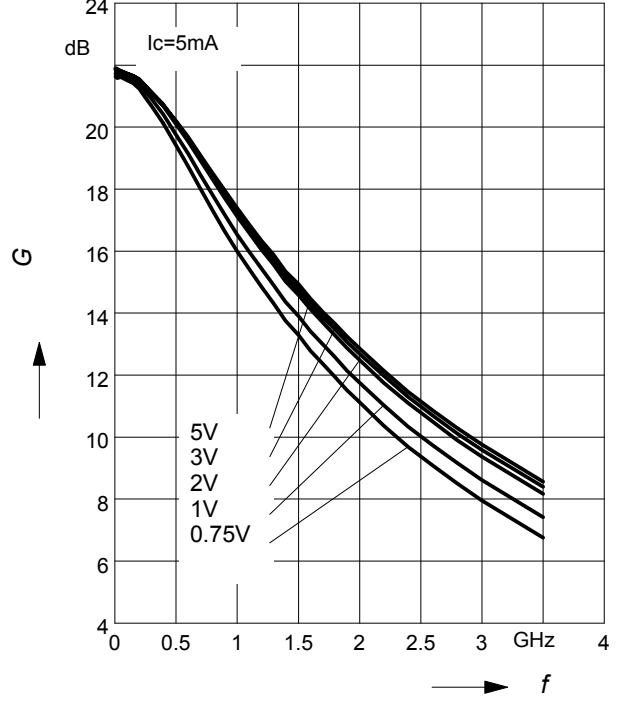

**Power Gain  $G_{ma}$ ,  $G_{ms} = f(V_{CE})$ : —**  
 $|S_{21}|^2 = f(V_{CE})$ : - - - -  
 $f = \text{parameter}$

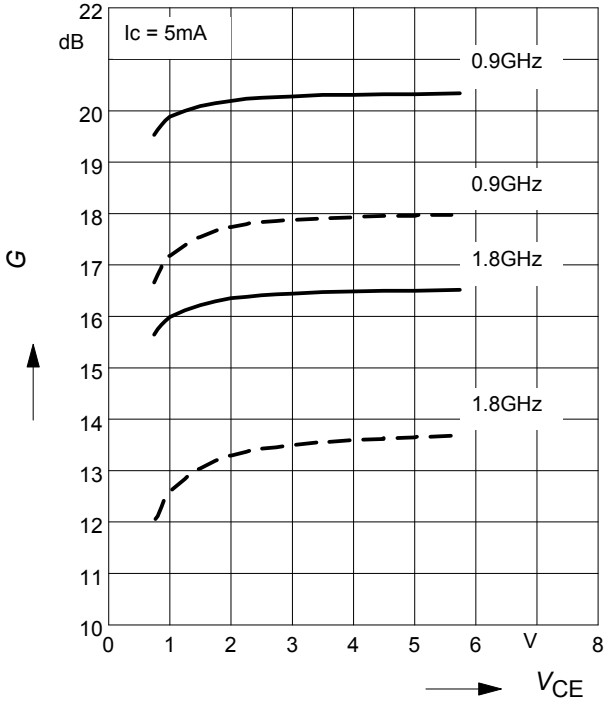

**Power gain  $G_{ma}$ ,  $G_{ms} = f(I_C)$**   
 $V_{CE} = 3V$   
 $f = \text{parameter}$

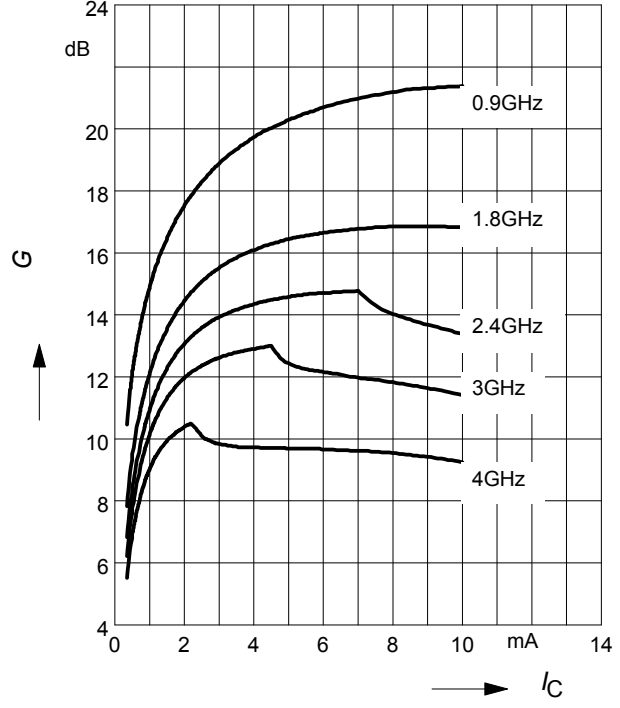

**Noise figure  $NF = f(I_C)$**

$V_{CE} = 3V, f = 1,8 \text{ GHz}$

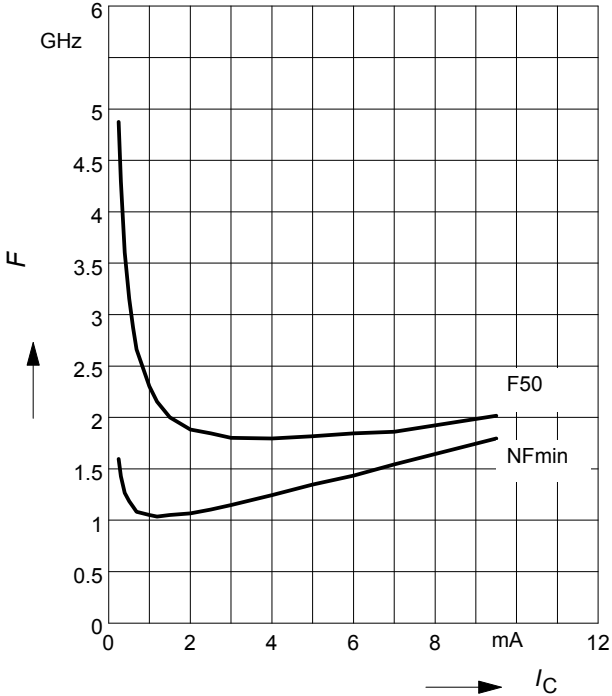

**Source impedance for min.**

**noise figure vs. frequency**

$V_{CE} = 3 \text{ V}$

