

GaAS MMIC HIGH-ISOLATION SPDT SWITCH DC - 6 GHz

FEBRUARY 2001

Features

BANDWIDTH: DC-6 GHz

HIGH ISOLATION : > 40 dB

NON-REFLECTIVE DESIGN

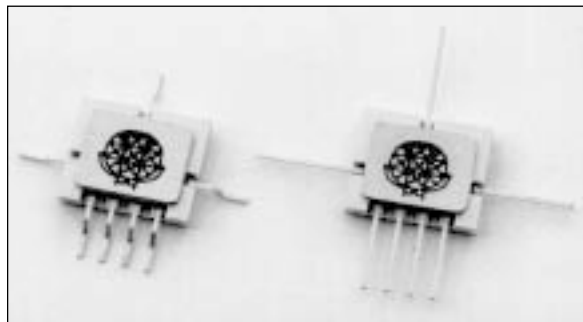

General Description

The HMC132G7 and HMC132P7 are the packaged versions of the HMC132 MMIC SPDT switch. Both use the same 7-pin ceramic package but with modified lead configurations. The G7 suffix designates package leads configured for surface mount while the P7 suffix designates package leads configured for microstrip insertion. The device is a fast, broadband SPDT switch featuring high (> 40 dB) isolation over the entire band. The switch is non-reflective at both RF1 and RF2 ports.



Guaranteed Performance, With 0/-5V control, 50 Ohm System, -55 to +85 deg C

Parameter	Frequency	Min.	Typ.	Max.	Units
Insertion Loss	DC - 3 GHz		1.5	1.9	dB
	DC - 6 GHz		2.2	2.6	dB
Isolation	DC - 3 GHz	45	50		dB
	DC - 6 GHz	35	40		dB
Return Loss	DC - 3 GHz	14	18		dB
	DC - 6 GHz	5	8		dB
Input Power for 0.1dB Compression	0.5 - 6 GHz	+20	+25		dBm
Input Power for 1dB Compression	0.5 - 6 GHz	+22	+27		dBm
Input Third Order Intercept	0.5 - 6 GHz	+38	+42		dBm
Switching Characteristics	DC - 6 GHz				
tRISE, tFALL (10/90% RF)			3		ns
tON, tOFF (50% CTL to 10/90% RF)			6		ns

HMC132G7 / HMC132P7 HIGH-ISOLATION SPDT SWITCH DC - 6 GHz

FEBRUARY 2001

Insertion Loss

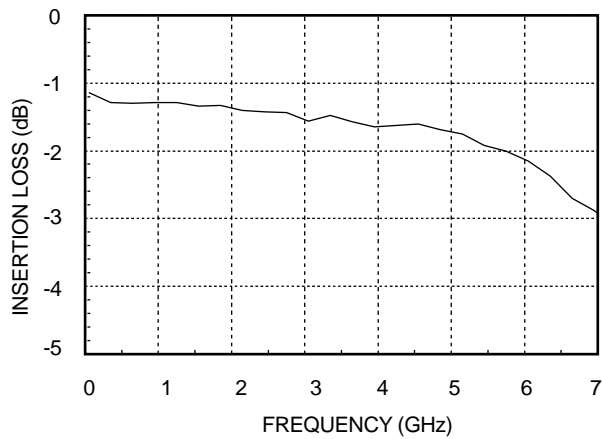

Isolation

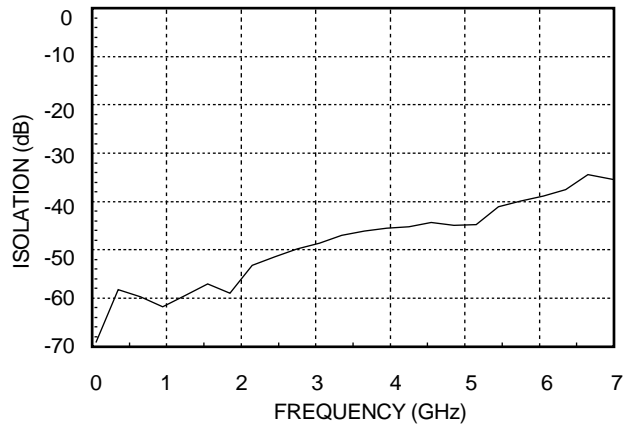

Return Loss

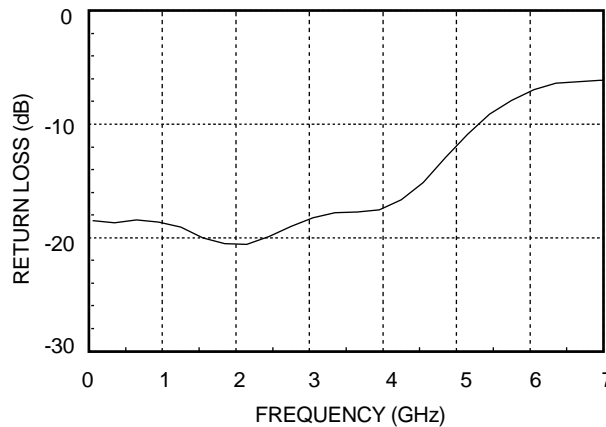

HMC132G7 / HMC132P7 HIGH-ISOLATION SPDT SWITCH DC - 6 GHZ

FEBRUARY 2001

Schematic

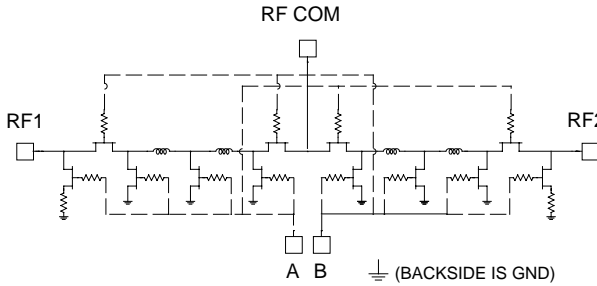

Truth Table

Control Input		Signal Path State	
A	B	RF to RF1	RF to RF2
High	Low	ON	OFF
Low	High	OFF	ON

Do not "HOT" switch power levels > +15 dBm ($V_{ctrl} = 0/-5Vdc$)

Control Voltages

State	Bias Condition
Low	0 to -0.2V @ 20uA Max.
High	-5V@200uA Typ to -7V@600uA Max

Absolute Maximum Ratings

Control Voltage Range	+0.5 to -7.5 Vdc
Storage Temperature	-65 to +150 deg C
Operating Temperature	-55 to +125 deg C

7

SMT SPDT SWITCHES

Outline: HMC132G7

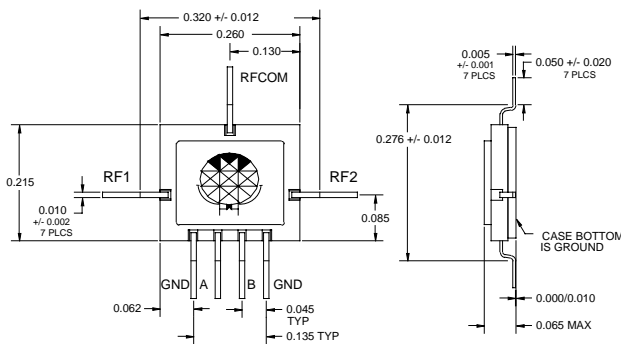

Outline: HMC132P7

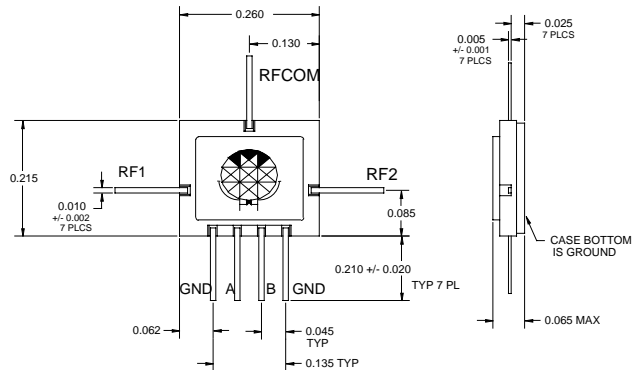

- MATERIAL:
 - PACKAGE - BODY : WHITE ALUMINA (92%)
 - LEADS - PACKAGE COVER: KOVAR (tm)
 - CONDUCTOR TRACES - THICKFILM TUNGSTEN
- PLATING (LEADS): ELECTROLYTIC GOLD 50 MICROINCHES MINIMUM OVER ELECTROLYTIC NICKEL 50 MICROINCHES MINIMUM.
- ALL UNLABELED PINS ARE GROUND.
- ALL DIMENSIONS ARE IN INCHES

HMC132G7 / HMC132P7 HIGH-ISOLATION SPDT SWITCH DC - 6 GHZ

FEBRUARY 2001

Suggested Driver Circuit for HMC132G7/P7

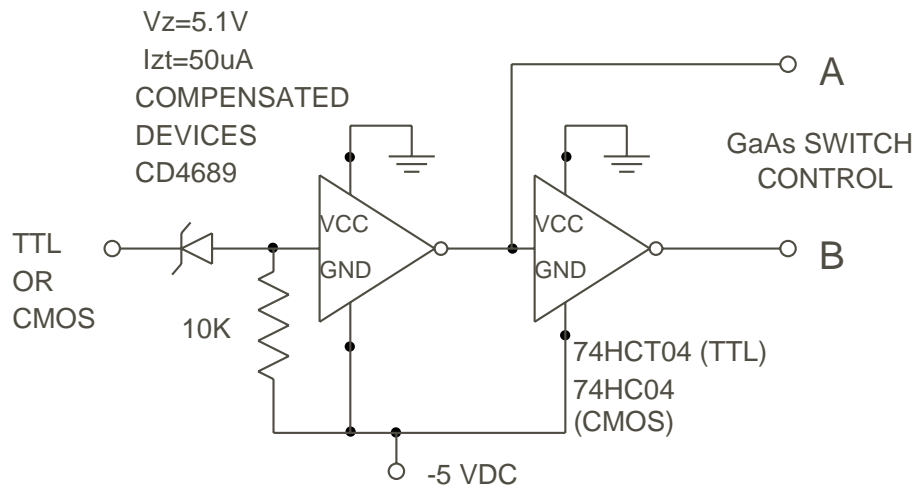

Simple driver using inexpensive standard logic ICs provides fast switching using minimum DC current.

