

- 1 - Anode 1
 2 - Common Cathode
 Back of Case - Cathode
 3 - Anode 2

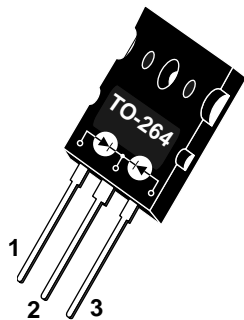

APT60D60LCT 600V 2x60A

ULTRAFAST SOFT RECOVERY RECTIFIER DIODES

PRODUCT APPLICATIONS

- Parallel Diode
 - Switchmode Power Supply
 - Inverters
- Free Wheeling Diode
 - Motor Controllers
 - Converters
- Snubber Diode
- Uninterruptible Power Supply (UPS)
- Induction Heating
- High Speed Rectifiers

PRODUCT FEATURES

- Ultrafast Recovery Times
- Soft Recovery Characteristics
- Popular TO-264 Package
- Low Forward Voltage
- High Blocking Voltage
- Low Leakage Current

PRODUCT BENEFITS

- Low Losses
- Low Noise Switching
- Cooler Operation
- Higher Reliability Systems
- Increased System Power Density

MAXIMUM RATINGS

All Ratings Are Per Leg: $T_C = 25^\circ\text{C}$ unless otherwise specified.

Symbol	Characteristic / Test Conditions	APT60D60LCT	UNIT
V_R	Maximum D.C. Reverse Voltage	600	Volts
V_{RRM}	Maximum Peak Repetitive Reverse Voltage		
V_{RWM}	Maximum Working Peak Reverse Voltage		
$I_F(AV)$	Maximum Average Forward Current ($T_C = 70^\circ\text{C}$, Duty Cycle = 0.5)	60	Amps
$I_F(RMS)$	RMS Forward Current	100	
I_{FSM}	Non-Repetitive Forward Surge Current ($T_J = 45^\circ\text{C}$, 8.3ms)	600	
T_J, T_{STG}	Operating and Storage Temperature Range	-55 to 150	$^\circ\text{C}$
T_L	Lead Temperature: 0.063" from Case for 10 Sec.	300	

STATIC ELECTRICAL CHARACTERISTICS

Symbol	Characteristic / Test Conditions	MIN	TYP	MAX	UNIT
V_F	Maximum Forward Voltage		1.75	1.8	Volts
				$I_F = 60\text{A}$	
				$I_F = 120\text{A}$	
I_{RM}	Maximum Reverse Leakage Current			250	μA
				$V_R = V_R$ Rated	
				$V_R = V_R$ Rated, $T_J = 125^\circ\text{C}$	
C_T	Junction Capacitance, $V_R = 200\text{V}$		85		pF
L_S	Series Inductance (Lead to Lead 5mm from Base)		10		nH

USA

405 S.W. Columbia Street

EUROPE

Avenue J.F. Kennedy Bât B4 Parc Cadéra Nord

APT Website - <http://www.advancedpower.com>

Bend, Oregon 97702-1035

Phone: (541) 382-8028

FAX: (541) 388-0364

F-33700 Merignac - France

Phone: (33) 5 57 92 15 15

FAX: (33) 5 56 47 97 61

DYNAMIC CHARACTERISTICS

APT60D60LCT

Symbol	Characteristic	MIN	TYP	MAX	UNIT
t_{rr1}	Reverse Recovery Time, $I_F = 1.0A$, $di_F/dt = -15A/\mu s$, $V_R = 30V$, $T_J = 25^\circ C$		55	70	ns
t_{rr2}	Reverse Recovery Time		70		
t_{rr3}	$I_F = 60A$, $di_F/dt = -480A/\mu s$, $V_R = 350V$		90		
t_{fr1}	Forward Recovery Time		160		
t_{fr2}	$I_F = 60A$, $di_F/dt = 480A/\mu s$, $V_R = 350V$		160		
I_{RRM1}	Reverse Recovery Current		10	17	Amps
I_{RRM2}	$I_F = 60A$, $di_F/dt = -480A/\mu s$, $V_R = 350V$		20	30	
Q_{rr1}	Recovery Charge		350		nC
Q_{rr2}	$I_F = 60A$, $di_F/dt = -480A/\mu s$, $V_R = 350V$		900		
V_{fr1}	Forward Recovery Voltage		6		Volts
V_{fr2}	$I_F = 60A$, $di_F/dt = 480A/\mu s$, $V_R = 350V$		6		
di_M/dt	Rate of Fall of Recovery Current		800		A/ μs
	$I_F = 60A$, $di_F/dt = -480A/\mu s$, $V_R = 350V$ (See Figure 10)		500		

THERMAL AND MECHANICAL CHARACTERISTICS

Symbol	Characteristic / Test Conditions	MIN	TYP	MAX	UNIT
$R_{\theta JC}$	Junction-to-Case Thermal Resistance			0.66	$^\circ C/W$
$R_{\theta JA}$	Junction-to-Ambient Thermal Resistance			40	
W_T	Package Weight		0.22		oz
			6.1		gm
Torque	Maximum Mounting Torque (Screw Type = 6-32 or 3mm Machine)			10	lb•in
				1.1	N•m

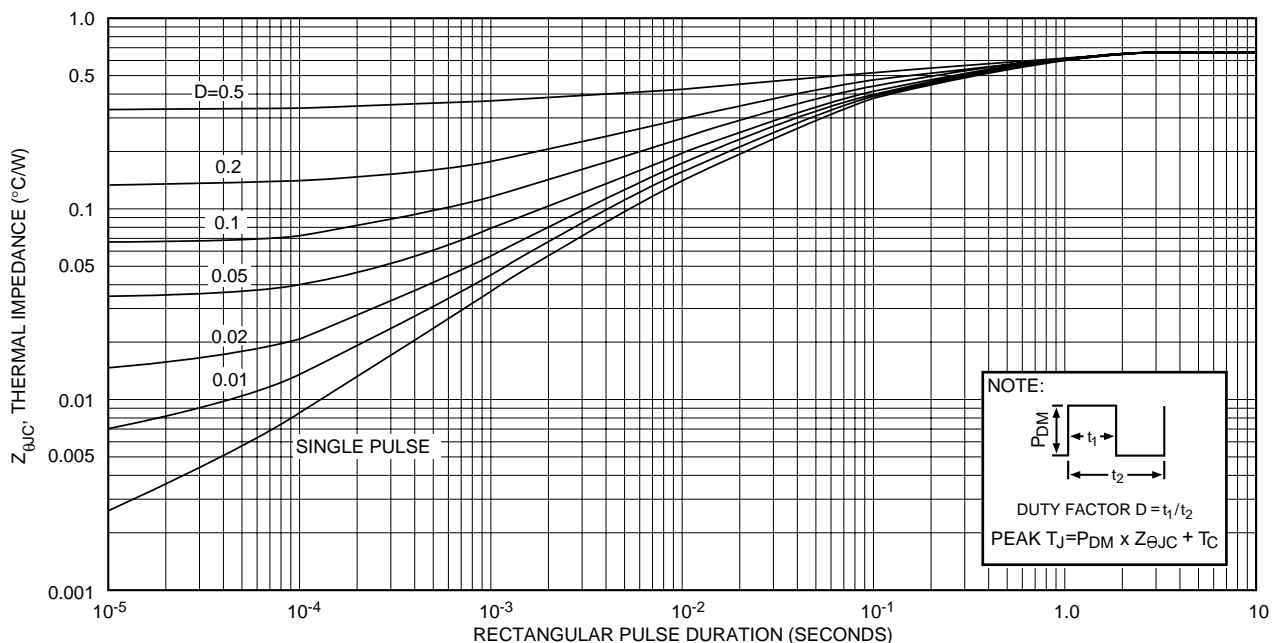

FIGURE 1, MAXIMUM EFFECTIVE TRANSIENT THERMAL IMPEDANCE, JUNCTION-TO-CASE vs PULSE DURATION

APT60D60LCT

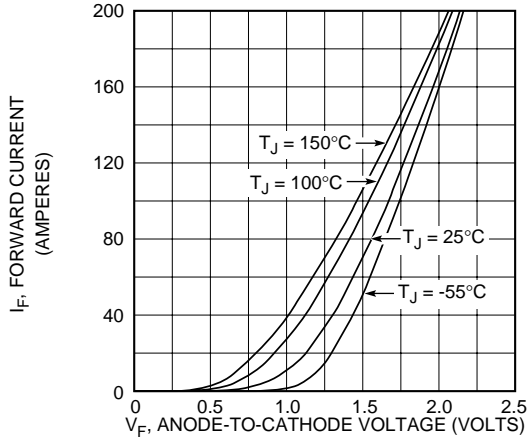

Figure 2, Forward Voltage Drop vs Forward Current

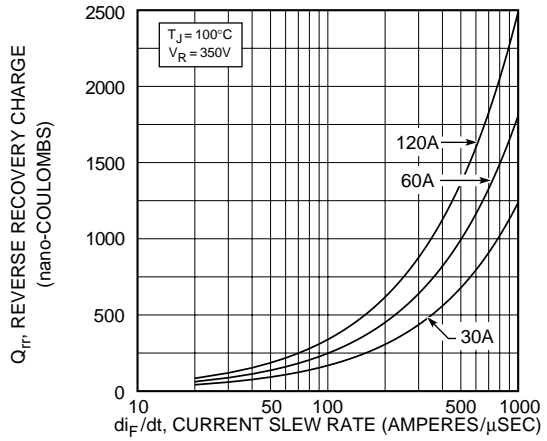

Figure 3, Reverse Recovery Charge vs Current Slew Rate

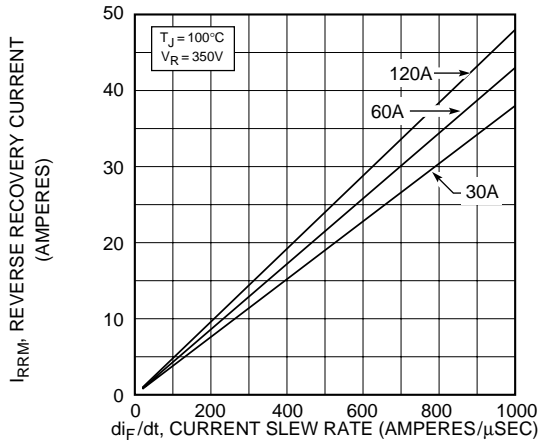

Figure 4, Reverse Recovery Current vs Current Slew Rate

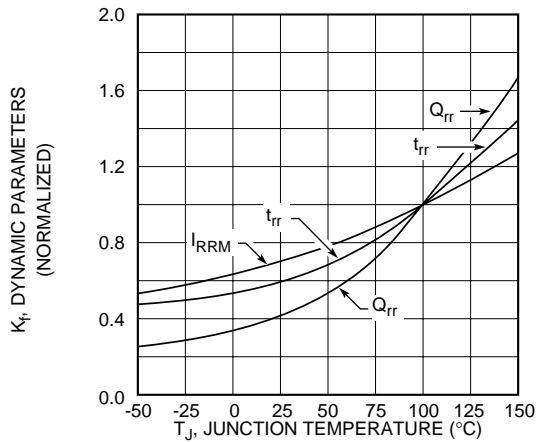

Figure 5, Dynamic Parameters vs Junction Temperature

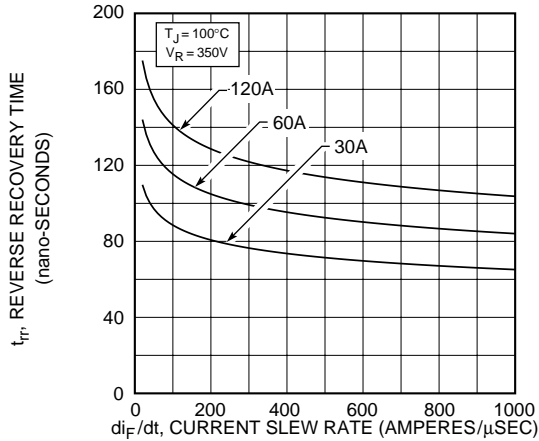

Figure 6, Reverse Recovery Time vs Current Slew Rate

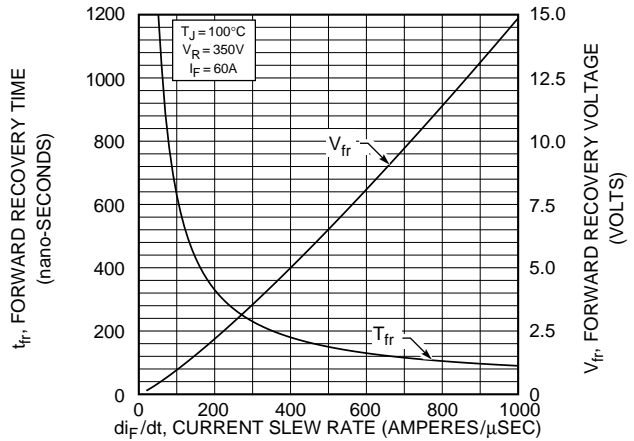

Figure 7, Forward Recovery Voltage/Time vs Current Slew Rate

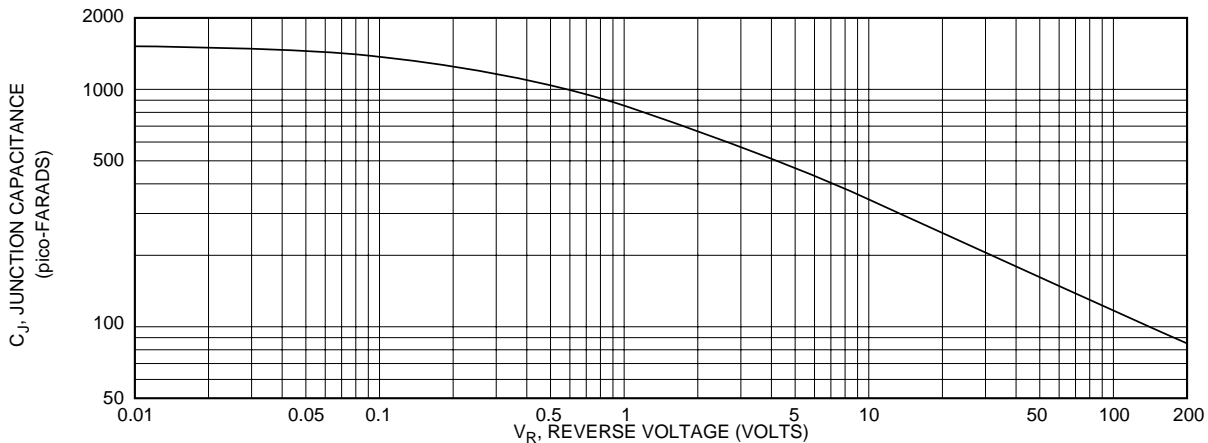

Figure 8, Junction Capacitance vs Reverse Voltage

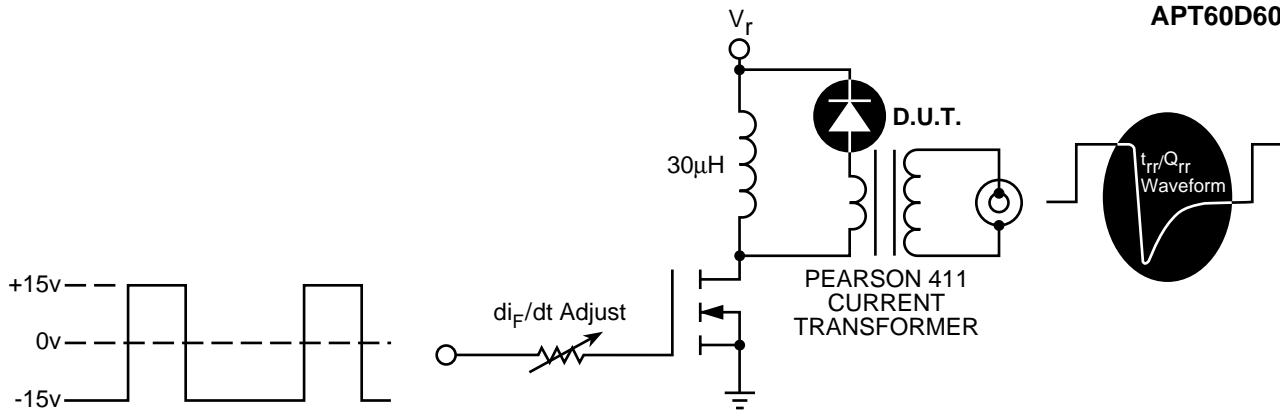

Figure 9, Diode Reverse Recovery Test Circuit and Waveforms

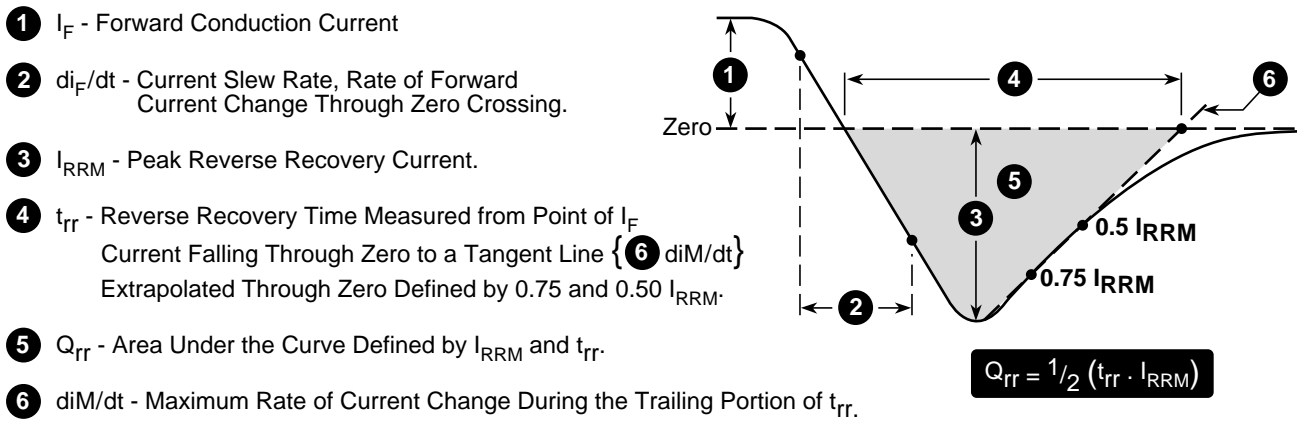
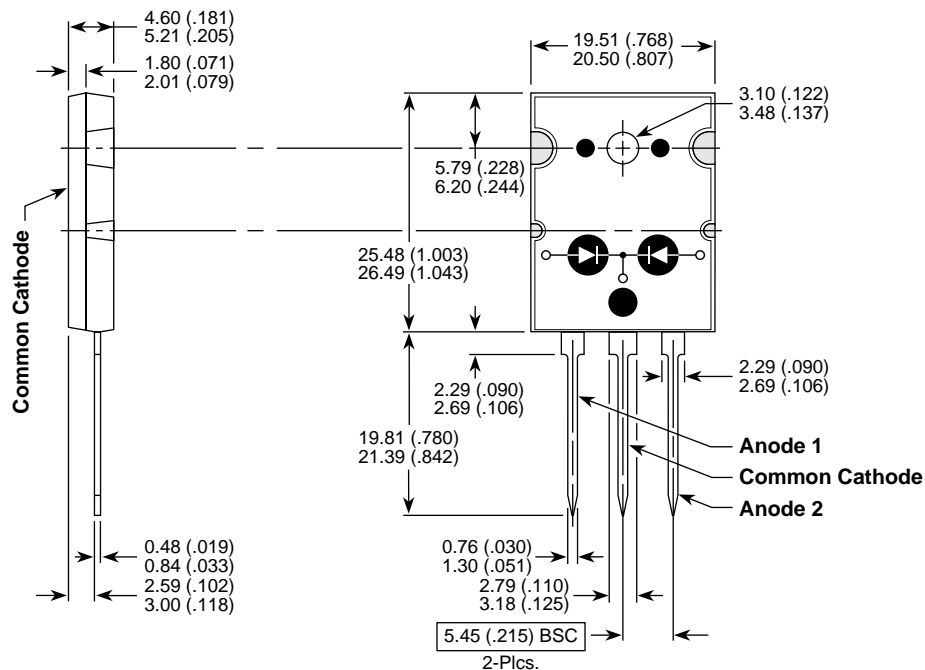

Figure 10, Diode Reverse Recovery Waveform and Definitions

TO-264 Package Outline



Dimensions in Millimeters and (Inches)