

2N5638, 2N5639

2N5638 is a Preferred Device

JFET Chopper Transistors

N-Channel – Depletion

N-Channel Junction Field Effect Transistors, depletion mode (Type A) designed for chopper and high-speed switching applications.

- Low Drain-Source “ON” Resistance:
 - $R_{DS(on)} = 30\Omega$ for 2N5638
 - $R_{DS(on)} = 60\Omega$ for 2N5639
- Low Reverse Transfer Capacitance
 - $C_{RSS} = 4.0 \text{ pF (Max) @ } f = 1.0 \text{ MHz}$
- Fast Switching Characteristics
 - $t_r = 5.0 \text{ ns (Max) (2N5638)}$



ON Semiconductor™

<http://onsemi.com>

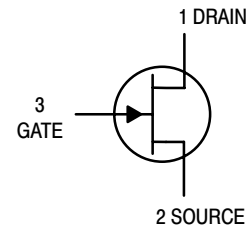

MAXIMUM RATINGS

Rating	Symbol	Value	Unit
Drain-Source Voltage	V_{DS}	30	Vdc
Drain-Gate Voltage	V_{DG}	30	Vdc
Reverse Gate-Source Voltage	V_{GSR}	30	Vdc
Forward Gate Current	I_{GF}	10	mAdc
Total Device Dissipation @ $T_A = 25^\circ\text{C}$ Derate above 25°C	P_D	310 2.82	mW mW/ $^\circ\text{C}$
Storage Temperature Range	T_{stg}	-65 to +150	$^\circ\text{C}$
Operating Junction Temp Range	T_J	-65 to +135	$^\circ\text{C}$

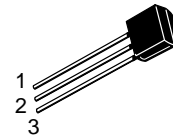

**TO-92
CASE 29
STYLE 5**

MARKING DIAGRAMS

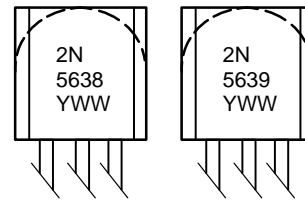

Y = Year
WW = Work Week

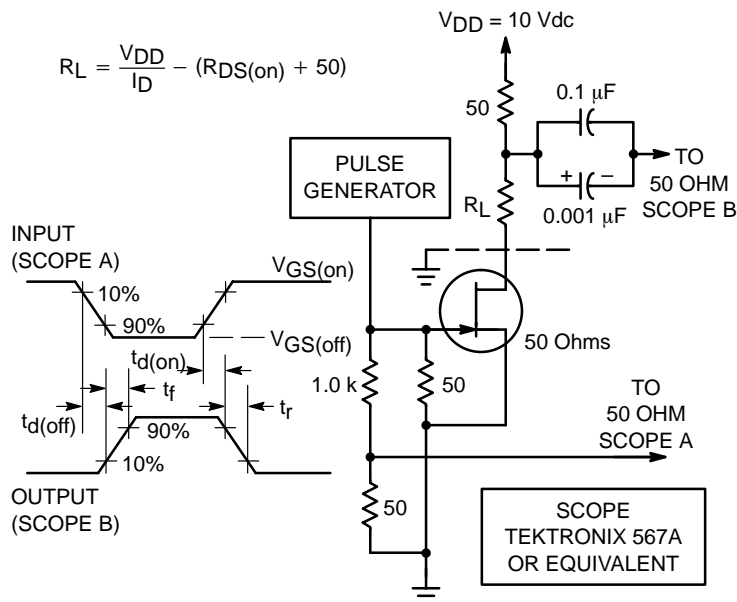

Figure 1. Switching Times Test Circuit

ORDERING INFORMATION

Device	Package	Shipping
2N5638RLRA	TO-92	2000/Tape & Reel
2N5639	TO-92	5000/Box
2N5369RLRA	TO-92	2000/Tape & Reel

Preferred devices are recommended choices for future use and best overall value.

2N5638, 2N5639

ELECTRICAL CHARACTERISTICS (T_A = 25°C unless otherwise noted)

Characteristic	Symbol	Min	Max	Unit
----------------	--------	-----	-----	------

OFF CHARACTERISTICS

Gate–Source Breakdown Voltage (I _G = -1.0 μAdc, V _{DS} = 0)	V _{(BR)GSS}	35	–	Vdc
Gate Reverse Current (V _{GS} = -15 Vdc, V _{DS} = 0) (V _{GS} = -15 Vdc, V _{DS} = 0, T _A = 100°C)	I _{GSS}	–	1.0 1.0	nAdc μAdc
Drain–Cutoff Current (V _{DS} = 15 Vdc, V _{GS} = -12 Vdc) (V _{DS} = 15 Vdc, V _{GS} = -12 Vdc, T _A = 100°C) (V _{DS} = 15 Vdc, V _{GS} = -8.0 Vdc) (V _{DS} = 15 Vdc, V _{GS} = -8.0 Vdc, T _A = 100°C)	I _{D(off)}	–	1.0 1.0 1.0 1.0	μAdc

ON CHARACTERISTICS

Zero–Gate–Voltage Drain Current (Note 1.) (V _{DS} = 20 Vdc, V _{GS} = 0)	2N5638 2N5639	I _{DSS}	50 25	– –	mAdc
Drain–Source “ON” Voltage (I _D = 12 mAdc, V _{GS} = 0) (I _D = 6.0 mAdc, V _{GS} = 0)	2N5638 2N5639	V _{DS(on)}	– –	0.5 0.5	Vdc
Static Drain–Source “ON” Resistance (I _D = 1.0 mAdc, V _{GS} = 0)	2N5638 2N5639	R _{DS(on)}	– –	30 60	Ω

SMALL–SIGNAL CHARACTERISTICS

Static Drain–Source “ON” Resistance (V _{GS} = 0, I _D = 0, f = 1.0 kHz)	2N5638 2N5639	R _{DS(on)}	– –	30 60	Ω
Input Capacitance (V _{DS} = 0, V _{GS} = -12 Vdc, f = 1.0 MHz)		C _{iss}	–	10	pF
Reverse Transfer Capacitance (V _{DS} = 0, V _{GS} = -12 Vdc, f = 1.0 MHz)		C _{rss}	–	4.0	pF

SWITCHING CHARACTERISTICS (V_{DD} = 10 Vdc, V_{GS(on)} = 0, V_{GS(off)} = -10 Vdc, R_{G'} = 50 Ω. See Figure 1 on page 1)

Turn–On Delay Time I _{D(on)} = 12 mAdc, 2N5638 I _{D(on)} = 6.0 mAdc, 2N5639		t _{d(on)}	– –	4.0 6.0	ns
Rise Time I _{D(on)} = 12 mAdc, 2N5638 I _{D(on)} = 6.0 mAdc, 2N5639		t _r	– –	5.0 8.0	ns
Turn–Off Delay Time I _{D(on)} = 12 mAdc, 2N5638 I _{D(on)} = 6.0 mAdc, 2N5639		t _{d(off)}	– –	5.0 10	ns
Fall Time I _{D(on)} = 12 mAdc, 2N5638 I _{D(on)} = 6.0 mAdc, 2N5639		t _f	– –	10 20	ns

1. Pulse Width ≤ 300 μs, Duty Cycle ≤ 3.0%.

2N5638, 2N5639

PACKAGE DIMENSIONS

TO-92 (TO-226)
CASE 29-11
ISSUE AL

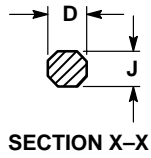
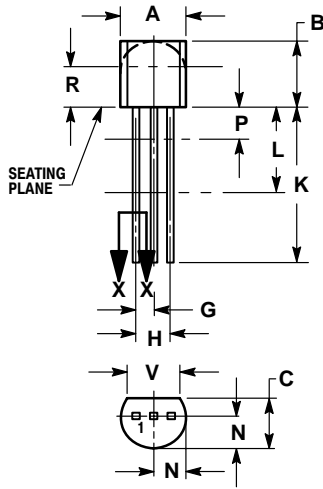

NOTES:

1. DIMENSIONING AND TOLERANCING PER ANSI Y14.5M, 1982.
2. CONTROLLING DIMENSION: INCH.
3. CONTOUR OF PACKAGE BEYOND DIMENSION R IS UNCONTROLLED.
4. LEAD DIMENSION IS UNCONTROLLED IN P AND BEYOND DIMENSION K MINIMUM.

DIM	INCHES		MILLIMETERS	
	MIN	MAX	MIN	MAX
A	0.175	0.205	4.45	5.20
B	0.170	0.210	4.32	5.33
C	0.125	0.165	3.18	4.19
D	0.016	0.021	0.407	0.533
G	0.045	0.055	1.15	1.39
H	0.095	0.105	2.42	2.66
J	0.015	0.020	0.39	0.50
K	0.500	---	12.70	---
L	0.250	---	6.35	---
N	0.080	0.105	2.04	2.66
P	---	0.100	---	2.54
R	0.115	---	2.93	---
V	0.135	---	3.43	---

ON Semiconductor and  are trademarks of Semiconductor Components Industries, LLC (SCILLC). SCILLC reserves the right to make changes without further notice to any products herein. SCILLC makes no warranty, representation or guarantee regarding the suitability of its products for any particular purpose, nor does SCILLC assume any liability arising out of the application or use of any product or circuit, and specifically disclaims any and all liability, including without limitation special, consequential or incidental damages. "Typical" parameters which may be provided in SCILLC data sheets and/or specifications can and do vary in different applications and actual performance may vary over time. All operating parameters, including "Typicals" must be validated for each customer application by customer's technical experts. SCILLC does not convey any license under its patent rights nor the rights of others. SCILLC products are not designed, intended, or authorized for use as components in systems intended for surgical implant into the body, or other applications intended to support or sustain life, or for any other application in which the failure of the SCILLC product could create a situation where personal injury or death may occur. Should Buyer purchase or use SCILLC products for any such unintended or unauthorized application, Buyer shall indemnify and hold SCILLC and its officers, employees, subsidiaries, affiliates, and distributors harmless against all claims, costs, damages, and expenses, and reasonable attorney fees arising out of, directly or indirectly, any claim of personal injury or death associated with such unintended or unauthorized use, even if such claim alleges that SCILLC was negligent regarding the design or manufacture of the part. SCILLC is an Equal Opportunity/Affirmative Action Employer.

PUBLICATION ORDERING INFORMATION

Literature Fulfillment:

Literature Distribution Center for ON Semiconductor
P.O. Box 5163, Denver, Colorado 80217 USA
Phone: 303-675-2175 or 800-344-3860 Toll Free USA/Canada
Fax: 303-675-2176 or 800-344-3867 Toll Free USA/Canada
Email: ONlit@hibbertco.com

N. American Technical Support: 800-282-9855 Toll Free USA/Canada

JAPAN: ON Semiconductor, Japan Customer Focus Center
4-32-1 Nishi-Gotanda, Shinagawa-ku, Tokyo, Japan 141-0031
Phone: 81-3-5740-2700
Email: r14525@onsemi.com

ON Semiconductor Website: <http://onsemi.com>

For additional information, please contact your local Sales Representative.