

BIPOLAR ANALOG INTEGRATED CIRCUITS

 μ PC1241H, μ PC1242H

T-74-05-01

7 W AF POWER AMPLIFIER

DESCRIPTION

The μ PC1241H and μ PC1242H are audio power amplifiers which is especially designed for car radio and car stereo.

The devices are encapsulated in newly developed small packages featuring low thermal resistance, providing easy design for 2 Ω load circuit.

At 14.4 V the devices give output power of 7 W at $R_L = 4 \Omega$ and 11 W at $R_L = 2 \Omega$

FEATURES

- High output power : $P_O = 7 \text{ W TYP.}$ @ $R_L = 4 \Omega$, T.H.D. = 10 %, $V_{CC} = 14.4 \text{ V}$
 $P_O = 11 \text{ W TYP.}$ @ $R_L = 2 \Omega$, T.H.D. = 10 %, $V_{CC} = 14.4 \text{ V}$
- Low distortion : T.H.D. = 0.1 % TYP. @ $R_L = 4 \Omega$, $P_O = 0.5 \text{ W}$
- High reliability : of the chip and package with additional complete safety during operation thanks to protection against:
 - (1) Load dump voltage surge.
 - (2) Over rating chip temperature (150 °C).
 - (3) Output DC and AC short circuit to ground or V_{CC} .
 - (4) Reverse insertion.

These ICs are not destroyed nor damaged even when any of neighboring two terminals are shorted to each other.

- Space and cost saving: very low number of external components, very simple mounting system with no electrical isolation between the package and the heat sink (one screw only).
- Pin orders of these types are symmetrical each other, which reduces the area of Printed Circuit Board effectively.

PACKAGE DIMENSIONS (Unit : mm)

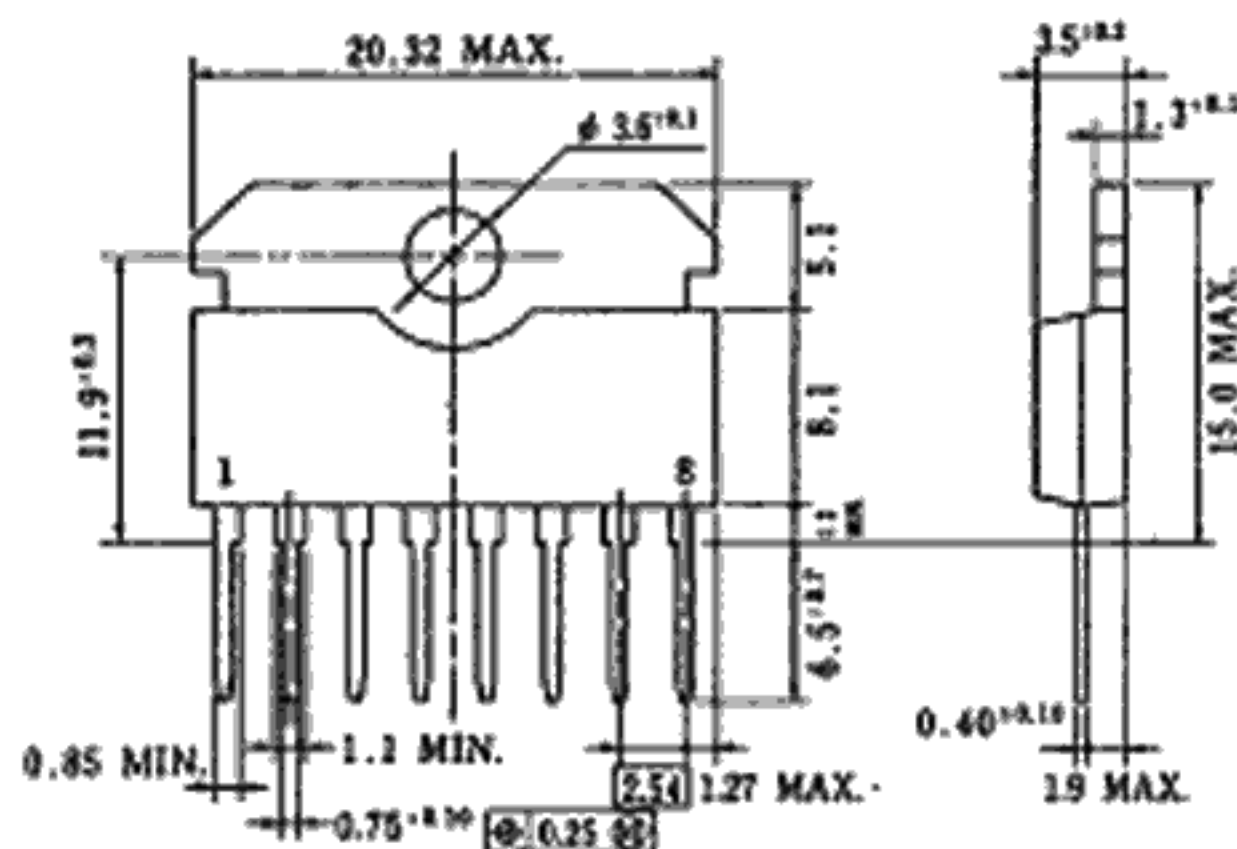

P80P-1502

BLOCK DIAGRAM

T-74-05-01

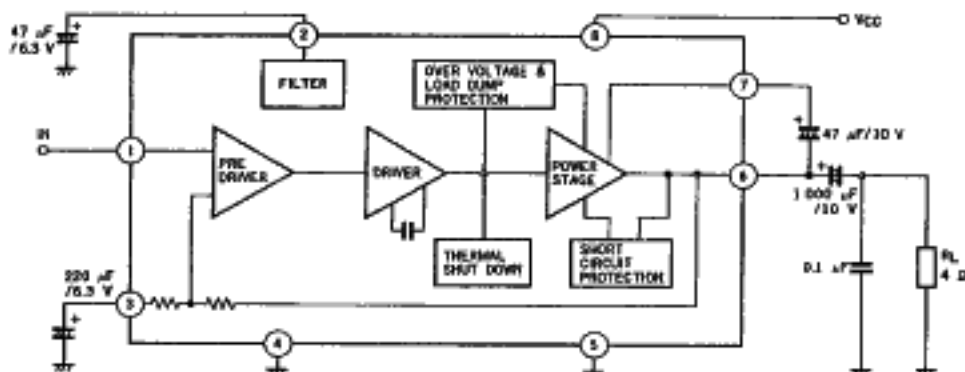

CONNECTION DIAGRAM

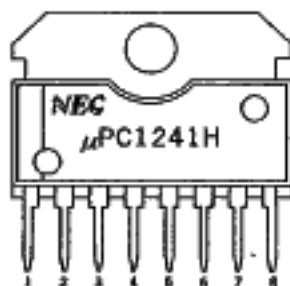
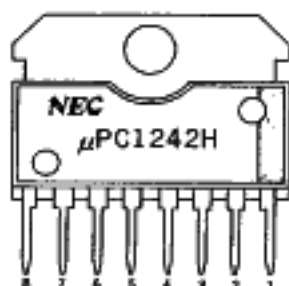
 μ PC1241H μ PC1242H

Pin No.	μ PC1241H μ PC1242H
1	Input
2	Bypass
3	Feedback
4	GND (for Input)
5	GND (for Output)
6	Output
7	Bootstrap
8	Power supply

T-74-05-01

ABSOLUTE MAXIMUM RATINGS ($T_a = 25^\circ\text{C}$)

Supply Voltage (Surge PW=200 ns)	$V_{CC \text{ surge}}$	60	V
Supply Voltage (Operational)	V_{CC}	18*	V
Circuit Current (Peak)	$I_{CC \text{ peak}}$	4.5	A
Package Dissipation	P_D	12	W
Operating Temperature	T_{opt}	-30 to +75*	$^\circ\text{C}$
Storage Temperature	T_{stg}	-55 to +150	$^\circ\text{C}$

*Using an aluminum heat sink 100 X 100 X 1 mm

RECOMMENDED CONDITIONS ($T_a = 25^\circ\text{C}$)

Supply Voltage Range	9.5 to 18	V
Load Impedance	2 to 16	Ω

ELECTRICAL CHARACTERISTICS ($T_a = 25^\circ\text{C}$, $f = 1 \text{ kHz}$, $R_L = 4 \Omega$)

CHARACTERISTIC	SYMBOL	MIN.	TYP.	MAX.	UNIT	TEST CONDITION
Over Voltage Protection	$V_{CC(MAX.)}$	18	19		V	
Circuit Current	I_{CC}	25	45	80	mA	$V_{in} = 0$, $V_{CC} = 13.2 \text{ V}$
Output Power	P_O	6.0	5.8		W	$R_L = 4 \Omega$, T.H.D. = 10%, $V_{CC} = 13.2 \text{ V}$
			7		W	$R_L = 4 \Omega$, T.H.D. = 10%, $V_{CC} = 14.4 \text{ V}$
			9.2		W	$R_L = 2 \Omega$, T.H.D. = 10%, $V_{CC} = 13.2 \text{ V}$
			11		W	$R_L = 2 \Omega$, T.H.D. = 10%, $V_{CC} = 14.4 \text{ V}$
Total Harmonic Distortion	T.H.D.		0.1	1	%	$R_L = 4 \Omega$, $P_O = 0.5 \text{ W}$, $V_{CC} = 13.2 \text{ V}$
			0.4		%	$R_L = 2 \Omega$, $P_O = 1 \text{ W}$, $V_{CC} = 13.2 \text{ V}$
Voltage Gain	A_V	49	61.5	54	dB	$P_O = 0.5 \text{ W}$
Output Noise Level	V_n		1.4	4.0	mV	$R_O = 10 \text{ k}\Omega$

TEST CIRCUIT

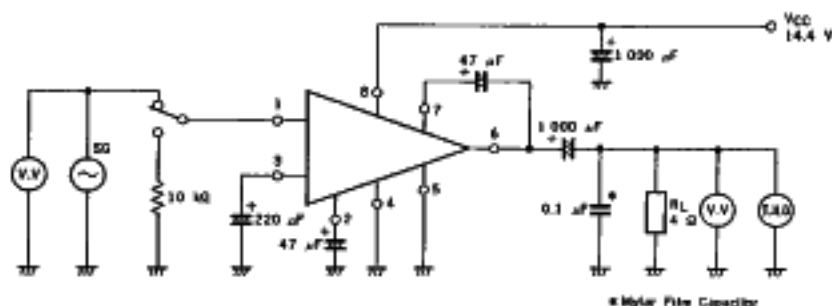

TYPICAL CHARACTERISTICS ($T_a = 25^\circ\text{C}$)

T-74-05-01

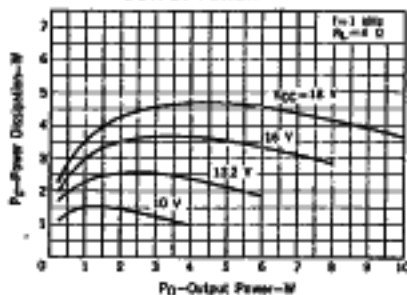
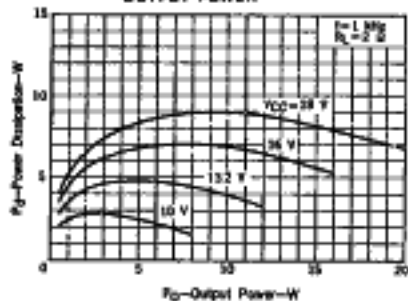
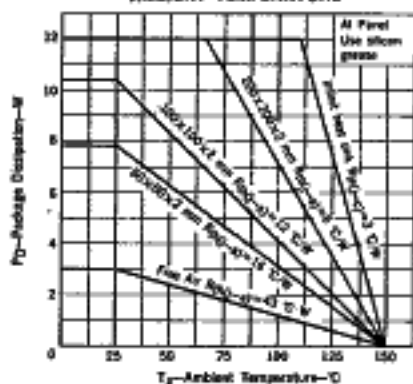
POWER DISSIPATION vs.
OUTPUT POWERPOWER DISSIPATION vs.
OUTPUT POWERPACKAGE DISSIPATION vs.
AMBIENT TEMPERATURE

VOLTAGE GAIN vs. FREQUENCY

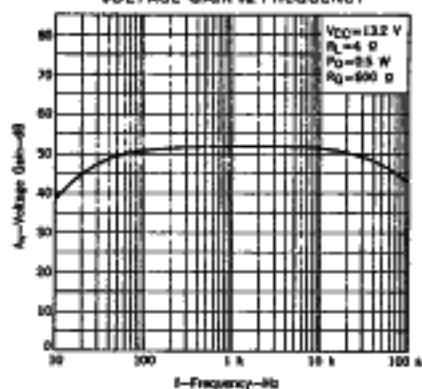
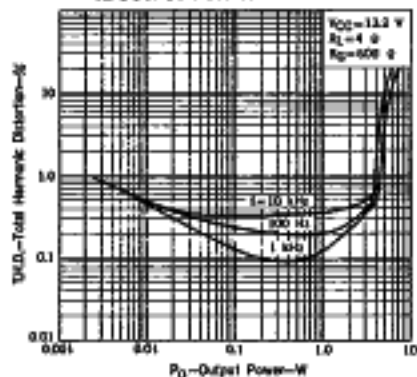
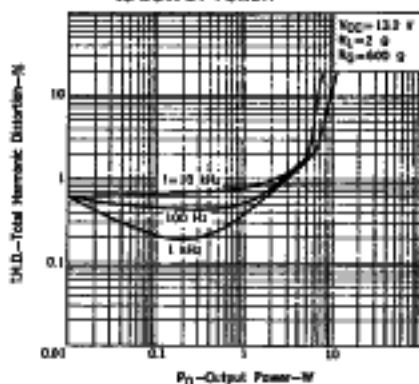
TOTAL HARMONIC DISTORTION
vs. OUTPUT POWERTOTAL HARMONIC DISTORTION
vs. OUTPUT POWER

TOTAL HARMONIC DISTORTION
vs. FREQUENCY

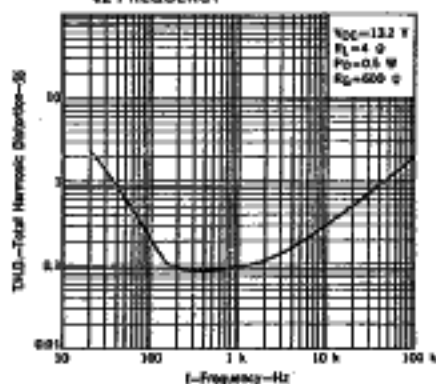

TOTAL HARMONIC DISTORTION
vs. SIGNAL SOURCE RESISTANCE

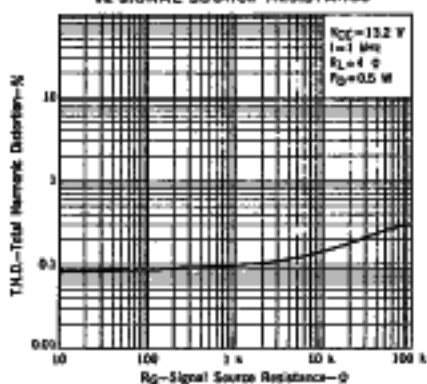

OUTPUT NOISE VOLTAGE vs.
SIGNAL SOURCE RESISTANCE

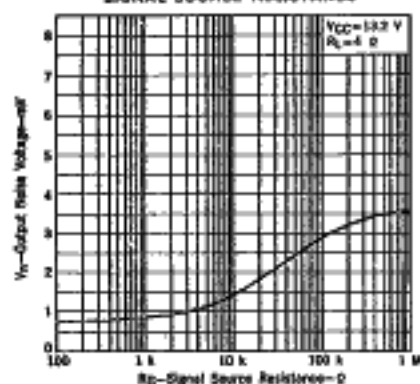

SUPPLY VOLTAGE REJECTION
vs. RIPPLE FREQUENCY

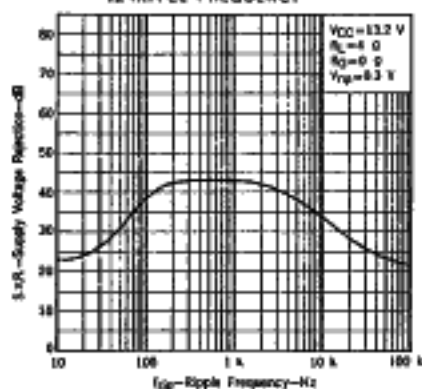

OUTPUT POWER vs.
SUPPLY VOLTAGE

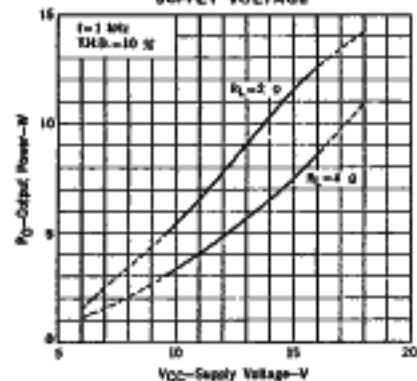

SUPPLY VOLTAGE CHARACTERISTICS

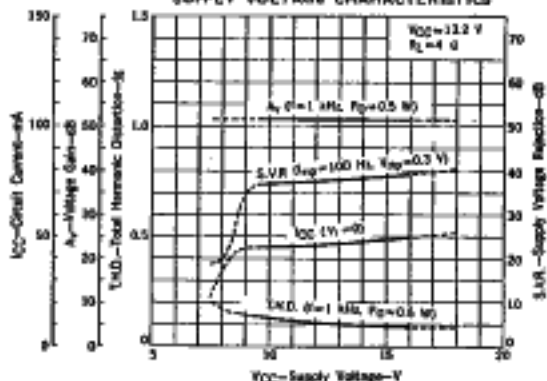

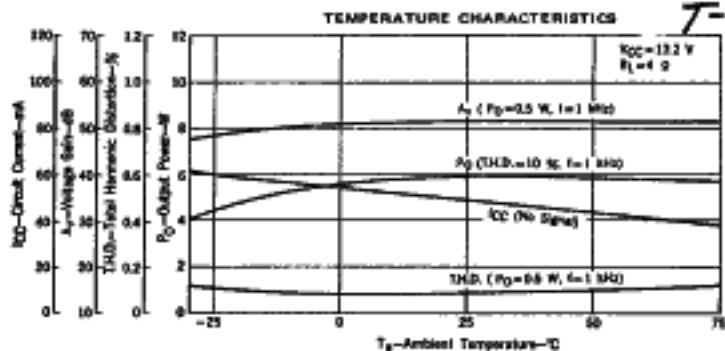

TYPICAL APPLICATIONS

(1) Circuit Example 1

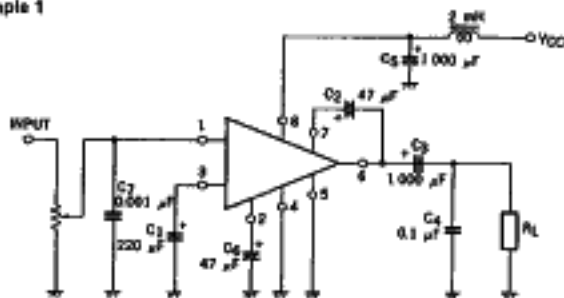

Fig. A

(2) Circuit Example 2

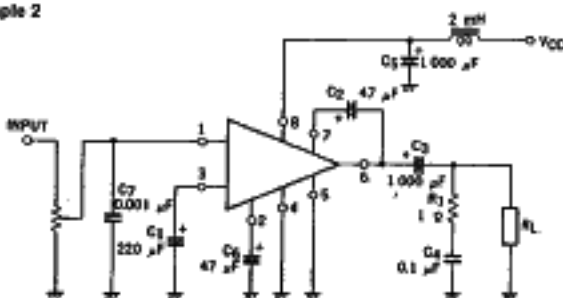
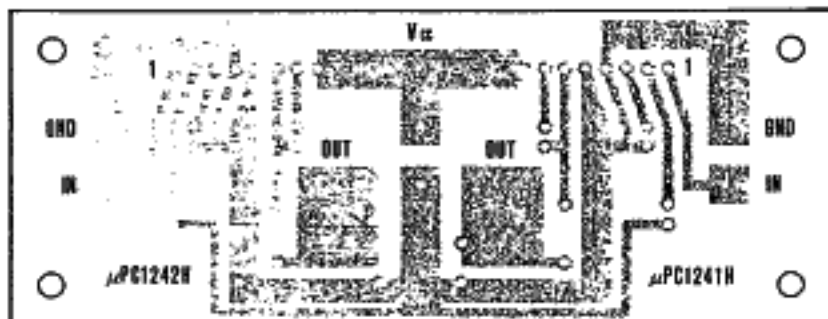
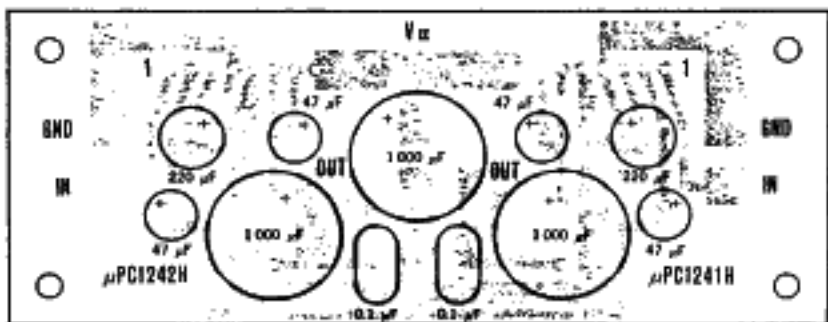

Fig. B

- The capacitor C_4 is for preventing a parasitic oscillation. A mylar film capacitor is recommended. If an oscillation occur, increase capacitance of C_4 , or connect an additional resistor R_1 as shown in Fig. B.



COMPONENTS LAYOUT FOR P.C. ASSEMBLY (Copper side)



INSTRUCTION FOR USE

- How to attach to the heat sink.
 - Surely use the silicon grease.
 - Keep fastening torque for the screw in the range of 5 to 8 kg-m.
- Use TAB as floating or connect to output GND (pin #5).
Do not use TAB for power supply GND.
- When this IC is unstable due to the high impedance of signal source, connect the capacitance C_y (around 0.001 μ F) between input (pin #1) and input GND (pin #4).