



SD57030-01

RF POWER TRANSISTORS The *LdmoST* FAMILY

PRELIMINARY DATA

N-CHANNEL ENHANCEMENT-MODE LATERAL MOSFETs

- EXCELLENT THERMAL STABILITY
- COMMON SOURCE CONFIGURATION
- $P_{OUT} = 30\text{ W}$ with 13 dB gain @ 945 MHz
- BeO FREE PACKAGE

DESCRIPTION

The SD57030-01 is a common source N-Channel enhancement-mode lateral Field-Effect RF power transistor designed for broadband commercial and industrial applications at frequencies up to 1.0 GHz. The SD57030-01 is designed for high gain and broadband performance operating in common source mode at 28V. It is ideal for base stations applications requiring high linearity.

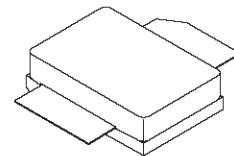

M250

epoxy sealed

ORDER CODE

SD57030-01

BRANDING

XSD57030-01

PIN CONNECTION

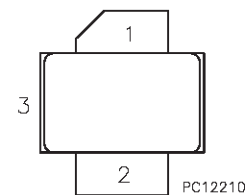

1. Drain 3. Source
2. Gate

ABSOLUTE MAXIMUM RATINGS ($T_{case} = 25\text{ }^{\circ}\text{C}$)

Symbol	Parameter	Value	Unit
$V_{(BR)DSS}$	Drain Source Voltage	65	V
V_{GS}	Gate-Source Voltage	± 20	V
I_D	Drain Current	4	A
P_{DISS}	Power Dissipation (@ $T_c = 70^{\circ}\text{C}$)	74	W
T_j	Max. Operating Junction Temperature	200	$^{\circ}\text{C}$
T_{STG}	Storage Temperature	-65 to 150	$^{\circ}\text{C}$

THERMAL DATA

$R_{th(j-c)}$	Junction-Case Thermal Resistance	1.75	$^{\circ}\text{C/W}$
---------------	----------------------------------	------	----------------------

ELECTRICAL SPECIFICATION ($T_{\text{case}} = 25\text{ }^{\circ}\text{C}$)

STATIC

Symbol	Parameter			Min.	Typ.	Max.	Unit
$V_{(\text{BR})\text{DSS}}$	$V_{\text{GS}} = 0\text{V}$	$I_{\text{DS}} = 10\text{ mA}$		65			V
I_{DSS}	$V_{\text{GS}} = 0\text{V}$	$V_{\text{DS}} = 28\text{ V}$				1	μA
I_{GSS}	$V_{\text{GS}} = 20\text{V}$	$V_{\text{DS}} = 0\text{ V}$				1	μA
$V_{\text{GS(Q)}}$	$V_{\text{DS}} = 28\text{V}$	$I_{\text{D}} = 50\text{ mA}$		2.0		5.0	V
$V_{\text{DS(ON)}}$	$V_{\text{GS}} = 10\text{V}$	$I_{\text{D}} = 3\text{ A}$			1.3		V
g_{FS}	$V_{\text{DS}} = 10\text{V}$	$I_{\text{D}} = 3\text{ A}$			1.8		mho
C_{ISS}	$V_{\text{GS}} = 0\text{V}$	$V_{\text{DS}} = 28\text{ V}$	$f = 1\text{ MHz}$		58		pF
C_{OSS}	$V_{\text{GS}} = 0\text{V}$	$V_{\text{DS}} = 28\text{ V}$	$f = 1\text{ MHz}$		34		pF
C_{RSS}	$V_{\text{GS}} = 0\text{V}$	$V_{\text{DS}} = 28\text{ V}$	$f = 1\text{ MHz}$		2.4		pF

DYNAMIC

Symbol	Parameter			Min.	Typ.	Max.	Unit
P_{OUT}	$V_{\text{DD}} = 28\text{V}$	$f = 945\text{ MHz}$	$I_{\text{DQ}} = 50\text{ mA}$	30			W
G_{PS}	$V_{\text{DD}} = 28\text{ V}$	$P_{\text{out}} = 30\text{ W}$	$I_{\text{DQ}} = 50\text{ mA}$	13	14		dB
η_{D}	$V_{\text{DD}} = 28\text{ V}$	$P_{\text{out}} = 30\text{ W}$	$I_{\text{DQ}} = 50\text{ mA}$	50	60		%
Load Mismatch	$f = 945\text{ MHz}$	$V_{\text{DD}} = 28\text{ V}$	$P_{\text{out}} = 30\text{ W}$	$I_{\text{DQ}} = 50\text{ mA}$	10:1		VSWR
	ALL PHASE ANGLES						

TYPICAL PERFORMANCE (CW)

Output Power vs Input Power

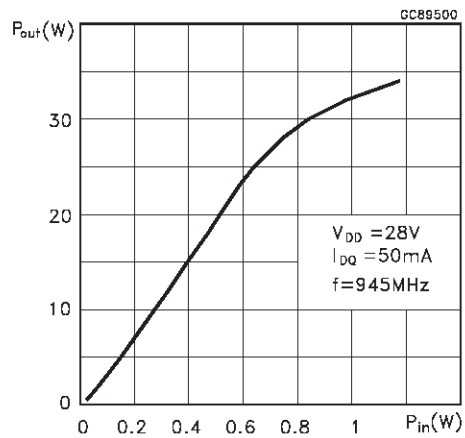

Power Gain and Efficiency vs Output Power

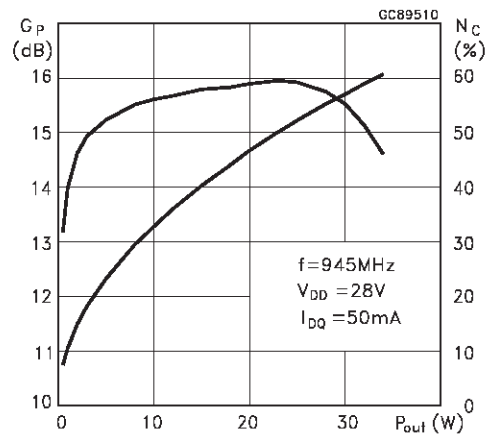

Output Power vs Supply Voltage

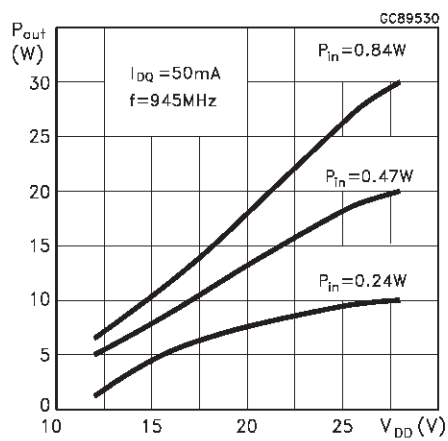

Output Power vs Gate Source Voltage

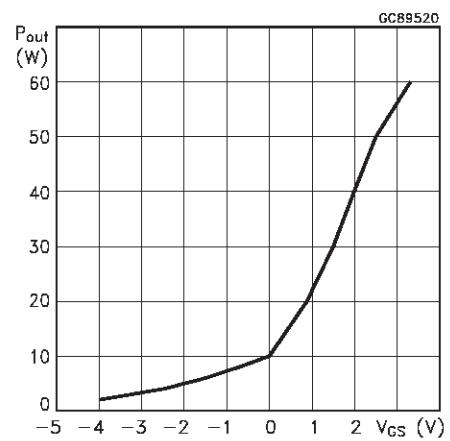

945 MHz Test Circuit Schematic

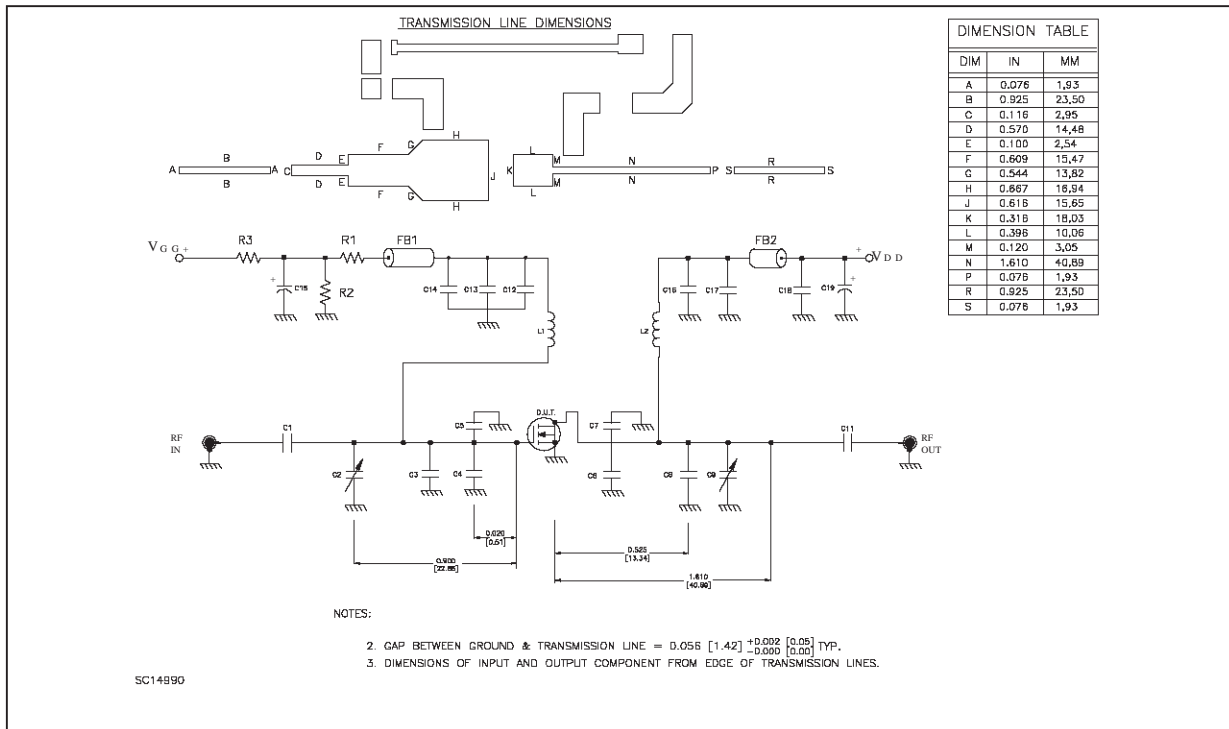

945 MHz Test Circuit Component Part List

COMPONENT	PART NO	VENDOR	DESCRIPTION
C19	SME63VB221M10X20L	UNITED CHEMI-CON	220µF/63V ALUMINUM ELECTROLYTIC RADIAL LEAD CAPACITOR
C18	C1812X7R501-104KNE	VENKEL	D.1µF/500V SURFACE MOUNT CERAMIC CHIP CAPACITOR
C17	ATC100B101KW500X	ATC	100pF ATC 100B SURFACE MOUNT CERAMIC CHIP CAPACITOR
C16	ATC100B470KW500X	ATC	47pF ATC 100B SURFACE MOUNT CERAMIC CHIP CAPACITOR
C15	SKR100M1JD11	MALLORY	10µF/50V ALUMINUM ELECTROLYTIC RADIAL LEAD CAPACITOR
C14	C1812X7R501-104KNE	VENKEL	D.1µF/500V SURFACE MOUNT CERAMIC CHIP CAPACITOR
C13	ATC700B102MW50X	ATC	1000pF ATC 700B SURFACE MOUNT CERAMIC CHIP CAPACITOR
C12	ATC100B470KW500X	ATC	47pF ATC 100B SURFACE MOUNT CERAMIC CHIP CAPACITOR
C11	ATC100B470KW500X	ATC	47pF ATC 100B SURFACE MOUNT CERAMIC CHIP CAPACITOR
C9	27291PC	JOHANSON	0.8-8.0pF GIGA TRIM VARIABLE CAPACITOR
C8	ATC100B6R2KW500X	ATC	6.2pF ATC 100B SURFACE MOUNT CERAMIC CHIP CAPACITOR
C7	ATC100B100KW500X	ATC	10pF ATC 100B SURFACE MOUNT CERAMIC CHIP CAPACITOR
C6	ATC100B100KW500X	ATC	10pF ATC 100B SURFACE MOUNT CERAMIC CHIP CAPACITOR
C5	ATC100B100KW500X	ATC	10pF ATC 100B SURFACE MOUNT CERAMIC CHIP CAPACITOR
C4	ATC100B100KW500X	ATC	10pF ATC 100B SURFACE MOUNT CERAMIC CHIP CAPACITOR
C3	ATC100B3ROCW500X	ATC	3pF ATC 100B SURFACE MOUNT CERAMIC CHIP CAPACITOR
C2	27291PC	JOHANSON	0.8-8.0pF GIGA TRIM VARIABLE CAPACITOR
C1	ATC100B470KW500X	ATC	47pF ATC 100B SURFACE MOUNT CERAMIC CHIP CAPACITOR
R3	CR2010-2W-475JT	VENKEL	120 OHM, 2W SURFACE MOUNT CHIP RESISTOR
R2	CR2512-1W-183JT	VENKEL	4.7M OHM 1W SURFACE MOUNT CHIP RESISTOR
R1	CR2512-1W-121JT	VENKEL	18K OHM, 1W SURFACE MOUNT CHIP RESISTOR
FB2	2743021447	FAIR-RITE CORP.	SHIELD BEAD SURFACE MOUNT EMI
FB1	2743019447	FAIR-RITE CORP.	SHIELD BEAD SURFACE MOUNT EMI
L2	8051	BELDEN	INDUCTOR, 5TURNS AIR WOUND #22AWG, ID=0.059[1.49], NYLON COATED MAGNET WIRE
L1	8051	BELDEN	INDUCTOR, 5TURNS AIR WOUND #22AWG, ID=0.059[1.49], NYLON COATED MAGNET WIRE
PCB	G0300M1026	ROGERS CORP.	WOVEN FIBERGLASS REINFORCED PTFE 0.080" THK, εr=2.55, 2 Oz EDCU BOTH SIDE

SC15010

945 MHz Test Circuit Photomaster

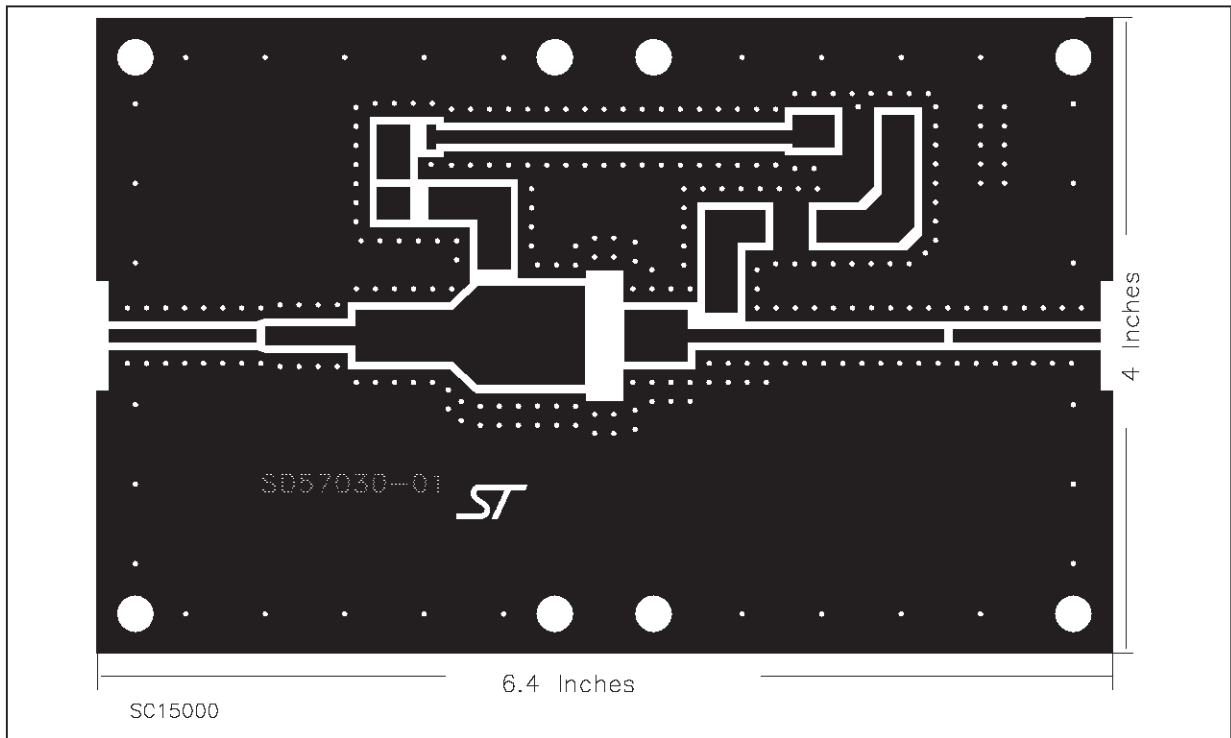

945 MHz Test Fixture

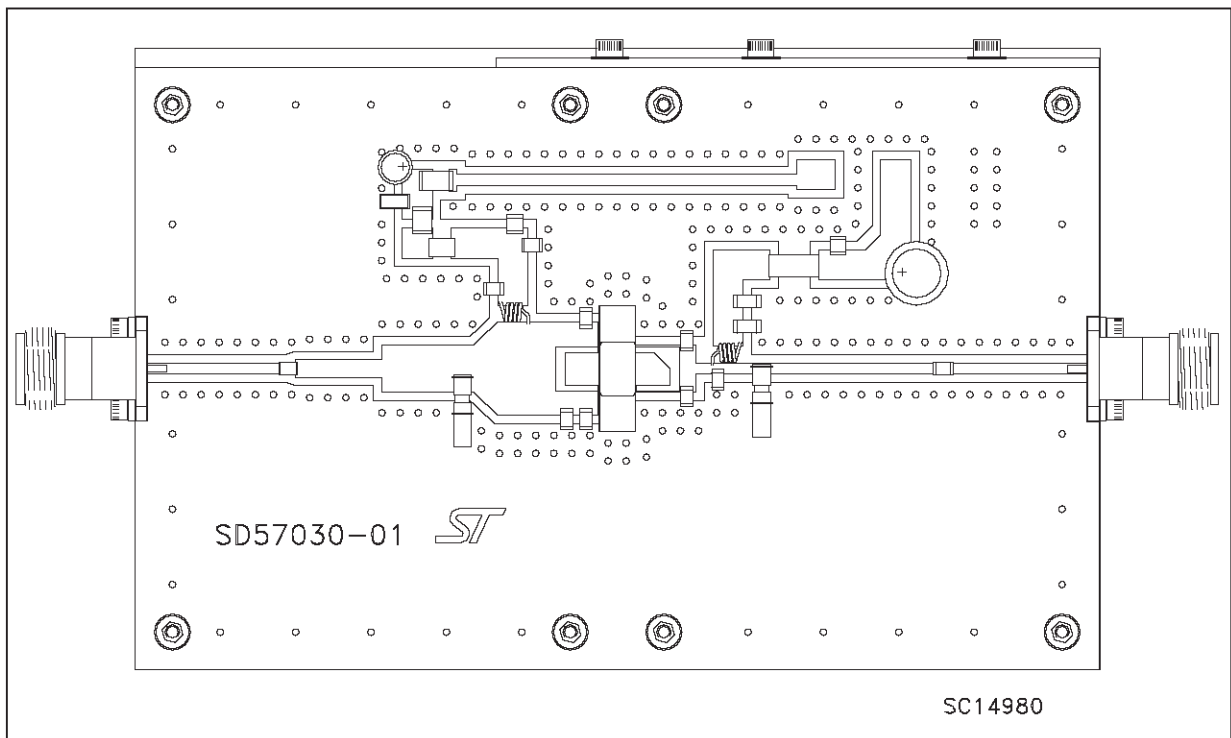

M250 (.230 x .360 WIDE 2/L N/HERM PILL) MECHANICAL DATA

DIM.	mm			inch		
	MIN.	TYP.	MAX.	MIN.	TYP.	MAX.
A	5.21		5.71	0.205		0.225
B	2.16		2.92	0.085		0.115
C	5.59		6.09	0.220		0.240
D	8.89		9.40	0.350		0.370
E	9.40		9.91	0.370		0.390
F	0.11		0.15	0.004		0.006
G	0.89		1.14	0.035		0.045
H	1.45		1.70	0.057		0.067
I	2.67		3.94	0.105		0.155

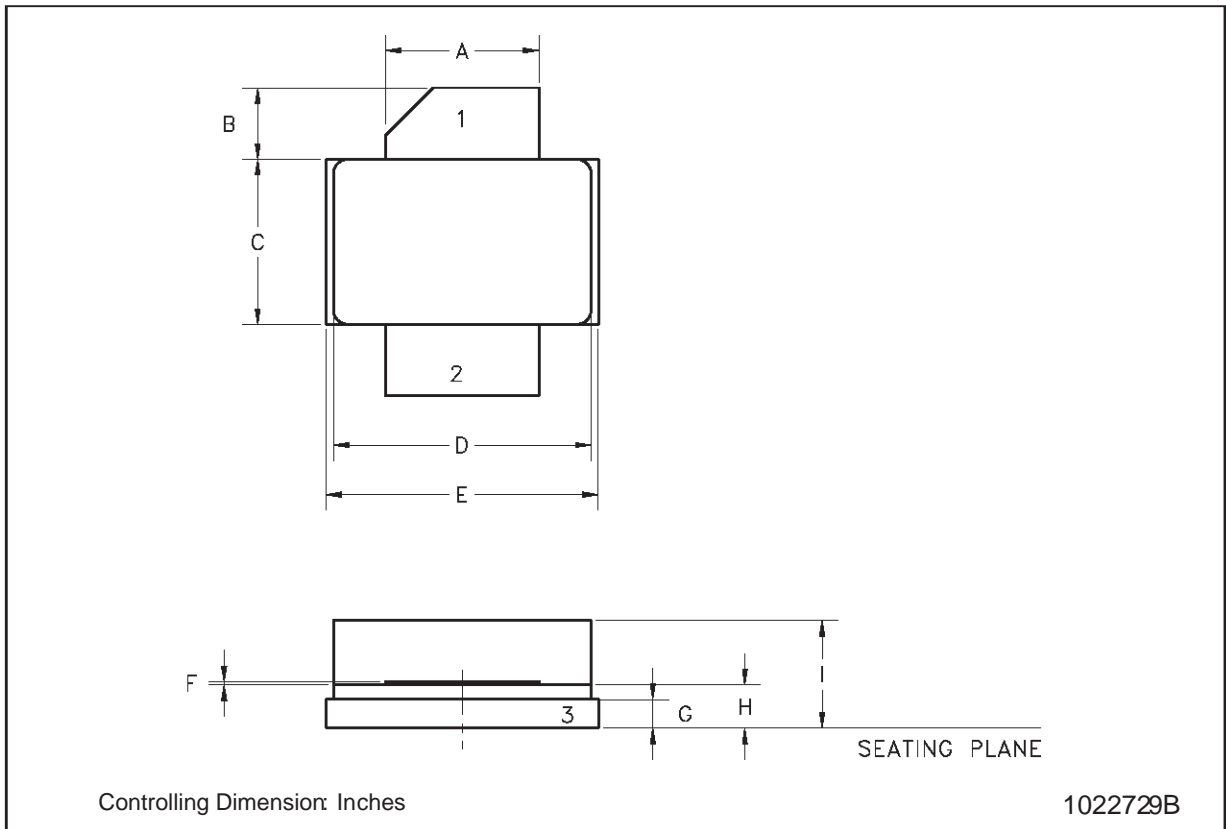

Information furnished is believed to be accurate and reliable. However, STMicroelectronics assumes no responsibility for the consequences of use of such information nor for any infringement of patents or other rights of third parties which may result from its use. No license is granted by implication or otherwise under any patent or patent rights of STMicroelectronics. Specification mentioned in this publication are subject to change without notice. This publication supersedes and replaces all information previously supplied. STMicroelectronics products are not authorized for use as critical components in life support devices or systems without express written approval of STMicroelectronics.

The ST logo is a trademark of STMicroelectronics

© 2000 STMicroelectronics – Printed in Italy – All Rights Reserved

STMicroelectronics GROUP OF COMPANIES

Australia - Brazil - China - Finland - France - Germany - Hong Kong - India - Italy - Japan - Malaysia - Malta - Morocco -
Singapore - Spain - Sweden - Switzerland - United Kingdom - U.S.A.

<http://www.st.com>

