

Silicon Bidirectional Triode Thyristors

... designed for use in solid state relays, MPU interface, TTL logic and any other light industrial or consumer application. Supplied in an inexpensive TO-92 package which is readily adaptable for use in automatic insertion equipment.

- One-Piece, Injection-Molded Unibloc Package
- Sensitive Gate Triggering in Four Trigger Modes for all possible Combinations of Trigger Sources, and Especially for Circuits that Source Gate Drives
- All Diffused and Glassivated Junctions for Maximum Uniformity of Parameters and Reliability

MAXIMUM RATINGS (T_J = 25°C unless otherwise noted)

Rating	Symbol	Value	Unit
Peak Repetitive Off-State Voltage (Gate Open, T _J = -40 to +110°C)(1) 1/2 Sine Wave 50 to 60 Hz, Gate Open MAC97-4, MAC97A4 MAC97-6, MAC97A6 MAC97-8, MAC97A8	V _{DRM}	200 400 600	Volts
On-State RMS Current Full Cycle Sine Wave 50 to 60 Hz (T _C = +50°C)	I _{T(RMS)}	0.8	Amp
Peak Non-repetitive Surge Current (One Full Cycle, 60 Hz, T _A = 110°C)	I _{TSM}	8.0	Amps
Circuit Fusing Considerations T _J = -40 to +110°C (t = 8.3 ms)	I ² t	0.26	A ² s
Peak Gate Voltage (t ≤ 2.0 μs)	V _{GM}	5.0	Volts
Peak Gate Power (t ≤ 2.0 μs)	P _{GM}	5.0	Watts
Average Gate Power (T _C = 80°C, t ≤ 8.3 ms)	P _{G(AV)}	0.1	Watt
Peak Gate Current (t ≤ 2.0 μs)	I _{GM}	1.0	Amp
Operating Junction Temperature Range	T _J	-40 to +110	°C
Storage Temperature Range	T _{stg}	-40 to +150	°C

THERMAL CHARACTERISTICS

Characteristic	Symbol	Max	Unit
Thermal Resistance, Junction to Case	R _{θJC}	75	°C/W
Thermal Resistance, Junction to Ambient	R _{θJA}	200	°C/W

(1) V_{DRM} for all types can be applied on a continuous basis. Blocking voltages shall not be tested with a constant current source such that the voltage ratings of the devices are exceeded.

MAC97,A IMPROVED SERIES

(Device Date Code
9625 and Up)

Motorola preferred devices

TRIACs
0.8 AMPERE RMS
200 — 600 VOLTS

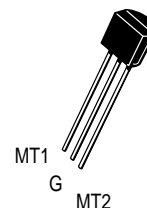
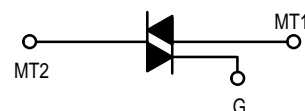

CASE 29-04
TO-226AA, STYLE 12
(TO-92)

Preferred devices are Motorola recommended choices for future use and best overall value.

MAC97,A IMPROVED SERIES

ELECTRICAL CHARACTERISTICS ($T_C = 25^\circ\text{C}$, and Either Polarity of MT2 to MT1 Voltage unless otherwise noted)

Characteristic	Symbol	Min	Typ	Max	Unit
Peak Blocking Current ⁽¹⁾ ($V_D = \text{Rated } V_{DRM}$, $T_J = 110^\circ\text{C}$, Gate Open)	I_{RRM}	—	—	0.1	mA
Peak On-State Voltage (Either Direction) ($I_{TM} = 1.1 \text{ A Peak}$; Pulse Width $\leq 2.0 \text{ ms}$, Duty Cycle $\leq 2.0\%$)	V_{TM}	—	—	1.65	Volts
Gate Trigger Current (Continuous dc) ($V_D = 12 \text{ Vdc}$, $R_L = 100 \text{ Ohms}$) MT2(+), G(+) MT2(+), G(-) MT2(-), G(-) MT2(-), G(+) MAC97 MT2(+), G(+) MT2(+), G(-) MT2(-), G(-) MT2(-), G(+) MAC97A	I_{GT}	— — — — — — — — — —	— — — — — — — — — —	10 10 10 10 5.0 5.0 5.0 7.0	mA
Gate Trigger Voltage, (Continuous dc) ($V_D = 12 \text{ Vdc}$, $R_L = 100 \text{ Ohms}$) MT2(+), G(+) MT2(+), G(-) MT2(-), G(-) MT2(-), G(+) ($V_D = \text{Rated } V_{DRM}$, $R_L = 10 \text{ k Ohms}$, $T_J = 110^\circ\text{C}$) MT2(+), G(+); MT2(-), G(-); MT2(+), G(-) MT2(-), G(+) All Types	V_{GT}	— — — — 0.1 0.1	— — — — — —	2.0 2.0 2.0 2.5 — —	Volts
Holding Current ($V_D = 12 \text{ Vdc}$, $I_{TM} = 200 \text{ mA}$, Gate Open)	I_H	—	—	5.0	mA
Gate Controlled Turn-On Time ($V_D = \text{Rated } V_{DRM}$, $I_{TM} = 1.0 \text{ A pk}$, $I_G = 25 \text{ mA}$)	t_{gt}	—	2.0	—	μs
Critical Rate-of-Rise of Commutation Voltage ($f = 250 \text{ Hz}$, $I_{TM} = 1.0 \text{ A}$, Commutating $di/dt = 1.5 \text{ A/mS}$, On-State Current Duration = 2.0 mS, $V_{DRM} = 200 \text{ V}$, Gate Unenergized, $T_C = 110^\circ\text{C}$, Gate Source Resistance = 150 Ω , See Figure 13)	dv/dt_C	1.5	—	—	$\text{V}/\mu\text{s}$
Critical Rate-of-Rise of Off State Voltage ($V_{pk} = \text{Rated } V_{DRM}$, $T_C = 110^\circ\text{C}$, Gate Open, Exponential Method)	dv/dt	10	—	—	$\text{V}/\mu\text{s}$

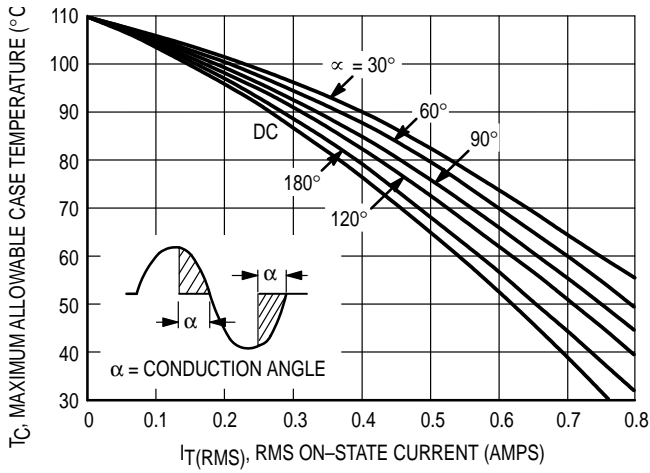

Figure 1. RMS Current Derating

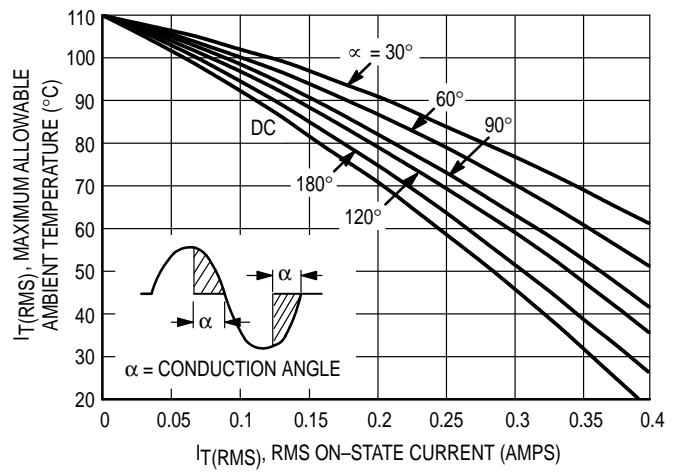

Figure 2. RMS Current Derating

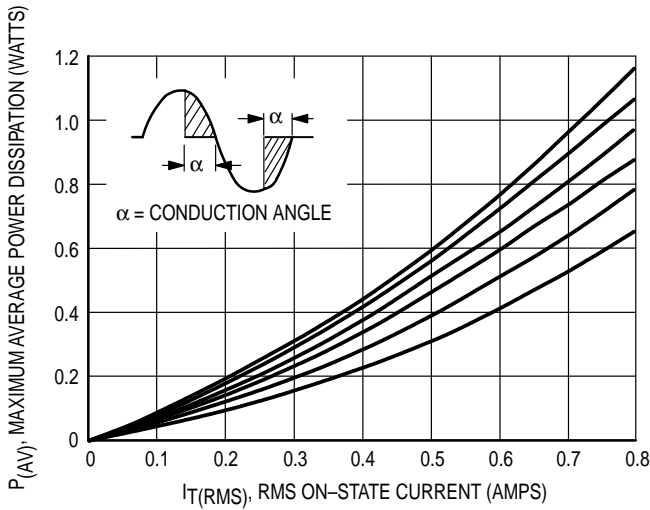

Figure 3. Power Dissipation

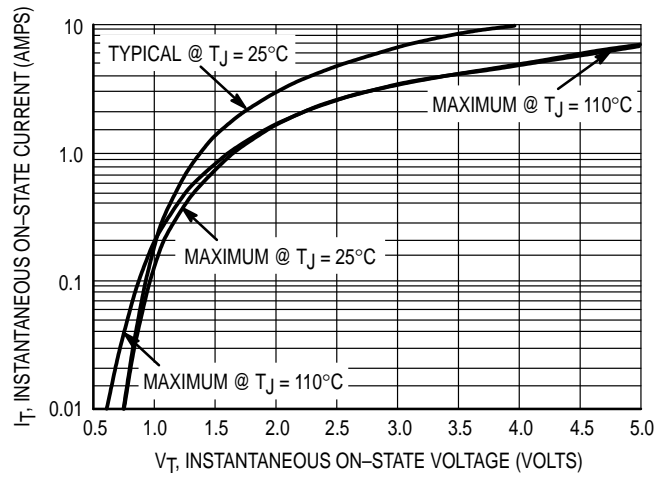

Figure 4. On-State Characteristics

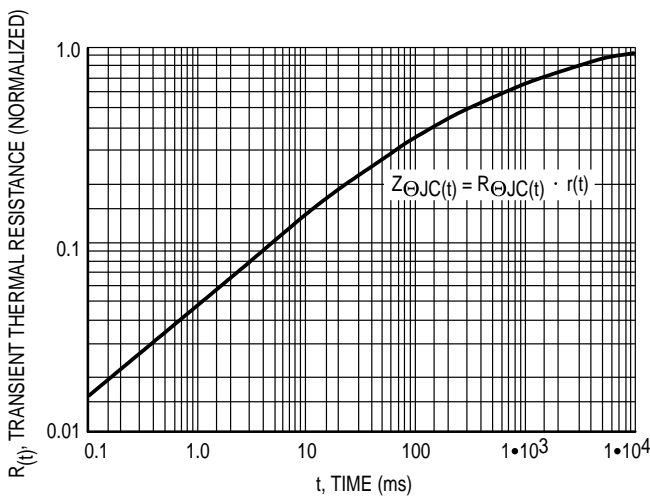

Figure 5. Transient Thermal Response

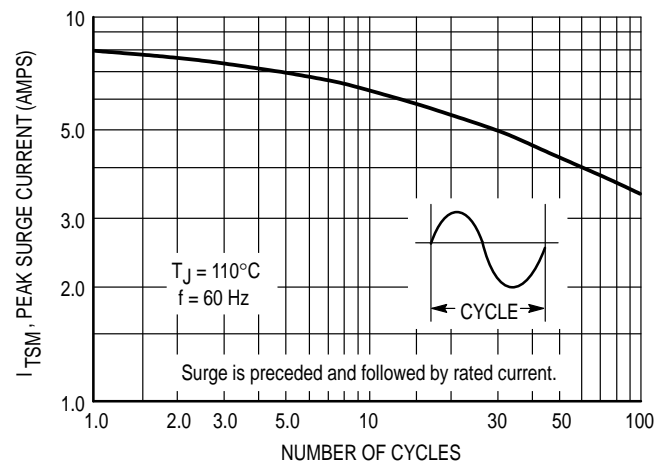

Figure 6. Maximum Allowable Surge Current

MAC97,A IMPROVED SERIES

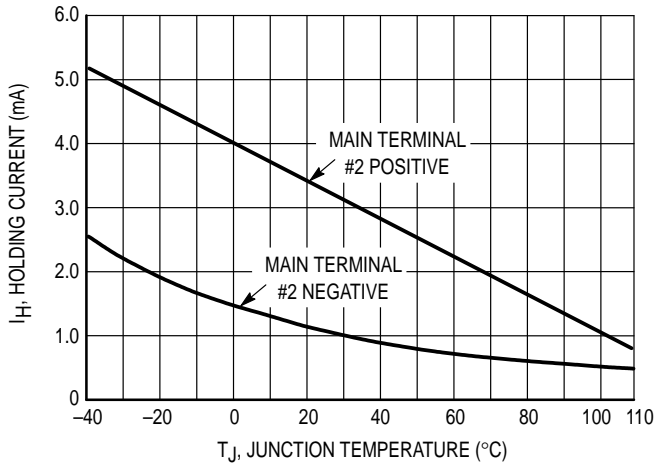

Figure 7. Typical Holding Current Variation

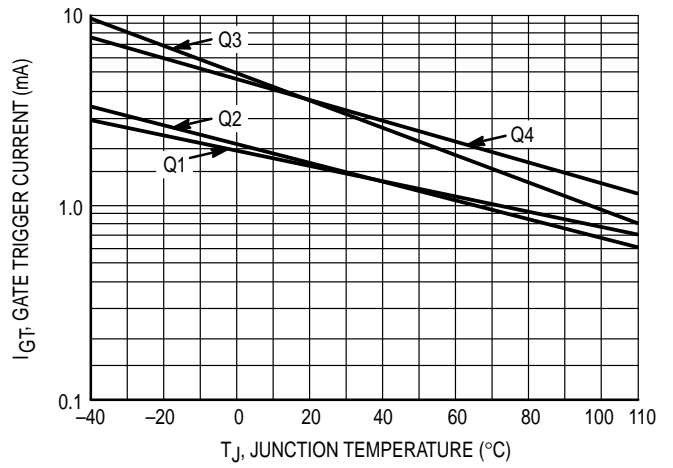

Figure 8. Typical Gate Trigger Current Variation

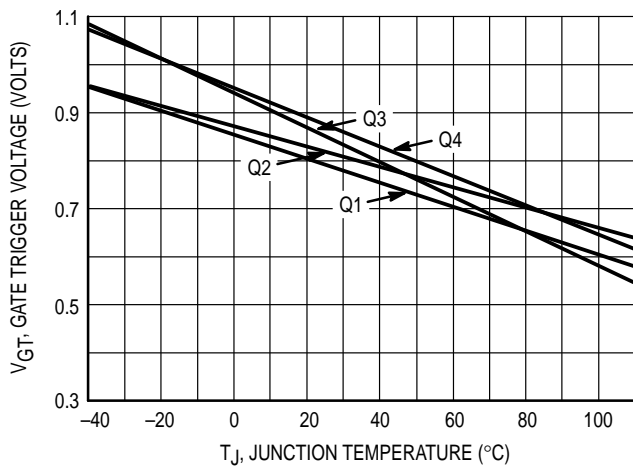

Figure 9. Gate Trigger Voltage Variation

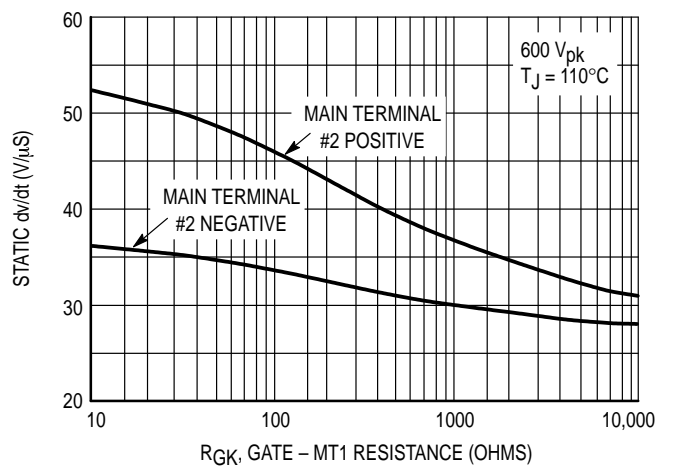

Figure 10. Exponential Static dv/dt versus Gate - MT1 Resistance

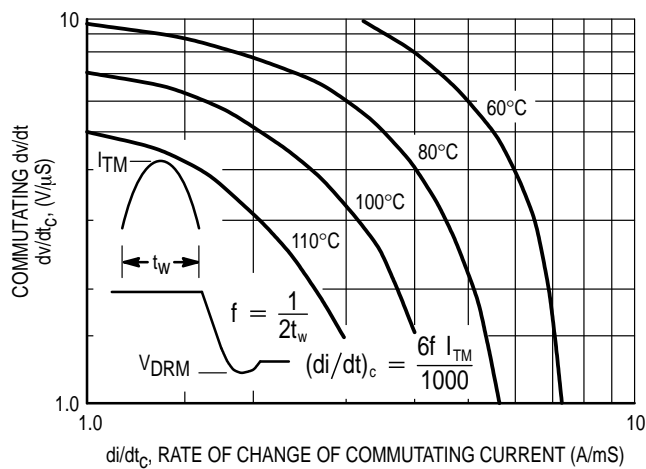

Figure 11. Typical Commutating dv/dt versus Current Crossing Rate and Junction Temperature

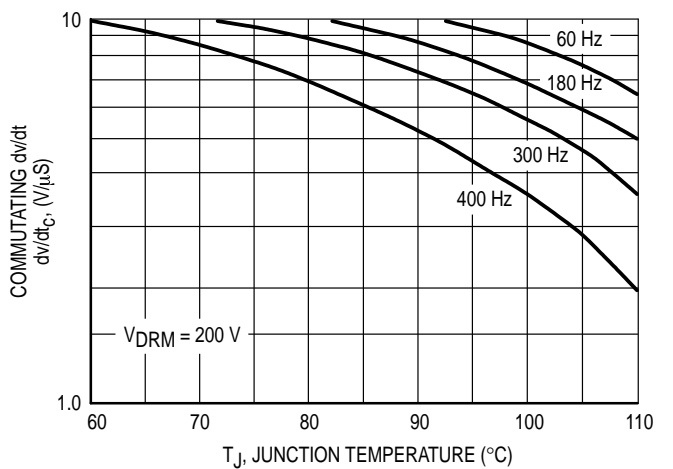
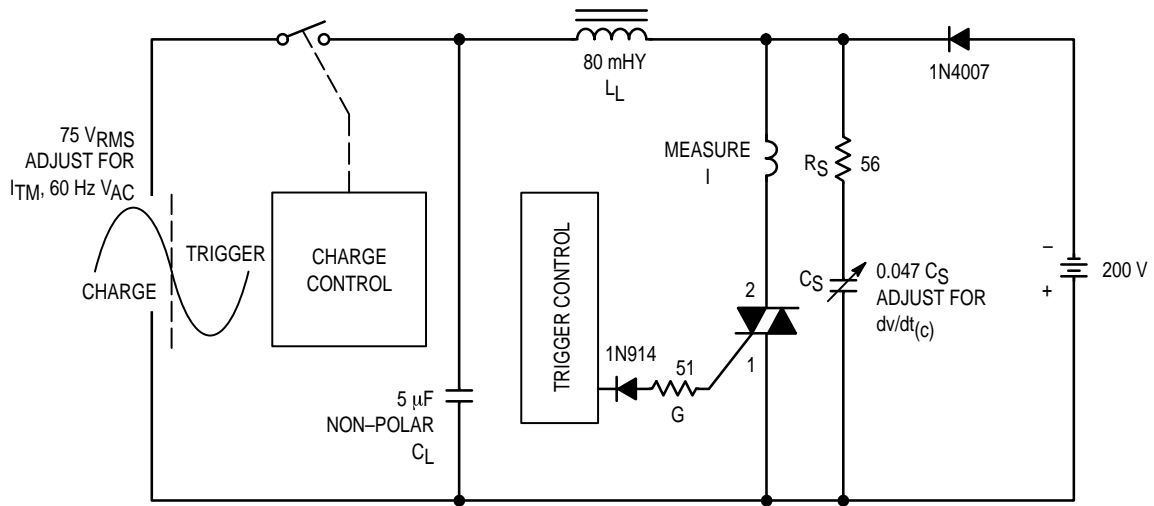

Figure 12. Typical Commutating dv/dt versus Junction Temperature at 0.8 Amps RMS



NOTE: Component values are for verification of rated $(dv/dt)_C$. See AN1048 for additional information.

Figure 13. Simplified Q₁ $(dv/dt)_C$ Test Circuit

PACKAGE DIMENSIONS

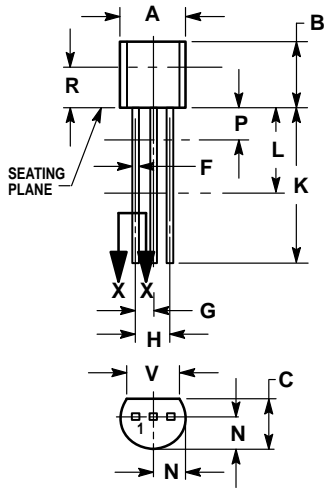

STYLE 12:
 PIN 1. MAIN TERMINAL 1
 2. GATE
 3. MAIN TERMINAL 2

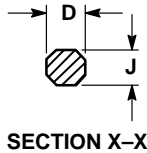

NOTES:

1. DIMENSIONING AND TOLERANCING PER ANSI Y14.5M, 1982.
2. CONTROLLING DIMENSION: INCH.
3. CONTOUR OF PACKAGE BEYOND DIMENSION R IS UNCONTROLLED.
4. DIMENSION F APPLIES BETWEEN P AND L. DIMENSION D AND J APPLY BETWEEN L AND K. MINIMUM LEAD DIMENSION IS UNCONTROLLED IN P AND BEYOND DIMENSION K MINIMUM.

DIM	INCHES		MILLIMETERS	
	MIN	MAX	MIN	MAX
A	0.175	0.205	4.45	5.20
B	0.170	0.210	4.32	5.33
C	0.125	0.165	3.18	4.19
D	0.016	0.022	0.41	0.55
F	0.016	0.019	0.41	0.48
G	0.045	0.055	1.15	1.39
H	0.095	0.105	2.42	2.66
J	0.015	0.020	0.39	0.50
K	0.500	—	12.70	—
L	0.250	—	6.35	—
N	0.080	0.105	2.04	2.66
P	—	0.100	—	2.54
R	0.115	—	2.93	—
V	0.135	—	3.43	—

**CASE 29-04
 (TO-226AA)
 (TO-92)**

Motorola reserves the right to make changes without further notice to any products herein. Motorola makes no warranty, representation or guarantee regarding the suitability of its products for any particular purpose, nor does Motorola assume any liability arising out of the application or use of any product or circuit, and specifically disclaims any and all liability, including without limitation consequential or incidental damages. "Typical" parameters which may be provided in Motorola data sheets and/or specifications can and do vary in different applications and actual performance may vary over time. All operating parameters, including "Typicals" must be validated for each customer application by customer's technical experts. Motorola does not convey any license under its patent rights nor the rights of others. Motorola products are not designed, intended, or authorized for use as components in systems intended for surgical implant into the body, or other applications intended to support or sustain life, or for any other application in which the failure of the Motorola product could create a situation where personal injury or death may occur. Should Buyer purchase or use Motorola products for any such unintended or unauthorized application, Buyer shall indemnify and hold Motorola and its officers, employees, subsidiaries, affiliates, and distributors harmless against all claims, costs, damages, and expenses, and reasonable attorney fees arising out of, directly or indirectly, any claim of personal injury or death associated with such unintended or unauthorized use, even if such claim alleges that Motorola was negligent regarding the design or manufacture of the part. Motorola and are registered trademarks of Motorola, Inc. Motorola, Inc. is an Equal Opportunity/Affirmative Action Employer.

How to reach us:

USA/EUROPE/Locations Not Listed: Motorola Literature Distribution;
 P.O. Box 20912; Phoenix, Arizona 85036. 1-800-441-2447 or 602-303-5454

JAPAN: Nippon Motorola Ltd.; Tatsumi-SPD-JLDC, 6F Seibu-Butsuryu-Center,
 3-14-2 Tatsumi Koto-Ku, Tokyo 135, Japan. 03-81-3521-8315

MFAX: RMFAX0@email.sps.mot.com - TOUCHTONE 602-244-6609
INTERNET: http://Design-NET.com

ASIA/PACIFIC: Motorola Semiconductors H.K. Ltd.; 8B Tai Ping Industrial Park,
 51 Ting Kok Road, Tai Po, N.T., Hong Kong. 852-26629298

