

**SILICON TRANSISTOR**  
**2SA1610**

**HIGH SPEED SWITCHING**  
**PNP SILICON EPITAXIAL TRANSISTOR**

**PACKAGE DIMENSIONS**  
in millimeters

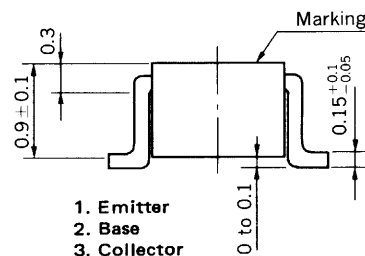
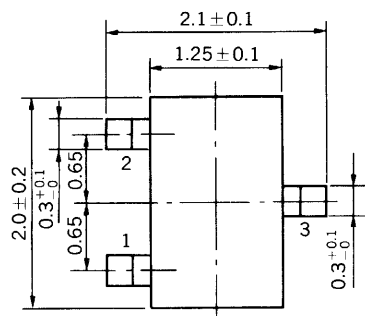

**FEATURES**

- High Speed Switching :  $t_{on} = 9.0 \text{ ns TYP.}$   
 $t_{off} = 19.0 \text{ ns TYP.}$
- High  $f_T$  :  $f_T = 1\,800 \text{ MHz TYP.}$
- Low  $C_{ob}$  :  $C_{ob} = 2.0 \text{ pF TYP.}$
- Complementary to 2SC4176

**ABSOLUTE MAXIMUM RATINGS**

Maximum Voltages and Current ( $T_a = 25^\circ\text{C}$ )

Collector to Base Voltage	$V_{CBO}$	-15	V
Collector to Emitter Voltage	$V_{CEO}$	-15	V
Emitter to Base Voltage	$V_{EBO}$	-4.5	V
Collector Current (DC)	$I_C$	-50	mA

Maximum Power Dissipation

Total power Dissipation at $25^\circ\text{C}$ Ambient Temperature	$P_T$	150	mW
--	-------	-----	----

Maximum Temperatures

Junction Temperature	$T_j$	150	$^\circ\text{C}$
Storage Temperature Range	$T_{stg}$	-55 to +150	$^\circ\text{C}$

**ELECTRICAL CHARACTERISTICS ( $T_a = 25^\circ\text{C}$ )**

CHARACTERISTIC	SYMBOL	MIN.	TYP.	MAX.	UNIT	TEST CONDITIONS
Collector Cutoff Current	$I_{CBO}$			-100	nA	$V_{CB} = -8.0 \text{ V}, I_E = 0$
Emitter Cutoff Current	$I_{EBO}$			-100	nA	$V_{EB} = -3.0 \text{ V}, I_C = 0$
DC Current Gain	$h_{FE1}^*$	30	70			$V_{CE} = -1.0 \text{ V}, I_C = -1.0 \text{ mA}$
DC Current Gain	$h_{FE2}^*$	50	80	150		$V_{CE} = -1.0 \text{ V}, I_C = -10 \text{ mA}$
Collector Saturation Voltage	$V_{CE(sat)}^*$		-0.09	-0.20	V	$I_C = -10 \text{ mA}, I_B = -1.0 \text{ mA}$
Base Saturation Voltage	$V_{BE(sat)}^*$		-0.80	-0.95	V	$I_C = -10 \text{ mA}, I_B = -1.0 \text{ mA}$
Gain Bandwidth Product	$f_T$	800	1800		MHz	$V_{CE} = -10 \text{ V}, I_E = 10 \text{ mA}$
Output Capacitance	$C_{ob}$		2.0	3.0	pF	$V_{CB} = -5.0 \text{ V}, I_E = 0, f = 1.0 \text{ MHz}$
Turn-on Time	$t_{on}$		9.0	20	ns	See Test Circuit
Storage Time	$t_{stg}$		16	40	ns	
Turn-off Time	$t_{off}$		19	40	ns	

\* Pulsed:  $PW \leq 350 \mu\text{s}$ , Duty Cycle  $\leq 2\%$

**$h_{FE2}$  Classification**

Making	Y33	Y34
$h_{FE2}$	50 to 100	75 to 150

TYPICAL CHARACTERISTICS ( $T_a = 25^\circ\text{C}$ )

TOTAL POWER DISSIPATION vs. AMBIENT TEMPERATURE

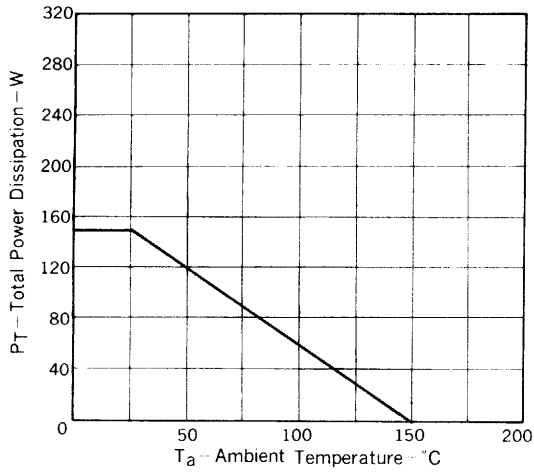

COLLECTOR CURRENT vs. COLLECTOR TO EMITTER VOLTAGE

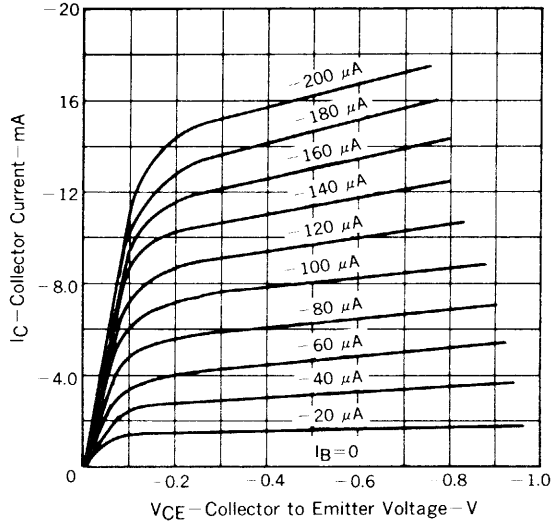

COLLECTOR CURRENT vs. BASE TO EMITTER VOLTAGE

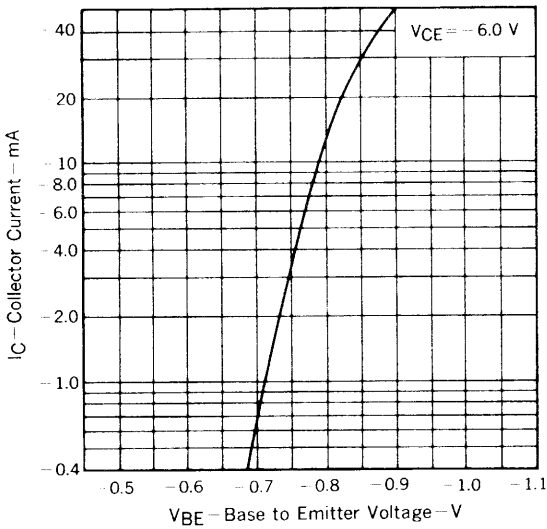

DC CURRENT GAIN vs. COLLECTOR CURRENT

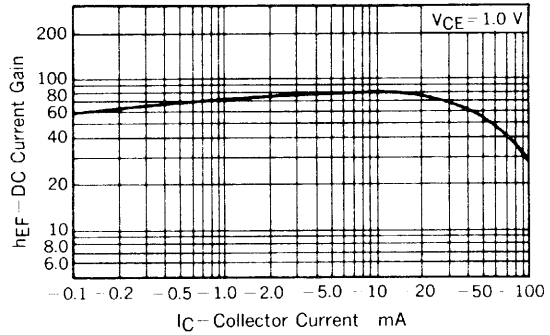

BASE AND COLLECTOR SATURATION VOLTAGE vs. COLLECTOR CURRENT

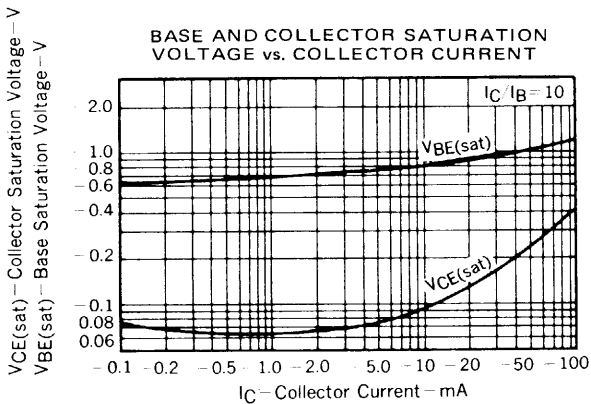

INPUT AND OUTPUT CAPACITANCE vs. REVERSE VOLTAGE

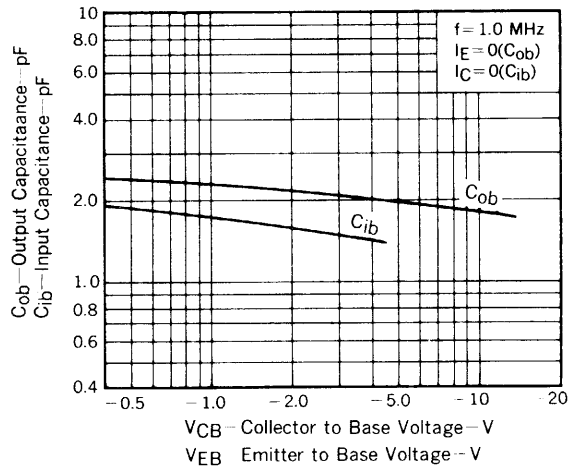

GAIN BANDWIDTH PRODUCT vs. EMITTER CURRENT

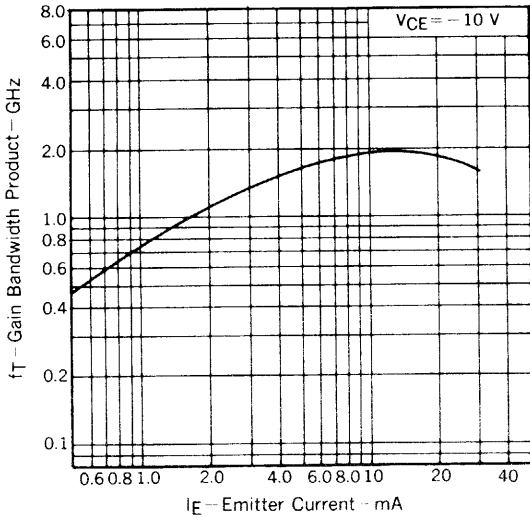

SWITCHING TIME vs. COLLECTOR CURRENT

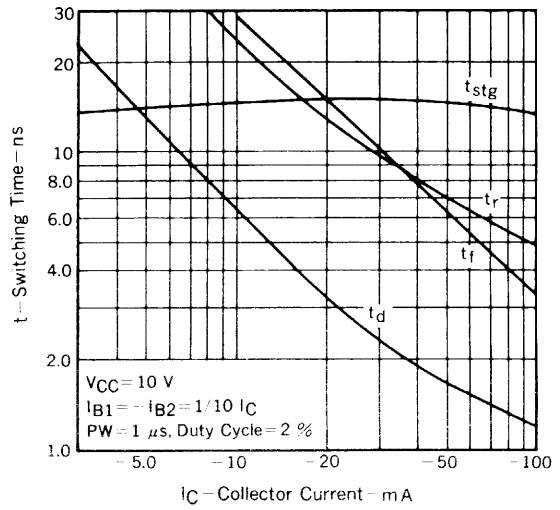

SWITCHING TIME TEST CIRCUIT

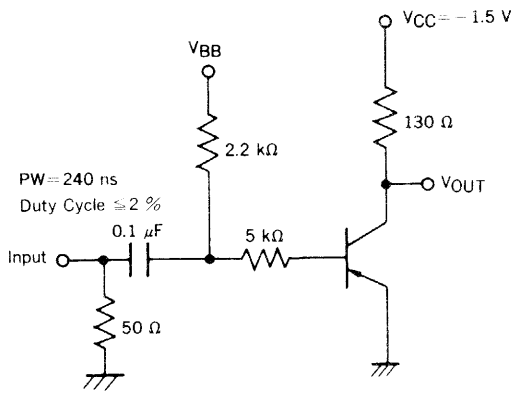

$t_{on}$ ,  $t_{off}$  Switching

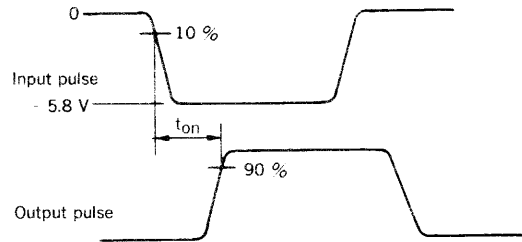

$t_{on}$  Voltage Waveforms ( $V_{BB} = \text{GROUND}$ )

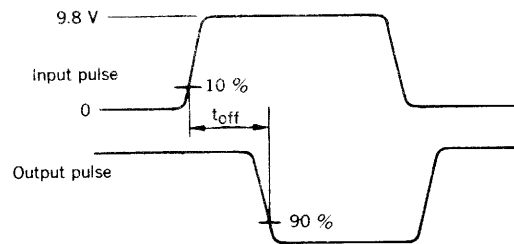

$t_{off}$  Voltage Waveforms ( $V_{BB} = -8.0 \text{ V}$ )

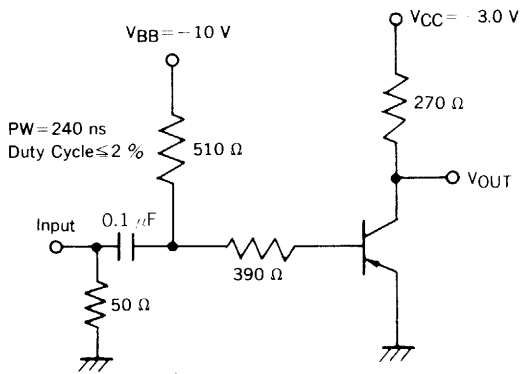

$t_{stg}$  Switching

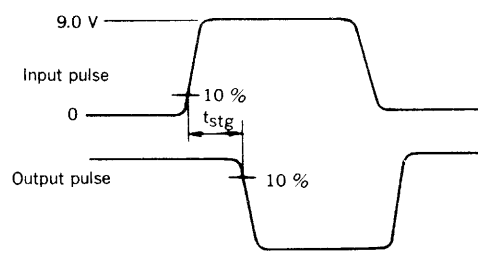

$t_{stg}$  Voltage Waveforms

