

High-Power PNP Silicon Transistors

... designed for use in industrial-military power amplifier and switching circuit applications.

- High Collector Emitter Sustaining Voltage —
 $V_{CEO(sus)} = 120 \text{ Vdc (Min) — 2N6379}$
- High DC Current Gain —
 $h_{FE} = 30-120 @ I_C = 20 \text{ Adc}$
 $= 10 \text{ (Min) } @ I_C = 50 \text{ Adc}$
- Low Collector-Emitter Saturation Voltage —
 $V_{CE(sat)} = 1.0 \text{ Vdc (Max) } @ I_C = 20 \text{ Adc}$
- Fast Switching Times @ $I_C = 20 \text{ Adc}$
 $t_r = 0.35 \mu\text{s (Max)}$
 $t_s = 0.8 \mu\text{s (Max)}$
 $t_f = 0.25 \mu\text{s (Max)}$
- Complement to 2N6274-77

2N6379*

*Motorola Preferred Device

**50 AMPERE
POWER TRANSISTORS
PNP SILICON
80, 100, 120 VOLTS
250 WATTS**

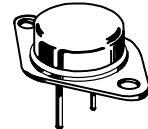

**CASE 197A-05
TO-204AE
(TO-3)**

*MAXIMUM RATINGS

Rating	Symbol	Value	Unit
Collector-Base Voltage	V_{CB}	140	Vdc
Collector-Emitter Voltage	V_{CEO}	120	Vdc
Emitter-Base Voltage	V_{EB}	6.0	Vdc
Collector Current — Continuous Peak	I_C	50 100	Adc
Base Current	I_B	20	Adc
Total Device Dissipation @ $T_C = 25^\circ\text{C}$ Derate above 25°C	P_D	250 1.43	Watts W/ $^\circ\text{C}$
Operating and Storage Junction Temperature Range	T_J, T_{stg}	-65 to +200	$^\circ\text{C}$

THERMAL CHARACTERISTICS

Characteristic	Symbol	Max	Unit
Thermal Resistance, Junction to Case	θ_{JC}	0.7	$^\circ\text{C/W}$

* Indicates JEDEC Registered Data.

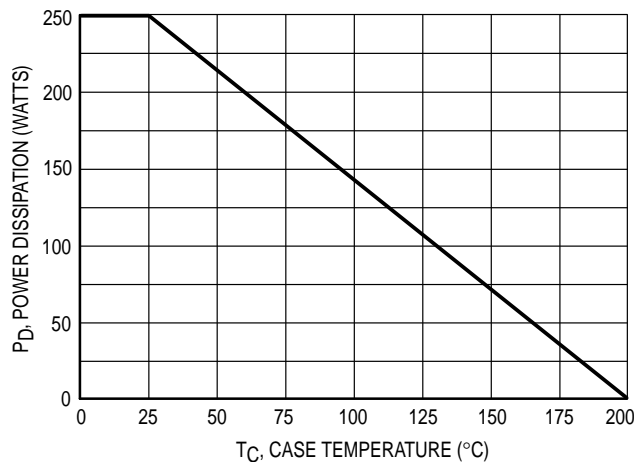

Figure 1. Power Derating

Preferred devices are Motorola recommended choices for future use and best overall value.

REV 7

ELECTRICAL CHARACTERISTICS ($T_C = 25^\circ\text{C}$ unless otherwise noted)

Characteristic	Symbol	Min	Max	Unit
*OFF CHARACTERISTICS				
Collector–Emitter Sustaining Voltage ⁽¹⁾ ($I_C = 50\text{ mAdc}$, $I_B = 0$)	$V_{CEO(sus)}$	120	—	Vdc
Collector Cutoff Current ($V_{CE} = 70\text{ Vdc}$, $I_B = 0$)	I_{CEO}	—	50	μAdc
Collector Cutoff Current ($V_{CE} = 90\%$ Rated V_{CB} , $V_{BE(off)} = 1.5\text{ Vdc}$) ($V_{CE} = 90\%$ Rated V_{CB} , $V_{BE(off)} = 1.5\text{ Vdc}$, $T_C = 150^\circ\text{C}$)	I_{CEX}	—	10 1.0	μAdc mAdc
Emitter Cutoff Current ($V_{EB} = 6.0\text{ Vdc}$, $I_C = 0$)	I_{EBO}	—	100	μAdc

***ON CHARACTERISTICS(1)**

DC Current Gain ($I_C = 1.0\text{ Adc}$, $V_{CE} = 4.0\text{ Vdc}$) ($I_C = 20\text{ Adc}$, $V_{CE} = 4.0\text{ Vdc}$) ($I_C = 50\text{ Adc}$, $V_{CE} = 4.0\text{ Vdc}$)	h_{FE}	50 30 10	— 120 —	—
Collector–Emitter Saturation Voltage ($I_C = 20\text{ Adc}$, $I_B = 2.0\text{ Adc}$) ($I_C = 50\text{ Adc}$, $I_B = 10\text{ Adc}$)	$V_{CE(sat)}$	— — —	— 1.2 3.0	Vdc
Base–Emitter Saturation Voltage ($I_C = 20\text{ Adc}$, $I_B = 2.0\text{ Adc}$) ($I_C = 50\text{ Adc}$, $I_B = 10\text{ Adc}$)	$V_{BE(sat)}$	— — —	— 1.8 3.5	Vdc

DYNAMIC CHARACTERISTICS

*Current–Gain — Bandwidth Product ⁽²⁾ ($I_C = 1.0\text{ Adc}$, $V_{CE} = 10\text{ Vdc}$, $f_{test} = 10\text{ MHz}$)	f_T	30	—	MHz
*Output Capacitance ($V_{CB} = 10\text{ Vdc}$, $I_E = 0$, $f = 0.1\text{ MHz}$)	C_{ob}	—	1500	pF

***SWITCHING CHARACTERISTICS (Figure 2)**

Rise Time	$(V_{CC} = 80\text{ Vdc}$, $I_C = 20\text{ Adc}$, $I_{B1} = I_{B2} = 2.0\text{ Adc}$)	t_r	—	0.35	μs
Storage Time		t_s	—	0.80	μs
Fall Time		t_f	—	0.25	μs

* Indicates JEDEC Registered Data.

(1) Pulse Test: Pulse Width = 300 μs , Duty Cycle = 2.0%. (2) $f_T = |h_{fe}| \cdot f_{test}$

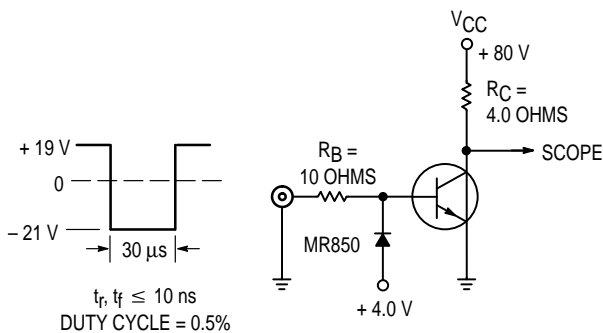

NOTE: For information on Figures 3 & 6, R_B and R_C were varied to obtain desired test conditions.

Figure 2. Switching Time Test Circuit

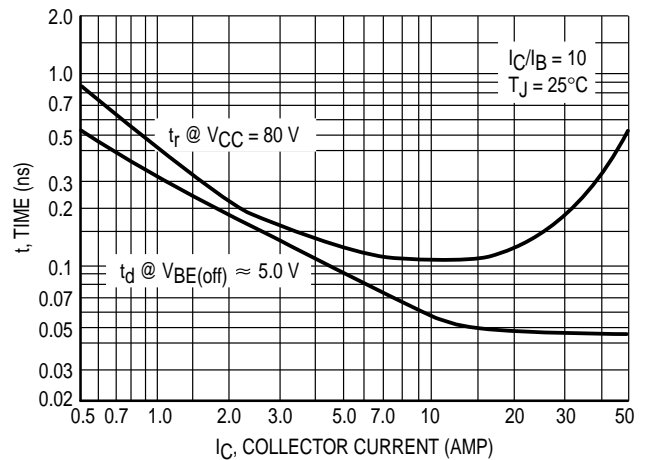

Figure 3. Turn–On Time

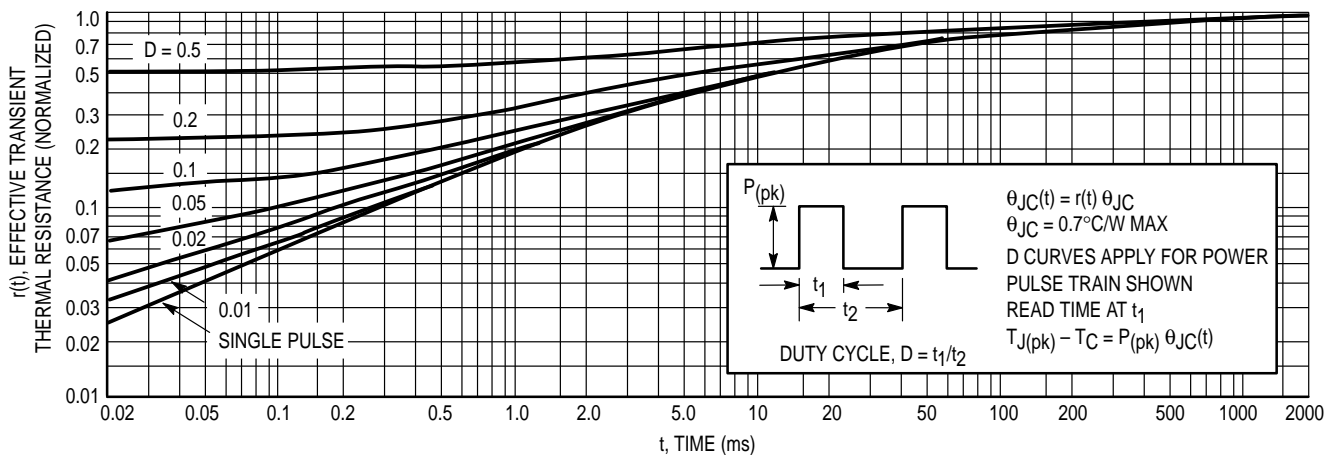

Figure 4. Thermal Response

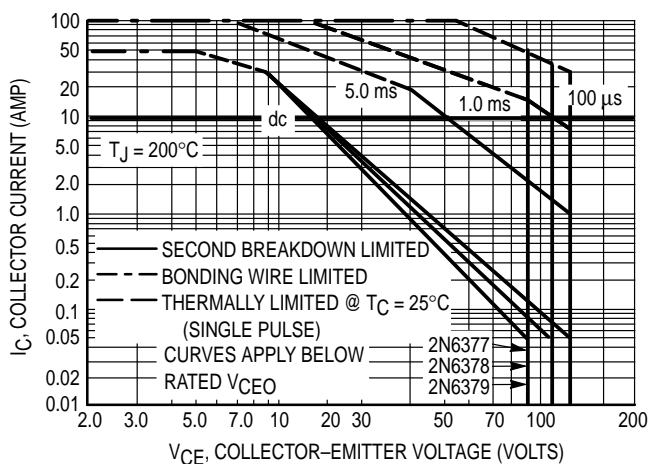

Figure 5. Active Region Safe Operating Area

There are two limitations on the power handling ability of a transistor: average junction temperature and second breakdown. Safe operating area curves indicate $I_C - V_{CE}$ limits of the transistor that must be observed for reliable operation; i.e., the transistor must not be subjected to greater dissipation than the curves indicate.

The data of Figure 5 is based on $T_{J(pk)} = 200^\circ\text{C}$; T_C is variable depending on conditions. Second breakdown pulse limits are valid for duty cycles to 10% provided $T_{J(pk)} \leq 200^\circ\text{C}$. $T_{J(pk)}$ may be calculated from the data in Figure 4. At high case temperatures, thermal limitations will reduce the power that can be handled to values less than the limitations imposed by second breakdown.

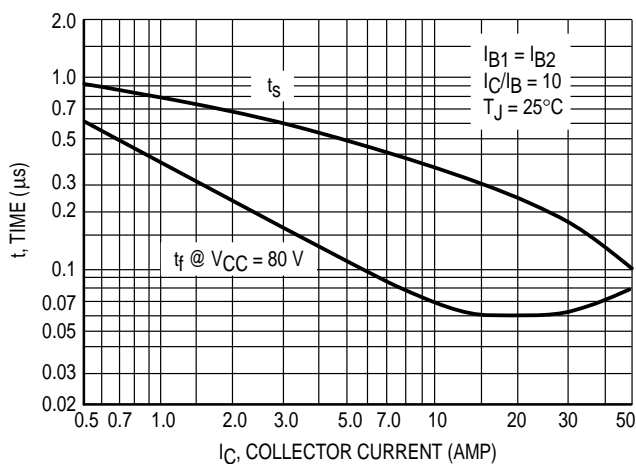

Figure 6. Turn-Off Time

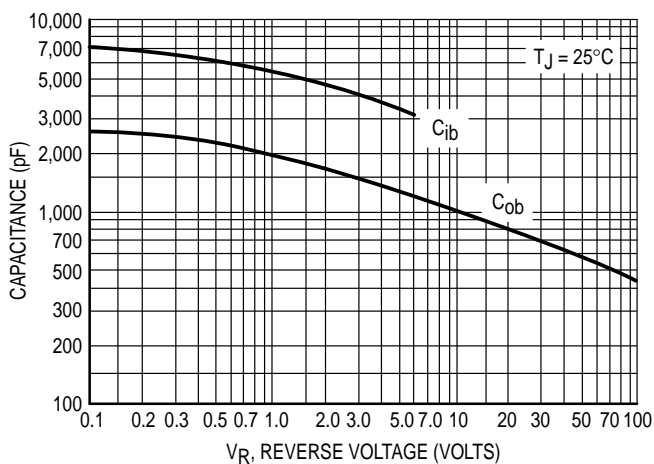

Figure 7. Capacitance

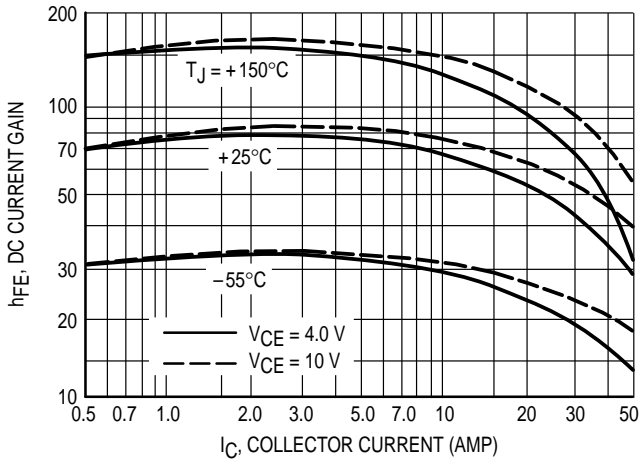

Figure 8. DC Current Gain

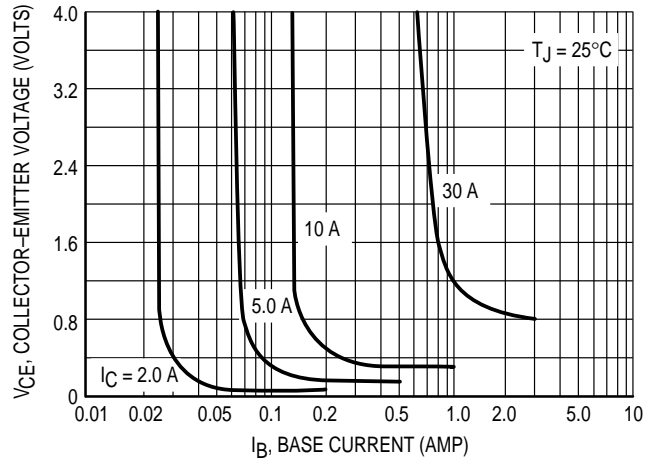

Figure 9. Collector Saturation Region

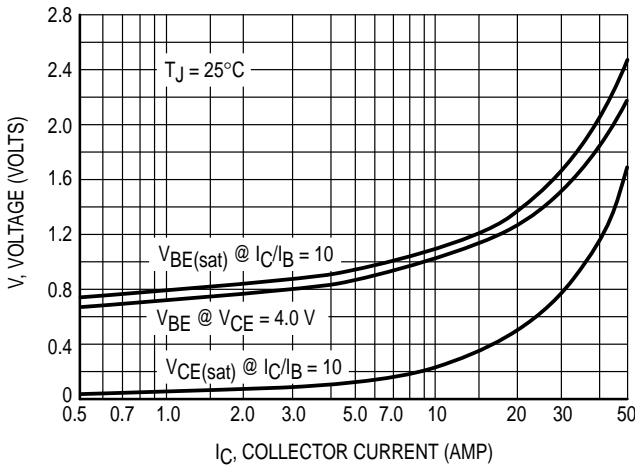

Figure 10. "On" Voltages

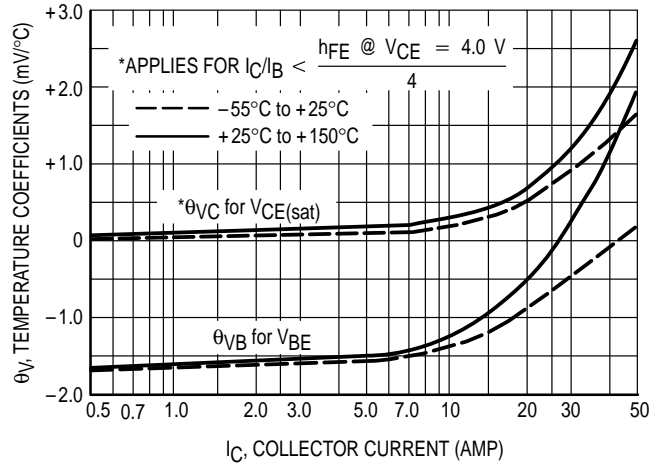

Figure 11. Temperature Coefficients

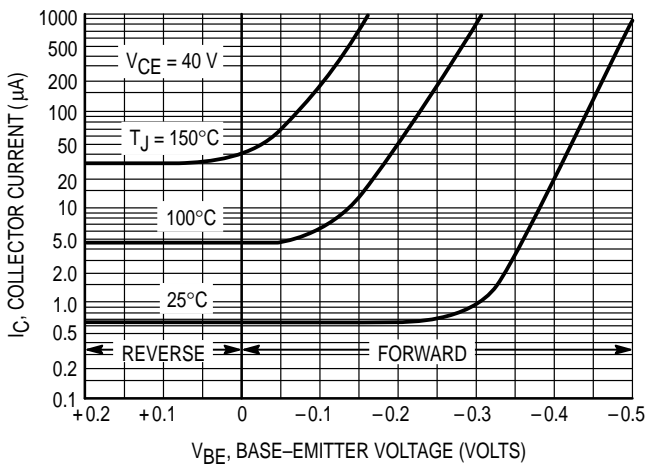

Figure 12. Collector Cut-Off Region

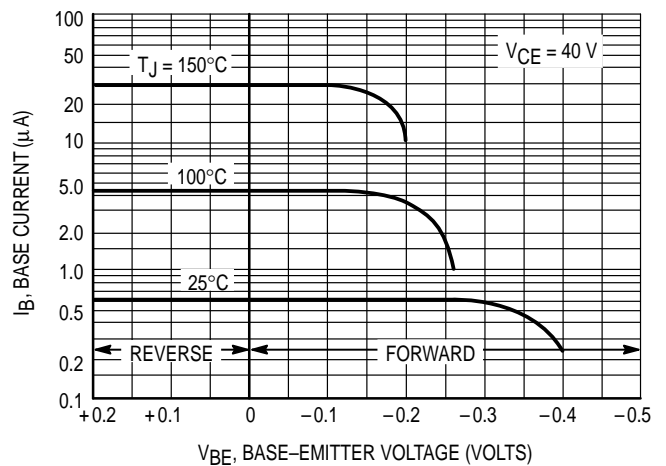
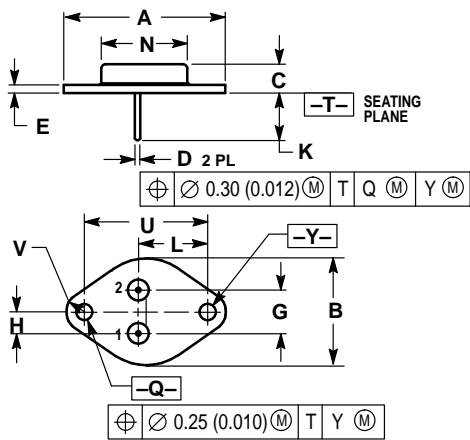

Figure 13. Base Cutoff Region

PACKAGE DIMENSIONS



- NOTES:
 1. DIMENSIONING AND TOLERANCING PER ANSI Y14.5M, 1982.
 2. CONTROLLING DIMENSION: INCH.

DIM	INCHES		MILLIMETERS	
	MIN	MAX	MIN	MAX
A	1.530 REF		38.86 REF	
B	0.990	1.050	25.15	26.67
C	0.250	0.335	6.35	8.51
D	0.057	0.063	1.45	1.60
E	0.060	0.070	1.53	1.77
G	0.430 BSC		10.92 BSC	
H	0.215 BSC		5.46 BSC	
K	0.440	0.480	11.18	12.19
L	0.665 BSC		16.89 BSC	
N	0.760	0.830	19.31	21.08
Q	0.151	0.165	3.84	4.19
U	1.187 BSC		30.15 BSC	
V	0.131	0.188	3.33	4.77

- STYLE 1:
 PIN 1: BASE
 2: EMITTER
 CASE: COLLECTOR

CASE 197A-05
 TO-204AE (TO-3)
 ISSUE J

Motorola reserves the right to make changes without further notice to any products herein. Motorola makes no warranty, representation or guarantee regarding the suitability of its products for any particular purpose, nor does Motorola assume any liability arising out of the application or use of any product or circuit, and specifically disclaims any and all liability, including without limitation consequential or incidental damages. "Typical" parameters can and do vary in different applications. All operating parameters, including "Typicals" must be validated for each customer application by customer's technical experts. Motorola does not convey any license under its patent rights nor the rights of others. Motorola products are not designed, intended, or authorized for use as components in systems intended for surgical implant into the body, or other applications intended to support or sustain life, or for any other application in which the failure of the Motorola product could create a situation where personal injury or death may occur. Should Buyer purchase or use Motorola products for any such unintended or unauthorized application, Buyer shall indemnify and hold Motorola and its officers, employees, subsidiaries, affiliates, and distributors harmless against all claims, costs, damages, and expenses, and reasonable attorney fees arising out of, directly or indirectly, any claim of personal injury or death associated with such unintended or unauthorized use, even if such claim alleges that Motorola was negligent regarding the design or manufacture of the part. Motorola and  are registered trademarks of Motorola, Inc. Motorola, Inc. is an Equal Opportunity/Affirmative Action Employer.

How to reach us:

USA / EUROPE: Motorola Literature Distribution;
P.O. Box 20912; Phoenix, Arizona 85036. 1-800-441-2447

JAPAN: Nippon Motorola Ltd.; Tatsumi-SPD-JLDC, Toshikatsu Otsuki,
6F Seibu-Butsuryu-Center, 3-14-2 Tatsumi Koto-Ku, Tokyo 135, Japan. 03-3521-8315

MFAX: RMFAX0@email.sps.mot.com – TOUCHTONE (602) 244-6609
INTERNET: <http://Design-NET.com>

HONG KONG: Motorola Semiconductors H.K. Ltd.; 8B Tai Ping Industrial Park,
51 Ting Kok Road, Tai Po, N.T., Hong Kong. 852-26629298

