

MOS INTEGRATED CIRCUIT

μ PD482234, 482235

2M-Bit Dual Port Graphics Buffer

256K-WORD BY 8-BIT

Description

The μ PD482234 and μ PD482235 have a random access port and a serial access port. The random access port has a 2M-bit (262, 144 words \times 8 bits) memory cell array structure. The serial access port can perform clock operations of up to 55 MHz from the 4K-bit data register (512 words \times 8 bits).

To simplify the graphics system design, the split data transfer function and binary boundary jump function have been adopted so that the number of split data registers can be programmed with the software during serial read/write operations.

The μ PD482235 is provided with the hyper page mode, an improved version of the fast page mode of the μ PD482234. The random access port can input and output data by $\overline{\text{CAS}}$ clock operations of up to 33 MHz.

Features

Dual port structure (Random access port, Serial access port)

- Random access port (262, 144-word \times 8-bit structure)

μ PD482234

	μ PD482234-60	μ PD482234-70
$\overline{\text{RAS}}$ access time	60 ns (MAX.)	70 ns (MAX.)
Fast page mode cycle time	40 ns (MIN.)	45 ns (MIN.)

μ PD482235

	μ PD482235-60	μ PD482235-70
$\overline{\text{RAS}}$ access time	60 ns (MAX.)	70 ns (MAX.)
Hyper page mode cycle time	30 ns (MIN.)	35 ns (MIN.)

- Flash write function^{Note}
- Block write function (4 columns)^{Note}
- Mask write (Write-per-bit function)
- 512 refresh cycles / 8 ms
- $\overline{\text{CAS}}$ before $\overline{\text{RAS}}$ refresh, $\overline{\text{RAS}}$ only refresh, Hidden refresh

Note Write-per-bit can be specified.

The information in this document is subject to change without notice.

- Serial access port (512 words × 8 bits organization)
- Serial read/write cycle time

μPD482234-60, 482235-60	μPD482234-70, 482235-70
18 ns (MIN.)	22 ns (MIN.)

- Serial data read/write
- Split buffer data transfer
- Binary boundary jump function

Version B, A, F, and E

There are four versions, B, A, F, and E, to both the μPD482234 and μPD482235. This data sheet can be applied to the versions B and A.

• **How to identify each version**

Each version is identified with its lot number (Refer to **7. Example of Stamping**).

Ordering Information

Part Number	RAS Access Time ns (MAX.)	Package	Page Mode
μPD482234LE-60	60	40-pin plastic SOJ (400mil)	Fast page mode
μPD482234LE-70	70		
μPD482234G5-60	60	44-pin plastic TSOP (II) (400mil)	
μPD482234G5-70	70		
μPD482235LE-60	60	40-pin plastic SOJ (400mil)	Hyper page mode
μPD482235LE-70	70		
μPD482235G5-60	60	44-pin plastic TSOP (II) (400mil)	
μPD482235G5-70	70		

Pin Configurations (Marking Side)

40-pin plastic SOJ (400 mil)

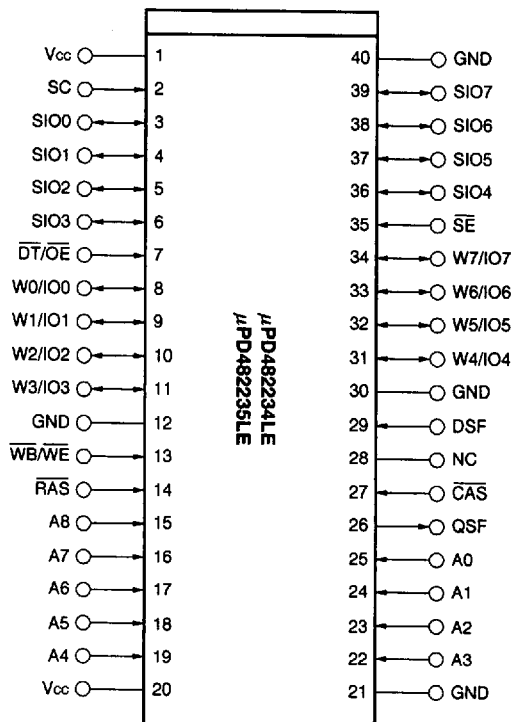

- A0 to A8 : Address inputs
- W0 to W7/IO0 to IO7 : Mask data selects/Data inputs and outputs
- SIO0 to SIO7 : Serial data inputs and outputs
- RAS : Row address strobe
- CAS : Column address strobe
- DT/OE : Data transfer/Output enable
- WB/WE : Write-per-bit/Write enable
- SE : Serial data input/Output enable
- SC : Serial clock
- QSF : Special function output
- DSF : Special function enable
- Vcc : Power supply voltage
- GND : Ground
- NC^{Note} : No connection

Note Some signals can be applied because this pin is not connected to the inside of the chip.

44-pin plastic TSOP (II) (400 mil)

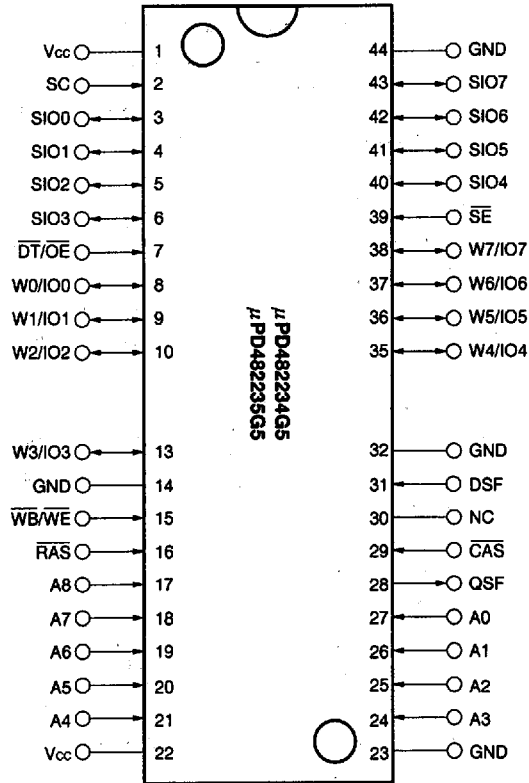

- A0 to A8 : Address inputs
- W0 to W7/IO0 to IO7 : Mask data selects/Data inputs and outputs
- SIO0 to SIO7 : Serial data inputs and outputs
- RAS : Row address strobe
- CAS : Column address strobe
- DT/OE : Data transfer/Output enable
- WB, WE : Write-per-bit/Write enable
- SE : Serial data input/Output enable
- SC : Serial clock
- QSF : Special function output
- DSF : Special function enable
- Vcc : Power supply voltage
- GND : Ground
- NC^{Note} : No connection

Note Some signals can be applied because this pin is not connected to the inside of the chip.

[MEMO]

PAGE(S) INTENTIONALLY BLANK

Block Diagram

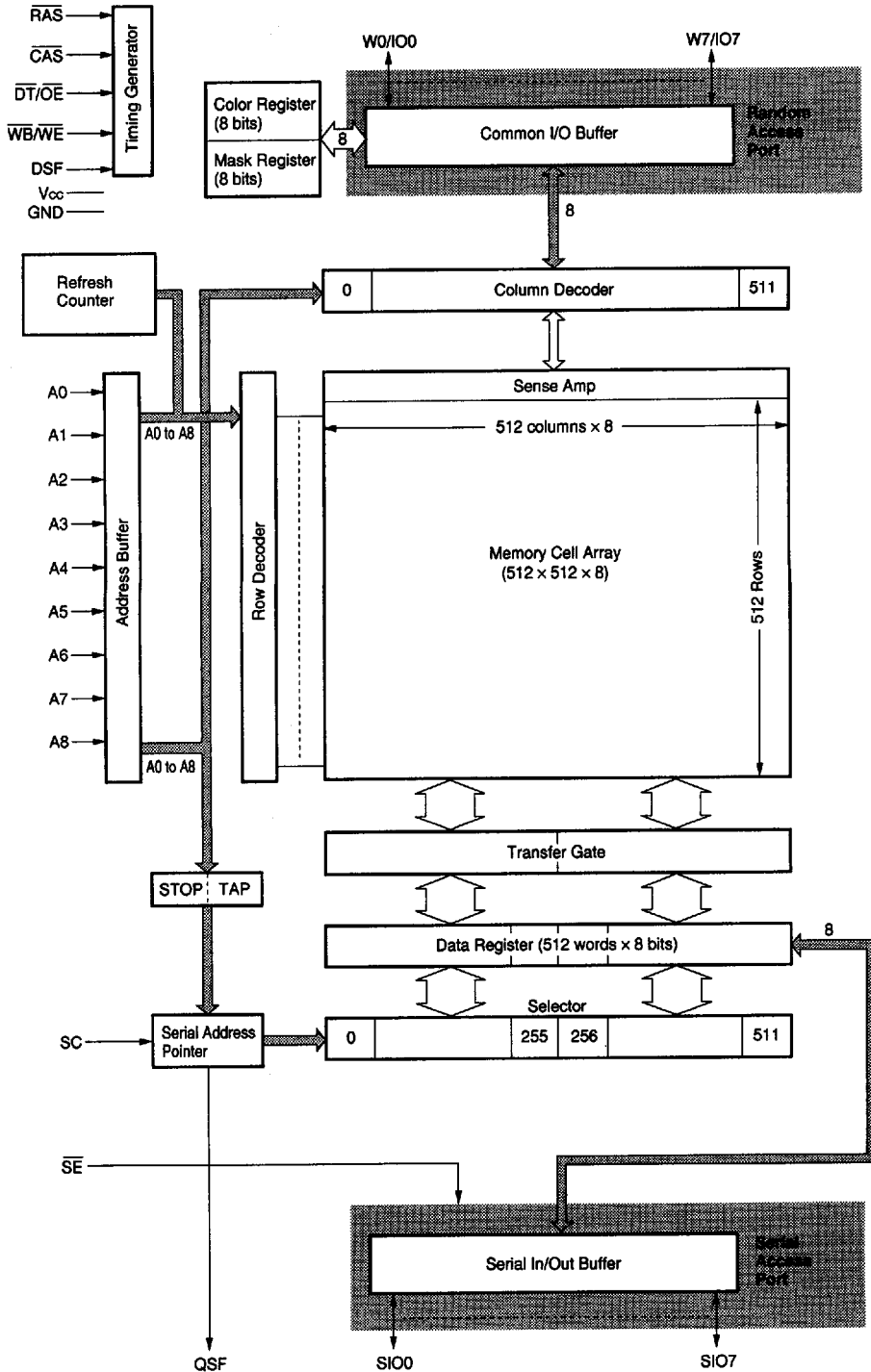

1. Pin Functions

This product is equipped with the \overline{RAS} , \overline{CAS} , $\overline{WB/WE}$, $\overline{DT/OE}$, A0 to A8, DSF, SC, \overline{SE} inputs, QSF output, and W0 to W7/IO0 to IO7, SIO0 to SIO7 input/output pins.

(1/3)

Pin Name	Input/ Output	Function
\overline{RAS} (Row address strobe)	Input	<p>This signal latches the row addresses (A0 to A8), selects the corresponding word line, and activates the sense amplifier. It also refreshes the memory cell array of the one line (4,096 bits) selected from the row addresses (A0 to A8).</p> <p>It also serves as the signal which selects the following operations.</p> <ul style="list-style-type: none"> • Write-per-bit • Flash write • \overline{CAS} before \overline{RAS} refresh • Split data transfer
\overline{CAS} (Column address strobe)		<p>This signal latches the column addresses (A0 to A8), selects the digit line connecting the sense amplifier, and activates the output circuit which outputs data to the random access port.</p> <p>It also serves as the signal which selects the following operations.</p> <ul style="list-style-type: none"> • Read/write • Block write • Color register set • Mask register set
A0 to A8 (Address inputs)		<p>These are the address input pins, TAP register input pins, and STOP register input pins.</p> <p>Address Input This is a 9-bit address bus. It inputs a total of 18 bits of the address signal, starting from the upper 9 bits (row address) and then followed by the lower 9 bits (column bits) (address multiplex method). Using these, one word memory cells (8 bits) are selected from the 262,144 words × 8 bits memory cell array.</p> <p>During use, specify the row address, activate the \overline{RAS} signal, latch the row address, switch to the column address, and activate the \overline{CAS} signal. After activating the \overline{RAS} and \overline{CAS} signals, each address signal is taken into the device. For this reason, the address input setup time (t_{ASR}, t_{ASC}) and hold time (t_{RAH}, t_{CAH}) are specified for activating the \overline{RAS} and \overline{CAS} signals.</p> <p>TAP Register Input In the data transfer cycle, this TAP register input pin functions as the address input pin which selects the memory cell for transferring (9 bits are latched at the falling edge of \overline{RAS}) and the TAP register data input pin which specifies the start addresses of the serial read/write operation after data transfer (9 bits are latched at the falling edge of the \overline{CAS}).</p> <p>STOP Register Input This pin functions as the STOP register input pin when the STOP register is set (STOP register data (9 bits) are latched at the falling edge of the \overline{RAS}).</p>

Pin Name	Input/ Output	Function
$\overline{DT}/\overline{OE}$ (Data transfer/ output enable)	Input	These are the data transfer control signal and read operation control signal respectively. They have different functions in the data transfer cycle and read cycle. Data transfer control signal (In data transfer cycle) The data transfer cycle is initiated when a low level is input to this pin at the falling edge of \overline{RAS} . Read operations control signal (In read cycle) Read operation is performed when this signal, and the \overline{RAS} and \overline{CAS} signals are activated. The input/output pin is high impedance when this signal is not activated. When the $\overline{WB}/\overline{WE}$ signal is activated while the $\overline{DT}/\overline{OE}$ signal is activated, the $\overline{DT}/\overline{OE}$ signal is invalid in the memory and read operations cannot be performed.
$\overline{WB}/\overline{WE}$ (Write-per-bit/ Write enable)		These are the write operation control signal and mask write cycle (write-per-bit function) mask data input control signal, respectively. When this signal, \overline{RAS} and \overline{CAS} signals are activated, write operations or mask write can be performed. These mode are determined by the level of $\overline{WB}/\overline{WE}$ at the falling edge of \overline{RAS} . <ul style="list-style-type: none"> • High level 8-bit write cycle • Low level Mask write cycle (Write-per-bit)
DSF (Special function enable)		This signal controls the selection of functions. The selection of functions is determined by the level of this signal at the falling edge of the \overline{RAS} and \overline{CAS} . The functions will change as follows when this signal is high level. <ul style="list-style-type: none"> • The data transfer cycle changes to a split data transfer cycle. • The read/write cycle of each \overline{RAS} clock changes to the flash write cycle. • The write cycle of each \overline{CAS} clock changes to the block write cycle.
W0 to W7/I00 to I07 (Mask data selects/ Data inputs, outputs)	Input/ Output	These are normally 8-bit data bus and are used for inputting and outputting data. (I00 to I07). Function as the mask data input pins (W0 to W7) in the mask write cycle (write-per-bit function). Write operations can be performed only for W0 to W7 that are input with a high level at the falling edge of \overline{RAS} (new mask data). Functions as the column selection data input pin in the block write cycle.

(3/3)

Pin Name	Input/ Output	Function
SC (Serial clock)	Input	<p>This pin inputs the clock which controls the serial access port operation.</p> <p>Serial Read The data of the data register which is synchronized with the rising edge of the SC are output from the SIO0 to SIO7 pins and kept until the next SC rising edge.</p> <p>Serial Write The data from the SIO0 to SIO7 pins are latched at the rising edge of the SC and written in the data register.</p>
\overline{SE} (Serial data input/ output enable)		<p>This is a control pin for the serial access port input/output buffer. It controls data output during serial reading and controls data input during serial writing.</p> <p>By inputting the serial clock, the serial pointer will operate even if \overline{SE} has not been activated (high level input).</p>
SIO0 to SIO7 (Serial data inputs/ outputs)	Input/ Output	<p>These are the serial data input and output pins of the serial access port.</p>
QSF (Special function output)	Output	<p>This is a position discrimination pin of the serial pointer (upper side or lower side).</p> <p>Which side is being serial accessed (upper side or lower side) can be discriminated according to the output of this pin.</p> <ul style="list-style-type: none"> • High level Upper side (Addresses 256 to 511) • Low level Lower side (Addresses 0 to 255)

2. Random Access Port Operations

The operation mode is determined by the $\overline{\text{CAS}}$, $\overline{\text{DT/OE}}$, $\overline{\text{WB/WE}}$, and DSF level at the falling edge of $\overline{\text{RAS}}$ and DSF level at the falling edge of $\overline{\text{CAS}}$.

Table 2-1. Operation Mode

$\overline{\text{RAS}}$ Falling Edge				$\overline{\text{CAS}}$ Falling Edge	Operation Mode	
CAS	$\overline{\text{DT/OE}}$	$\overline{\text{WB/WE}}$	DSF	DSF		
H	H	x	L	x	Read/Write Cycle	Read cycle
H	H	H	L	L		Write cycle
H	H	H	L	H		Block write cycle
H	H	L	L	L		Mask write cycle (New mask/Old mask) ^{Note 1}
H	H	L	L	H		Block mask write cycle (New mask/Old mask) ^{Note 1}
H	H	H	H	H		Color register set cycle
H	H	H	H	L		Write mask register set cycle
H	H	L	H	x		Flash write cycle (New mask/Old mask) ^{Note 1}
H	L	H	L	x	Data Transfer Cycle	Single read data transfer cycle
H	L	H	H	x		Split read data transfer cycle
H	L	L	L	x		Single write data transfer cycle (New mask/Old mask) ^{Note 1}
H	L	L	H	x		Split write data transfer cycle (New mask/Old mask) ^{Note 1}
L	x	x	L	x	Refresh Cycle	$\overline{\text{CAS}}$ before $\overline{\text{RAS}}$ refresh cycle (Option reset) ^{Note 1, 2}
L	x	H	H	x		$\overline{\text{CAS}}$ before $\overline{\text{RAS}}$ refresh cycle (No reset)
L	x	L	H	x		$\overline{\text{CAS}}$ before $\overline{\text{RAS}}$ refresh cycle (STOP register set) ^{Note 2}
H	H	x	L	x		$\overline{\text{RAS}}$ only refresh cycle

Notes 1. Observe the following conditions when using the new mask data or old mask data in these cycles.

(1) Old mask data

Can be used after setting the mask data using the write mask register set cycle.

(2) New mask data

Can be used after setting the mask data using the $\overline{\text{CAS}}$ before $\overline{\text{RAS}}$ refresh cycle (Option reset cycle).

2. The STOP register is set to "FFH (11111111)" by the optional reset cycle.

Remark H : High level, L : Low level, x : High level or low level

2.1 Random Read Cycle

This product has a common 8-bit input/output pin. To output data, specify the address using the $\overline{\text{RAS}}$ and $\overline{\text{CAS}}$ clocks and then set $\overline{\text{DT}}/\overline{\text{OE}}$ to low level.

The data output will be kept until one of the following conditions is set.

- (1) Set $\overline{\text{RAS}}$ and $\overline{\text{CAS}}$ to high level
- (2) Set $\overline{\text{DT}}/\overline{\text{OE}}$ to high level
- (3) Set $\overline{\text{WB}}/\overline{\text{WE}}$ to low level

The read cycle and data transfer cycle are differentiated according to the level of $\overline{\text{DT}}/\overline{\text{OE}}$ at the falling edge of the $\overline{\text{RAS}}$ clock. If $\overline{\text{DT}}/\overline{\text{OE}}$ is set to low level at the falling edge of the $\overline{\text{RAS}}$ clock, data transfer cycle operations will be initiated. Therefore, to set the read cycle, input a high level above t_{DHH} (MIN.) to $\overline{\text{DT}}/\overline{\text{OE}}$ from the falling edge of the $\overline{\text{RAS}}$ clock, and then input a low level.

Caution Set the DSF to low level at the falling edge of $\overline{\text{RAS}}$. If set to high level, the memory cell data cannot be output.

2.1.1 Extended Read Data Output (μPD482235)

The μPD482235 adopt the hyper page mode cycle which is a faster read/write cycle than the fast page mode of the μPD482234 (Hyper page mode cycle time: 30 ns (MIN.)).

With this cycle, the read data output can be kept until the next $\overline{\text{CAS}}$ cycle, and because the output is extended, the minimum cycle can easily be used. For example, by fixing $\overline{\text{DT}}/\overline{\text{OE}}$ at low level after dropping $\overline{\text{RAS}}$ and executing the hyper page read cycle, each time the column address is latched at the falling edge of $\overline{\text{CAS}}$, the data output will be updated and kept until the next falling edge of $\overline{\text{CAS}}$. As a result, the output will be extended only during $\overline{\text{CAS}}$ precharge time (t_{CP}) as compared to the normal fast page mode.

Figure 2-1. Extended Data Output of Hyper Page Mode

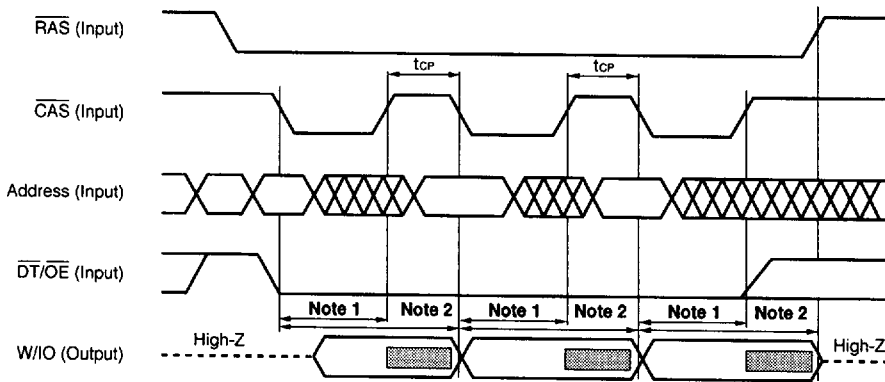

- Notes**
- 1. Time during which the output data is kept in the fast page read cycle.
 - 2. Time during which the output data is kept in the hyper page read cycle (part: Extended data output).

2.2 Random Write Cycle (Early Write, Late Write)

There are three types of random write cycles—the early write and late write. To use these cycles, activate the $\overline{\text{RAS}}$ and $\overline{\text{CAS}}$ clocks and set $\overline{\text{WB/WE}}$ to low level.

The $\overline{\text{WB/WE}}$ also controls the mask data for the write-per-bit function (mask write cycle). Therefore, when performing the normal write cycle which does not use the write-per-bit function, set this pin to high level at the falling edge of the $\overline{\text{RAS}}$ clock.

2.2.1 Early Write Cycle

The early write cycle controls data writing according to the $\overline{\text{CAS}}$ clock.

To execute this cycle, set $\overline{\text{WB/WE}}$ to low level earlier than the $\overline{\text{CAS}}$ clock. The write data is taken into the device at the falling edge of the $\overline{\text{CAS}}$ clock.

2.2.2 Late Write Cycle

The late write cycle controls data writing according to the $\overline{\text{WE}}$ clock.

To execute this cycle, set $\overline{\text{WB/WE}}$ to low level later than the $\overline{\text{CAS}}$ clock. The write data is taken into the device at the falling edge of $\overline{\text{WB/WE}}$. To set the output to high impedance at this time, keep $\overline{\text{DT/OE}}$ at high level until $\overline{\text{WB/WE}}$ is input.

2.3 Read Modify Write Cycle

The read modify write cycle performs data reading and writing in one $\overline{\text{RAS}}$ and $\overline{\text{CAS}}$ cycle.

To execute this cycle, delay $\overline{\text{WB/WE}}$ from the late write cycle by t_{rw0} (MIN.), t_{cwb} (MIN.), and t_{aw0} (MIN.). Follow the t_{oez} and t_{oeD} specifications so that the output data and input data do not clash in the data bus. The data after modification can be input after more than t_{oeD} (MIN.) from the rising edge of $\overline{\text{DT/OE}}$.

2.4 Fast Page Mode Cycle (μ PD482234)

The μ PD482234 adopt the fast page mode. This mode accesses memory cells in the same row array in about 1/3 of the time taken by the normal random read/write cycle. This fast page mode cycle is executed by repeating the $\overline{\text{CAS}}$ clock cycle more than two times while the $\overline{\text{RAS}}$ clock is being activated. In this mode read, write and read modify write cycles are available for each of the consecutive $\overline{\text{CAS}}$ cycles within the same $\overline{\text{RAS}}$ cycle.

2.5 Hyper Page Mode Cycle (μ PD482235)

The μ PD482235 adopt a hyper page mode cycle which is a faster read/write cycle than the fast page mode of the μ PD482234 (Hyper page mode cycle time: 30 ns (MIN.)).

In this cycle, because the read data output is kept until the following $\overline{\text{CAS}}$ cycle and as a result, the output is extended, the minimum cycle can easily be used. The output is extended compared to the normal fast page mode of μ PD482234. Refer to 2.1.1 **Extended Read Data Output**.

2.5.1 Setting the Output to the High Impedance State

The hyper page mode can use one of three methods of setting the output pin to the high impedance state depending on the version; these methods are $\overline{\text{WE}}$ control and $\overline{\text{OE}}$ control (latched control).

(1) \overline{WE} control

After a high level is input to \overline{CAS} , when a pulse conforming to the t_{we} specification is supplied to the \overline{WE} pin (\overline{WE} = enable) during the same \overline{CAS} cycle, the W/I/O pin is held in the high impedance state until the next \overline{CAS} cycle.

Figure 2-2. \overline{WE} Control Output Control

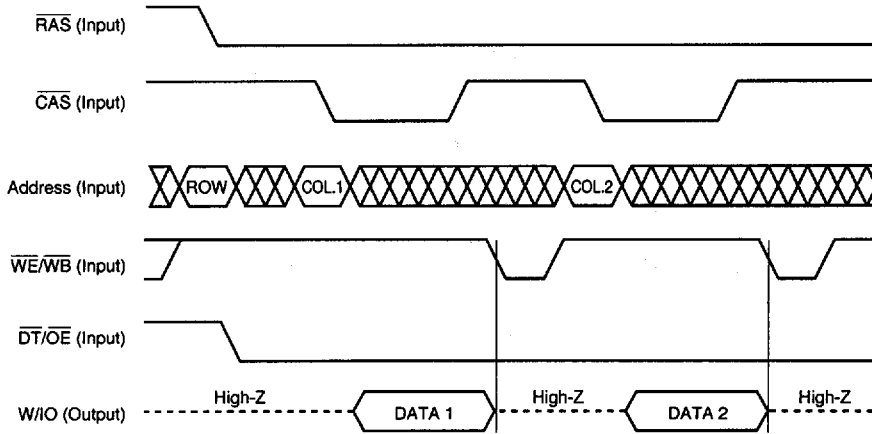

(2) \overline{OE} control (latched control)

After a high level is input to \overline{CAS} , when a high level is supplied to the \overline{OE} pin (\overline{OE} = disable) during the same \overline{CAS} cycle, the W/I/O pin is held in the high impedance state until the next \overline{CAS} cycle. This specification enables efficient use of \overline{OE} interleaving during parallel connection.

Figure 2-3. \overline{OE} Control Output Control (Latched Control)

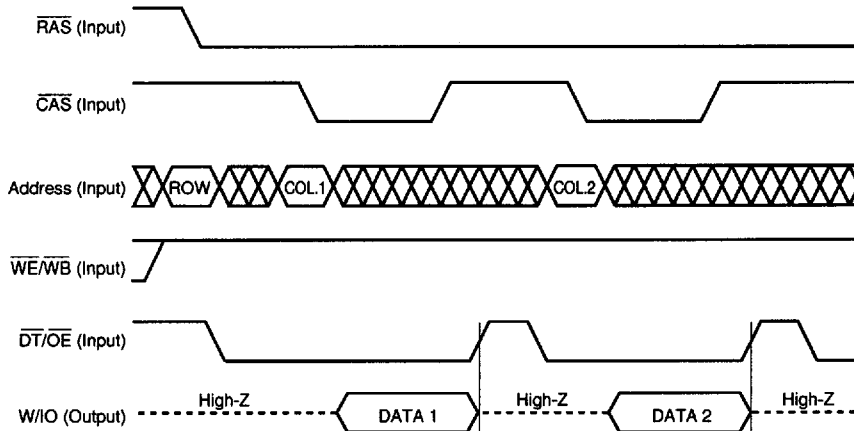

2.6 Flash Write Cycle

This cycle writes the color register data in a 4,096-bit memory cell in one cycle. The memory cell range for one flash write cycle is 512 columns on the same row address (512-column × 8 · IO = 4,096 bits).

2.6.1 Execution of Flash Write Cycle

To execute the flash write cycle, set $\overline{WB/WE}$ to low level at the falling edge of \overline{RAS} .

By using the write-per-bit function (new mask data/old mask data), only the required W/IO can be selected and written.

Figure 2-4. Memory Cell Range That Can be Written with Flash Write Cycle

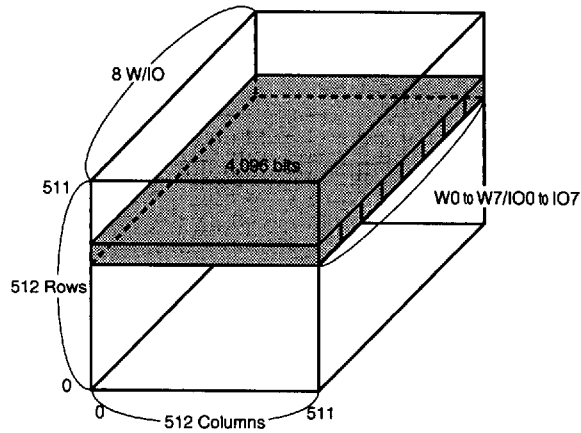

Remark  is the memory cell range that can be written in one flash write cycle.

2.7 Block Write Cycle

This cycle writes the color register data in 32-bit memory cell in one cycle. The memory cell range in which data can be written in one block write cycle is four continuous columns on one row address (4-column × 8 · IO = 32 bits).

Any column of the four columns can be selected and writing prohibited. Determine whether to write or prohibit writing according to the data selected for column.

2.7.1 Free Column Selection

Determine which column to select according to the W/IO pin to which the data selected for the column is to be input.

The four columns (1st to 4th) correspond to W0 to W3/IO0 to IO3 to which the data selected for column will be input (The following table shows the 1st to 4th columns specified by A0 and A1 and the corresponding W/IO pins to which the data selected will be input.).

2.7.2 Column Select Data

Input column select data for every four columns at the 32 bits (4-column × 8 · IO). The data will be written if the column select data is "1". Writing will be prohibited if the column select data is "0".

2.7.3 Execution of Block Write Cycle

At the falling edge of the slowest signal (\overline{CAS} , $\overline{WB/WE}$), input the "1" column select data or "0" column select data to W0 to W3/IO0 to IO3 corresponding to columns 1st to 4th.

By using the write-per-bit (new mask data/old mask data) function, only the required W/IO can be selected and written.

Table 2-2. I/O Pins Input with Column Select Data Corresponding to Columns 1st to 4th

Selected 4 Columns	Column Address and Corresponding W/IO Pin			Column Select Data	Writing
	A1	A0	IO		
1st column	0	0	IO0	1	Yes
				0	No
2nd column	0	1	IO1	1	Yes
				0	No
3rd column	1	0	IO2	1	Yes
				0	No
4th column	1	1	IO3	1	Yes
				0	No

Figure 2-5. Memory Cell Range That Can be Written in Block Write Cycle

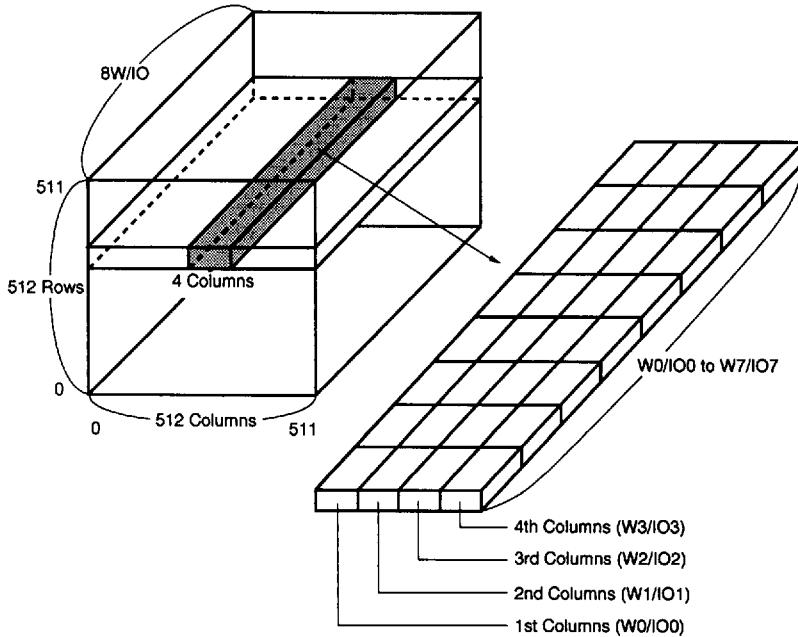

- Remarks**
1. is the memory cell range that can be written in one block write cycle.
 2. () is the W/I/O pin input with the column select data.

2.8 Register Set Cycle (Color Register, Write Mask Register)

This cycle writes data in the color register and write mask register. To execute the register set cycle, set \overline{CAS} , $\overline{DT/OE}$, $\overline{WB/WE}$ and DSF to high level at the falling edge of \overline{RAS} . Determine which register to select according to the DSF level at the falling edge of \overline{CAS} .

The register set cycle also serves as the \overline{RAS} only refresh cycle.

Table 2-3. Register Selection

DSF level at \overline{CAS} falling edge	Selected register
High level	Color register
Low level	Write mask register

Caution After selecting the write mask register and writing the mask data, the write-per-bit function in the mask write cycle will be set for the old mask register. Refer to 2.9.1 Write-Per-Bit Function.

2.9 Mask Write Cycle

Cycles that use the write-per-bit function during the random write cycle, flash write cycle, block write cycle, write data transfer cycle, are called mask write cycles. In the fast page/hyper page mode write cycle, the mask data cannot be changed during the $\overline{\text{CAS}}$ cycle.

2.9.1 Write-Per-Bit Function

The write-per-bit function writes data using the mask data only in the required IO-pin. It writes when the mask data is "1" and prohibits writing when the data is "0".

Table 2-4. Mask Data Selection

W Pin	Mask Data	Writing
W0 to W7	1	Yes
	0	No

2.9.2 Selecting Mask Data

There are two ways of selecting mask data. One is the new mask data method and the other is the old mask data method.

With the new mask data method, new mask data is set in the cycle writing. With the old mask data, mask data set in the write mask register is used.

(1) New Mask Data Method

This method is usable in all versions.

To switch to the mode using new mask data, set the DSF to low level at the falling edge of $\overline{\text{CAS}}$ in the $\overline{\text{CAS}}$ before $\overline{\text{RAS}}$ refresh cycle.

As a result, the write-per-bit function can be used using the old mask data from the next mask write cycle.

(2) Old Mask Data Method

To switch to the mode using old mask data, set the DSF to low level at the falling edge of $\overline{\text{CAS}}$ in the write mask register set cycle, and write the mask data in the write mask register.

As a result, the write-per-bit function can be used using the old mask data from the next mask write cycle.

2.9.3 Execution of Mask Write Cycle

To execute the write-per-bit function, select the new mask data method or old mask data method, and set $\overline{\text{WB}}/\overline{\text{WE}}$ to low level at the falling edge of $\overline{\text{RAS}}$ of each write cycle. At this time, input the mask data to the W pin in the write cycle using the new mask data. In the write cycle using the old mask data, as the mask data set to the write mask register will be used, there is no need to input the mask data to the W pin.

This function is valid only at the falling edge of $\overline{\text{RAS}}$. In the fast page/hyper page mode write cycle, the mask data determined in the first $\overline{\text{RAS}}$ cycle for moving onto the next fast page/hyper page mode will be valid while the fast page/hyper page mode write cycle continues.

2.10 Refresh Cycle

The refresh cycle of this product consists of the $\overline{\text{CAS}}$ before $\overline{\text{RAS}}$ refresh cycle and refresh cycle using external address inputs ($\overline{\text{RAS}}$ only refresh and read/write refresh). The refresh period is the same as the DRAM (Standard), 512 cycles/8 ms.

2.10.1 Refresh Cycle Using External Address Input ($\overline{\text{RAS}}$ Only Refresh and Read/Write Refresh)

By specifying the row address using the 9 bits between A0 to A8 at the falling edge of $\overline{\text{RAS}}$, setting $\overline{\text{CAS}}$ and $\overline{\text{DT/OE}}$ to high level, and keeping $\overline{\text{CAS}}$ at high level while $\overline{\text{RAS}}$ is low level, the memory cells on the specified row address (512×8 bits) can be refreshed. At this time, refresh is executed, W0 to W7/IO0 to IO7 pins are kept at high impedance, and information such as memory contents, register data, function settings, etc. are all also kept.

At the falling edge of $\overline{\text{RAS}}$, all cycles whose $\overline{\text{CAS}}$ are high level input the external address. Therefore, in addition to the read/write cycle operations, etc. refresh operations similar to the $\overline{\text{RAS}}$ only refresh operations will be performed. For this reason, in systems in which addresses in the memory are always increased or decreased, it may not be necessary to perform refresh again.

When several devices exist on one bus, data will clash in the bus during the above read/write operations unless each device is equipped with a buffer. Consequently, as it is necessary to set the I/O line to high impedance beforehand during refresh, normally the $\overline{\text{RAS}}$ only refresh operation is used.

2.10.2 $\overline{\text{CAS}}$ Before $\overline{\text{RAS}}$ Refresh Cycle (Including Hidden Refresh)

When $\overline{\text{CAS}}$ is set to low level at the falling edge of $\overline{\text{RAS}}$, the refresh address is supplied from the internal refresh address counter. The internal refresh address counter is increased automatically each time this refresh cycle is executed.

During this refresh cycle, functions of random access port and serial access port are selected as follows according to the DSF and $\overline{\text{WB/WE}}$ levels at the falling edge of $\overline{\text{RAS}}$.

(1) When DSF is low level: Optional reset

All STOP register data become "1" and the mask write cycle switches to the new mask data method.

(2) When DSF is high level and $\overline{\text{WB/WE}}$ is low level: STOP register set

The STOP register data is input from the A0 to A7 pins at the falling edge of $\overline{\text{RAS}}$.

(3) When DSF, $\overline{\text{WB/WE}}$ is high level: No reset

Only refresh operations are performed and the function selection state is kept.

In all cases, the W/IO pin is kept at high impedance. When $\overline{\text{CAS}}$ and $\overline{\text{DT/OE}}$ are kept low level while the mode is changed to the $\overline{\text{CAS}}$ before $\overline{\text{RAS}}$ refresh cycle following the read cycle, and $\overline{\text{RAS}}$ is activated, the hidden refresh cycle will be initiated. In this cycle, the W/IO pin does not become high impedance and the data read in the former read cycle will be kept as it is.

Because internal memory operations are equivalent to $\overline{\text{CAS}}$ before $\overline{\text{RAS}}$ refresh, no external addresses are required.

Like $\overline{\text{CAS}}$ before $\overline{\text{RAS}}$ refresh, in the hidden cycle, functions will be selected according to the level of DSF, $\overline{\text{WB/WE}}$ at the falling edge of $\overline{\text{RAS}}$. Operations are guaranteed when DSF is low level and when DSF, $\overline{\text{WB/WE}}$ are high level.

3. Serial Access Port Operations

There are two types of data transfer cycles—data transfer from the random access port to the serial access port (read data transfer) and data transfer from the serial access port to the random access port (write data transfer). There are also two types of data transfer methods—single data transfer and split data transfer.

To set the data transfer cycle, input high level to \overline{CAS} and input low level to $\overline{DT/OE}$ at the falling edge of \overline{RAS} . The data transfer type differs according to the input levels of $\overline{WB/WE}$, and \overline{DSF} at the falling edge of \overline{RAS} .

Table 3-1. Serial Access Port Operation Mode

At \overline{RAS} Falling Edge				Data Transfer Type	Transfer Direction	
\overline{CAS}	$\overline{DT/OE}$	$\overline{WB/WE}$	\overline{DSF}		Transfer Source	Transfer Destination
H	L	H	L	Single read data transfer	Random access port	Serial access port
H	L	H	H	Split read data transfer		
H	L	L	L	Single mask write data transfer ^{Note}	Serial access port	Random access port
H	L	L	H	Split mask write data transfer ^{Note}		

Note Write-per-bit function can be specified.

Remark H: High level, L: Low level

3.1 Single Data Transfer Method

With this method, 512 words \times 8 bits (whole memory range of serial access port) data is transferred at one time. This method can be used in both write data transfer and read data transfer.

3.1.1 Single Read Data Transfer Cycle

This cycle transfers the 4K-bit (512 words \times 8 bits) data of the random access port to the serial access port in one cycle.

(a) Setting of Single Read Data Transfer Cycle

To set the data transfer cycle, input a high level to $\overline{\text{CAS}}$ and $\overline{\text{WB/WE}}$ and low level to $\overline{\text{DT/OE}}$ and DSF at the falling edge of $\overline{\text{RAS}}$.

Using the row address input to A0 to A8 at the falling edge of $\overline{\text{RAS}}$, the memory cells (512 words \times 8 bits) of the transfer source of the random access port can be selected. The address data input to A0 to A8 at the falling edge of $\overline{\text{CAS}}$ will be latched as the TAP register data of serial access port. Refer to 3.4 TAP Register.

(b) Execution of Single Read Data Transfer Cycle

To execute the data transfer cycle, set the single read data transfer cycle and then input a high level to $\overline{\text{DT/OE}}$ and $\overline{\text{RAS}}$.

When SC is active (edge control), data transfer will be executed at the rising edge of $\overline{\text{DT/OE}}$. When SC is inactive (self control), it will be executed at the rising edge of $\overline{\text{RAS}}$. At the same time, the serial address pointer jumps to the start column (TAP) of the next serial read cycle, and the TAP register will be set the empty state.

After the transfer is completed, the new serial access port data is output after t_{SCA} following the rise of the SC clock that occurs after t_{SDH} if the SC is active, and after t_{SDH} if SC is inactive.

Caution When the single read data transfer cycle is executed while the serial access port is performing serial write operations, the serial access port will start serial read operations at the rising edge of $\overline{\text{RAS}}$. Refer to 4. Electrical Characteristics Read Data Transfer Cycle (Serial Write \rightarrow Serial Read Switching) Timings.

3.1.2 Single Mask Write Data Transfer Cycle

This cycle transfers 4K-bit (512 words × 8 bits) data of the serial access port to the random access port in one cycle. Because $\overline{WB/WE}$ is low level at the falling edge of \overline{RAS} , the write-per-bit function always functions in this transfer cycle. Refer to 2.9 Mask Write Cycle.

(a) Setting of Single Mask Write Data Transfer Cycle

To set this cycle, latch the data to be transferred to the serial access port, and then input a high level to \overline{CAS} and low level to $\overline{DT/OE}$, $\overline{WB/WE}$, and DSF at the falling edge of \overline{RAS} . Because the write-per-bit function functions in this transfer operation, for the new mask data method, the mask data must be supplied to $W0$ to $W7$ at the falling edge of \overline{RAS} , and for the old mask data method, there is no need to control the mask data.

The memory cells (512 words × 8 bits) of the transfer destination of the random access port are selected using the row address input to $A0$ to $A8$ at the falling edge of \overline{RAS} . The address data input to $A0$ to $A8$ at the falling edge of \overline{CAS} is input as the TAP register data of serial access port. Refer to 3.4 TAP Register.

(b) Execution of Single Mask Write Data Transfer Cycle

To execute this cycle, set the single write data transfer cycle and then input high level to \overline{RAS} . Data will be transferred at the rising edge of \overline{RAS} . At the same time, the serial address pointer jumps to the start column (TAP) of the next serial write cycle, and the TAP register will be set the empty state.

After the transfer is completed, the new serial access port data is latched at the rising edge of the SC clock that occurs after t_{SDHR} .

Caution 1. When the single mask write data transfer cycle is executed while the serial access port is performing serial read operations, the serial access port will start serial write operations at the rising edge of \overline{RAS} . Refer to 4. Electrical Characteristics Write Data Transfer Cycle (Serial Read → Serial Write Switching) Timings.

2. Always make \overline{CAS} low level in the write data transfer cycle and latch TAP. If write data transfer is performed without setting TAP, serial access port operations cannot be ensured until either one of the following points. If the SC clock is input during this time, the serial register value also cannot be guaranteed.

- Until the falling edge of $\overline{C.S}$ during the write data transfer cycle
- Until the read data transfer cycle is executed again

Figure 3-1. Single Write Data Transfer and TAP Operation

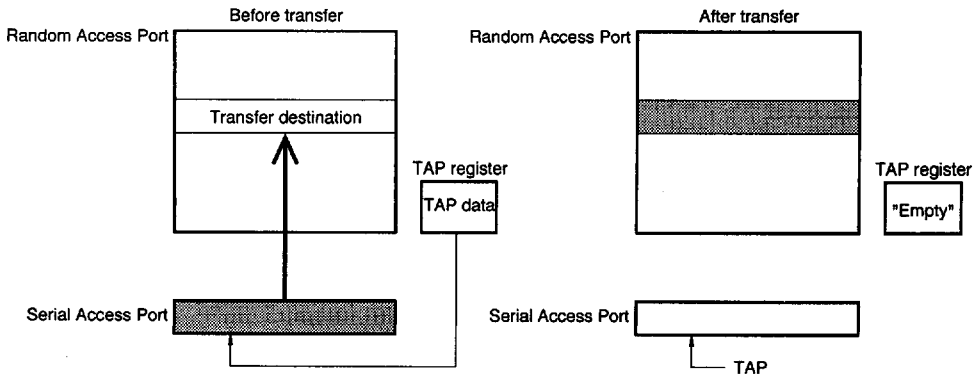

3.2 Split Data Transfer Method

With this method, the 512 words \times 8 bits (whole memory range of serial access port) data is divided into the lower column (0 to 255) and upper column (256 to 511), each consisting of 256 words \times 8 bits.

Because the columns are divided into upper and lower columns with this method, data transfer can be performed on lower column (or upper column) while performing read/write operations in the upper column (or lower column). For this reason, transfer timing design is easy. This transfer method can be used in both write data transfer and read data transfer.

3.2.1 Split Read Data Transfer Cycle

This cycle divides the 4K-bit (512 words \times 8 bits) data of the random access port into the lower and upper columns and transfers them to the serial access port.

In this cycle, the serial read/write can be performed in the columns to which data is not transfer.

(a) Setting of Split Read Data Transfer Cycle

To set this cycle, input a high level to $\overline{\text{CAS}}$, $\overline{\text{WB/WE}}$ and DSF, and low level to $\overline{\text{DT/OE}}$ at the falling edge of $\overline{\text{RAS}}$.

The memory cells (512 words \times 8 bits) of the transfer source of the random access port are selected using the row address input to A0 to A8 at the falling edge of $\overline{\text{RAS}}$. And the address data input to A0 to A7 at the falling edge of $\overline{\text{CAS}}$ is latched as the TAP register data of serial access port. Refer to **3.4 TAP Register**. There is no need to control address data input to A8).

(b) Execution of Split Read Data Transfer Cycle

To execute this cycle, set the split read data transfer cycle and then input the high level to $\overline{\text{RAS}}$. Data will be transferred at the rising edge of $\overline{\text{RAS}}$. Data is transferred from the random access port to the serial access port automatically at the column side (Column not pointed to by the serial address pointer) where serial access port is inactive. To confirm the transferred column side, check the output state of the QSF pin. Refer to **3.3.3 QSF Pin Output**.

When the serial address pointer comes to the jump source address specified by the STOP register, the serial address pointer jumps to the start column (TAP) of the serial read/write cycle at the inactive column side, and the TAP register will be set the empty state.

3.2.2 Split Mask Write Data Transfer Cycle

This cycle divides the 4K-bit (512 words \times 8 bits) data of the serial access port into the lower and upper columns and transfers them to the random access port.

In this cycle, serial read/write can be performed for columns to which data is not transferred.

Because $\overline{WB/WE}$ is low level at the falling edge of \overline{RAS} , the write-per-bit function always functions in this transfer cycle. Refer to **2.9 Mask Write Cycle**.

(a) Setting of Split Mask Write Data Transfer Cycle

To set this data transfer cycle, input a high level to \overline{CAS} and DSF and low level to $\overline{DT/OE}$, $\overline{WB/WE}$ at the falling edge of \overline{RAS} . Because the write-per-bit function functions in this transfer operation, for the new mask data method, the mask data must be supplied to W0 to W7 at the falling edge of \overline{RAS} , and for the old mask data method, there is no need to control the mask data.

The memory cells (512 words \times 8 bits) of the transfer destination of the random access port are selected using the row address input to A0 to A8 at the falling edge of \overline{RAS} . The address data input to A0 to A7 at the falling edge of \overline{CAS} is input as the TAP register data. Refer to **3.4 TAP Register**. There is no need to control address data input to A8.

(b) Execution of Split Mask Write Data Transfer Cycle

To execute this cycle, set the split write data transfer cycle and then input high level to \overline{RAS} . Data will be transferred at the rising edge of \overline{RAS} . Data is transferred from the serial access port to the random access port automatically at the column side (Column not pointed to by the serial address pointer) where the serial access port is inactive. To confirm the transferred column side, check the output state of the QSF pin. Refer to **3.3.3 QSF Pin Output**.

When the serial address pointer comes to the jump source address specified by the STOP register, the serial address pointer jumps to the start column (TAP) of the serial read/write cycle at the inactive column side, and the TAP register will be set the empty state.

Figure 3-2. Split Mask Write Data Transfer and TAP Operations

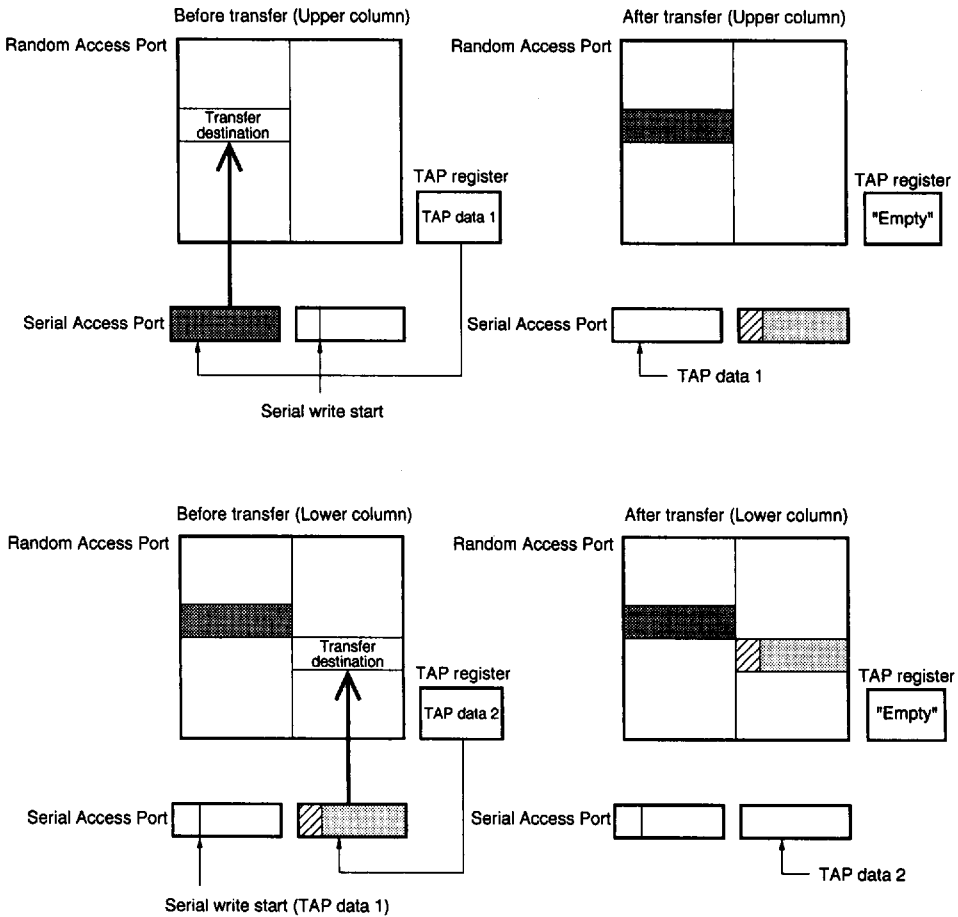

3.3 Serial Read/Write

The serial access port (512 words × 8 bits) is independent from the random access port and can perform read and write operations. The serial access port performing single data transfer and split data transfer can not perform read and write operations independently.

Caution When the power is turned on, the serial access port sets into the Input (write) mode and the SIO pin is the high impedance state.

3.3.1 Serial Read Cycle

To set the serial read cycle, perform the single read data transfer cycle (The mode will not change in the split read data transfer cycle.).

Execute the single read data transfer cycle and latch the data and TAP data. By inputting a clock signal to the SC pin and inputting a low level to the \overline{SE} pin, data will be output from the serial address pointer specified by TAP register. The data synchronizes with the rising edge of the SC clock and is output from the SIO0 to SIO7 pin, and the data is kept until the next rising edge of the SC clock.

(a) Reading-Jump

The \overline{SE} pin controls the SIO pin output buffer independently from the SC clock. By setting the \overline{SE} pin to high level even while inputting the SC clock, SIO0 to SIO7 pins become high impedance. But the operations of serial address pointer will be continued while the SC clock is being input even though reading has been prohibited from \overline{SE} pin. Reading-jump of the column can be performed using this function.

3.3.2 Serial Write Cycle

To set the serial write cycle, perform the single write data transfer cycle (The mode will not change in the split write data transfer cycle.). To prevent the transfer data from being written in the memory cell of the random access port, set all bits of the mask data to "0" and control the mask data.

Execute the single write data transfer cycle and set the serial write cycle. By inputting the clock signal to the SC pin and inputting a low level to the \overline{SE} pin, data can be latched from the serial address pointer specified by TAP register. The data synchronizes with the rising edge of the SC clock and is input from SIO0 to SIO7 pins. Be sure to follow the specifications for the setup time (t_{SE}) and hold time (t_{SEH}) of \overline{SE} pin for the SC clock.

(a) Writing-Jumps (Intermittent Writing)

The \overline{SE} pin controls writing operations independently from the SC clock. By setting the \overline{SE} pin to high level even while inputting the SC clock, writing will not be executed. But the operations of serial address pointer will be continued while the SC clock is being input even though writing has been prohibited from \overline{SE} pin. These functions enable writing-jumps (intermittent writing) to be performed. The masked data is kept as the old data.

3.3.3 QSF Pin Output

QSF pin determines whether the serial address pointer is at the upper column side (addresses 256 to 511) or the lower column side (addresses 0 to 255) at the rising edge of the following SC clock during serial read or write. In other words, it outputs the uppermost bit (A8) of the column address of the serial address pointer.

During split data transfer cycle, data is transferred at the column side where serial access port is inactive. The following table shows the QSF pin output state and the access pointer of following SC clocks.

QSF Output	Access Address of Following SC clock	Transfer Destination (Split Data Transfer Method)
Low level	Addresses 0 to 255	Addresses 256 to 511
High level	Addresses 256 to 511	Addresses 0 to 255

3.4 TAP (Top Access Point) Register

The TAP register is a data register which specifies the start address (first serial address point = TAP) of the serial read or serial write.

Set data to this register each time a transfer cycle is executed.

3.4.1 Setting of TAP Register

The data input to A0 to A8 (A0 to A7: Split data transfer) at the falling edge of $\overline{\text{CAS}}$ during the setting of a transfer cycle is set as the TAP register data. By executing the transfer cycle, the start address of the following serial read (or write) operations is specified by the data of the TAP register and the TAP register will be kept in the empty state until the TAP register is set again.

In the split data transfer cycle, because the inactive serial access port column addresses are specified by the data of the TAP register automatically, there is no need to control the A8 data.

Caution When the TAP register is empty, the address following the 511 serial address point will be 0. In addition, because the serial address pointer will not jump to the column specified by the STOP register, the binary boundary jump function cannot be used. Refer to 3.6 Binary Boundary Jump Function.

3.5 STOP Register

The STOP register is a data register which determines the column of the jump source when jumping to a different column side (lower column or upper column) in the split data transfer cycle. Five types of columns can be selected for starting jump (jumping is possible at 2, 4, 8, 16, and 32 points). The following table shows the correspondence between the column at the jump source and data of the STOP register.

Once set, the STOP register data is kept until it is set again.

3.5.1 Setting of STOP Register

To set the STOP register, set $\overline{\text{WB}}/\overline{\text{WE}}$ to low level at the falling edge of $\overline{\text{RAS}}$ in the $\overline{\text{CAS}}$ before $\overline{\text{RAS}}$ refresh cycle. The data input to A0 to A7 will be input as the STOP register data.

Table 3-2. STOP Register Data and Jump Source Column

STOP Register Data					Division	Bit Width	Jump Source Bit Column (Decimal Number)
A7	A6	A5	A4	A3 to A0			
1	1	1	1	1	1/2	256	255 511
0	1	1	1	1	1/4	128	127, 255 383, 511
0	0	1	1	1	1/8	64	63, 127, 191, 255 319, 383, 447, 511
0	0	0	1	1	1/16	32	31, 63, 95, 127, 159, 191, 223, 255 287, 319, 351, 383, 415, 447, 479, 511
0	0	0	0	1	1/32	16	15, 31, 47, 63, 79, 95, 111, 127, 143, 159, 175, 191, 207, 223, 239, 255 271, 287, 303, 319, 335, 351, 367, 383, 399, 415, 431, 447, 463, 479, 495, 511

Remark A8: Don't care.

Caution. When the power is supplied, all STOP register data will be undefined.

3.6 Binary Boundary Jump Function

This function causes the serial address pointer jump to the TAP specified by the TAP register when the pointer moves to a column specified by the STOP register (split data transfer).

This function cannot be used when the jump destination address is not set (TAP register is empty).

This function facilitates tile map application which divides the screen into tiles and manages data for each tile.

3.6.1 Usage of Binary Boundary Jump Function

After setting the STOP register, execute the single read (or write) data transfer and initialize the serial access port. The initialization process will switch the serial access port read (or write) operations, set TAP, set the serial access port data, and set the TAP register to empty. By inputting the serial clock in this state, the serial access port will read (or write) operations from TAP in ascending order of address. Because the TAP register is in the empty state, the address at the jump source set by the STOP register will be ignored, and the serial address pointer will move on.

When the column to be jumped approaches, execute split data transfer and set new TAP data in the TAP register. The serial pointer will jump at the desired jump source address. Jump can be controlled freely by repeating these operations.

3.7 Special Operations

3.7.1 Serial Address Set Operations

Because the serial address counter is undefined when the power up, the serial access port operations when the SC clock is input are not guaranteed. Execute single read (or write) transfer after turning on the power. The serial access port will be initialized, enabling serial access port operations to be performed.

3.7.2 Lap Around Operations

If all the data of the register is read (write) during data transfer while the serial read (write) cycle is being executed, the serial pointer will repeat 0 to 511.

3.7.3 Cycle After Power On

After supplying power, initialize the internal circuitry by waiting for at least 100 μ s after $V_{CC} \geq 4.5$ V, then supplying at least 8 \overline{RAS} clock cycles. The \overline{RAS} clock only requires that t_{RC} , t_{RAS} , and t_{RP} are satisfied; there is no problem if other signals are in any state. Note however that if the signal supplied to \overline{RAS} , \overline{CAS} , $\overline{DT/OE}$, and $\overline{WB/WE}$ is high at power-on, the serial access port and each register have the following values.

- Serial access port Input mode, SIO: High impedance
- Color register Undefined
- Mask register All "1"
- TAP register Undefined
- STOP register Undefined

4. Electrical Characteristics

Absolute Maximum Ratings

Parameter	Symbol	Rating	Unit
Pin voltage	V _T	-1.0 to +7.0	V
Supply voltage	V _{CC}	-1.0 to +7.0	V
Output current	I _O	50	mA
Power dissipation	P _D	1.5	W
Operating ambient temperature	T _A	0 to 70	°C
Storage temperature	T _{stg}	-55 to +125	°C

Caution Exposing the device to stress above those listed in Absolute Maximum Ratings could cause permanent damage. The device is not meant to be operated under conditions outside the limits in the operational sections of this characteristics. Exposure to Absolute Maximum rating conditions for extended periods may affect device reliability.

Recommended Operating Conditions

Parameter	Symbol	MIN.	TYP.	MAX.	Unit
Supply voltage	V _{CC}	4.5	5.0	5.5	V
High level input voltage	V _{IH}	2.4		5.5	V
Low level input voltage	V _{IL}	-1.0		+0.8	V
Operating ambient temperature	T _A	0		70	°C

DC Characteristics 1 (Recommended operating conditions unless otherwise noted)

Parameter	Symbol	Test conditions	MIN.	TYP.	MAX.	Unit
Input leakage current	I _{IL}	V _{IN} = 0 V to 5.5 V, Other inputs are 0 V	-10		+10	μA
Output leakage current	I _{OL}	W/IO, SIO, QSF are inactive, V _{OUT} = 0 V to 5.5 V	-10		+10	μA
Random access port high level output voltage	V _{OH} (R)	I _{OH} (R) = -1.0mA	2.4			V
Random access port low level output voltage	V _{OL} (R)	I _{OL} (R) = 2.1mA			0.4	V
Serial access port high level output voltage	V _{OH} (S)	I _{OH} (S) = -1.0mA	2.4			V
Serial access port low level output voltage	V _{OL} (S)	I _{OL} (S) = 2.1mA			0.4	V

Capacitance (T_A = 25 °C, f = 1MHz)

Parameter	Symbol	Test conditions	MIN.	TYP.	MAX.	Unit
Input Capacitance	C _{I1}	RAS, CAS, WB/WE, DT/OE, DSF, SE, SC			8	pF
	C _{I2}	A0 to A8			5	
Input/Output Capacitance	C _{IO}	W/IO (0 to 7), SIO (0 to 7)			7	pF
Output Capacitance	C _O	QSF			7	pF

DC Characteristics 2 (Recommended operating conditions unless otherwise noted)^{Note 1}
 (μPD482234)

Random Access Port	Serial Access Port		Symbol	μPD482234-60		μPD482234-70		Unit	Conditions
	Standby	Active		MIN.	MAX.	MIN.	MAX.		
Random Read/Write Cycle RAS, CAS cycle, t _{RC} = t _{RC} (MIN.), I _O = 0mA	○		I _{CC1}		110		130	mA	Note 2
		○	I _{CC7}		155		195		
Standby RAS = CAS = V _{IH} , D _{OUT} = high impedance	○		I _{CC2}		10		10	mA	Note 3
						1			
		○	I _{CC8}		55		70	mA	
RAS only refresh cycle RAS cycle, CAS = V _{IH} , t _{RC} = t _{RC} (MIN.)	○		I _{CC3}		110		115		
		○	I _{CC9}		155		180		
Fast page mode cycle RAS = V _{IL} , CAS cycle, t _{PC} = t _{PC} (MIN.)	○		I _{CC4}		100		100	mA	Note 5
		○		I _{CC10}		145			
CAS before RAS refresh cycle t _{RC} = t _{RC} (MIN.)	○		I _{CC5}		110		90	mA	
		○		I _{CC11}		155			
Data transfer cycle t _{RC} = t _{RC} (MIN.)	○		I _{CC6}		120		140	mA	
		○		I _{CC12}		165			
Color/Mask write register set cycle t _{RC} = t _{RC} (MIN.)	○		I _{CC13}		100		120	mA	
		○		I _{CC14}		145			
Flash write cycle t _{RC} = t _{RC} (MIN.)	○		I _{CC15}		100		120	mA	
		○		I _{CC16}		145			
Block write cycle t _{RC} = t _{RC} (MIN.)	○		I _{CC17}		120		130	mA	
		○		I _{CC18}		165			
Fast page mode block write cycle t _{PC} = t _{PC} (MIN.)	○		I _{CC19}		100		110	mA	Note 5
		○		I _{CC20}		130			

- Notes**
1. No load on W/I/O, SIO, QSF. The current consumption actually used depends on the output load and operating frequency of each pin.
 2. A change in row addresses must not occur more than once in t_{RC} = t_{RC} (MIN.).
 3. RAS, CAS, and SE remain at V_{IH} ≥ V_{CC} - 0.2 V, and A0 to A8, WB/WE, DT/OE, DSF, SC remain at V_{IH} ≥ V_{CC} - 0.2 V or V_{IL} ≤ GND + 0.2 V.
 4. When the address input is set to V_{IH} or V_{IL} during the t_{RAS} period.
 5. Value when the address in t_{PC} one cycle is changed once when t_{PC} = t_{PC} (MIN.).

DC Characteristics 2 (Recommended operating conditions unless otherwise noted) ^{Note 1}
 (μPD482235)

Random Access Port	Serial Access Port		Symbol	μPD482235-60		μPD482235-70		Unit	Conditions
	Standby	Active		MIN.	MAX.	MIN.	MAX.		
Random Read/Write Cycle RAS, CAS cycle, t _{RC} = t _{RC} (MIN.), I _O = 0mA	○		I _{CC1}		110		130	mA	Note 2
		○	I _{CC7}		155		195		
Standby RAS = CAS = V _{IH} , D _{OUT} = high impedance	○		I _{CC2}		10		10	mA	Note 3
		○	I _{CC8}		55		70		
RAS only refresh cycle RAS cycle, CAS = V _{IH} , t _{RC} = t _{RC} (MIN.)	○		I _{CC3}		110		115	mA	Note 4
		○	I _{CC9}		155		180		
Hyper page mode cycle RAS = V _{IL} , CAS cycle, t _{HPC} = t _{HPC} (MIN.)	○		I _{CC4}		120		130	mA	Note 5
		○	I _{CC10}		155		195		
CAS before RAS refresh cycle t _{RC} = t _{RC} (MIN.)	○		I _{CC5}		110		90	mA	
		○	I _{CC11}		155		155		
Data transfer cycle t _{RC} = t _{RC} (MIN.)	○		I _{CC6}		120		140	mA	
		○	I _{CC12}		165		205		
Color/Mask write register set cycle t _{RC} = t _{RC} (MIN.)	○		I _{CC13}		100		120	mA	
		○	I _{CC14}		145		185		
Flash write cycle t _{RC} = t _{RC} (MIN.)	○		I _{CC15}		100		120	mA	
		○	I _{CC16}		145		185		
Block write cycle t _{RC} = t _{RC} (MIN.)	○		I _{CC17}		120		130	mA	
		○	I _{CC18}		165		195		
Hyper page mode block write cycle t _{HPC} = t _{HPC} (MIN.)	○		I _{CC19}		140		135	mA	Note 5
		○	I _{CC20}		190		200		

- Notes**
1. No load on W/I/O, SIO, QSF. The current consumption actually used depends on the output load and operating frequency of each pin.
 2. A change in row addresses must not occur more than once in t_{RC} = t_{RC} (MIN.).
 3. RAS, CAS, and SE remain at V_{IH} ≥ V_{CC} - 0.2 V, and A0 to A8, WB/WE, DT/OE, DSF, SC remain at V_{IH} ≥ V_{CC} - 0.2 V or V_{IL} ≤ GND + 0.2 V.
 4. When the address input is set to V_{IH} or V_{IL} during the t_{RAS} period.
 5. Value when the address in t_{HPC} one cycle is changed once when t_{HPC} = t_{HPC} (MIN.).

AC Characteristics (Recommended operating conditions unless otherwise noted)

- All applied voltages are referenced to GND.
- After supplying power, initialize the internal circuitry by waiting for at least 100 μs after $V_{CC} \geq 4.5$ V, then supplying at least 8 \overline{RAS} clock cycles. The \overline{RAS} clock only requires t_{RC} , t_{RAS} , and t_{RP} are satisfied; there is no problem if other signals are in any state.
- Measure at $t_r = 5$ ns
- AC characteristic measuring conditions

(1) Input voltage, timing

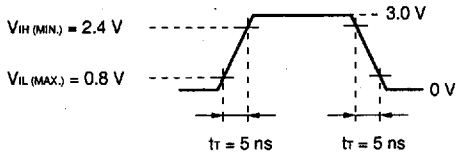

(2) Output voltage determined

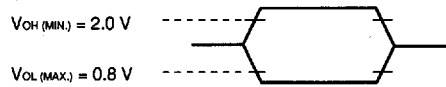

(3) Output load conditions

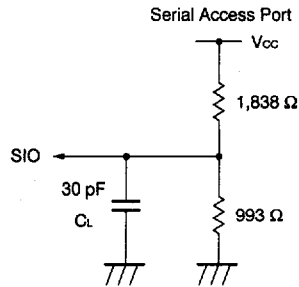
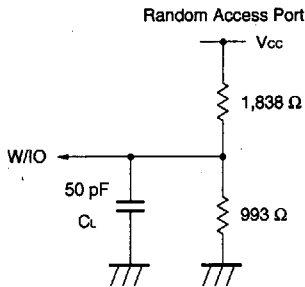

(Common)

(1/2)

Parameter	Symbol	μPD482234-60 μPD482235-60		μPD482234-70 μPD482235-70		Unit	Conditions
		MIN.	MAX.	MIN.	MAX.		
Random read or write cycle time	trc	120		140		ns	
Access time from $\overline{\text{RAS}}$	trAC		60		70	ns	Note 1
Access time from $\overline{\text{CAS}}$	tcAC		15		20	ns	Note 1
Access time from column address	tAA		30		35	ns	Note 1
Access time from $\overline{\text{OE}}$	toEA		15		20	ns	
RAS precharge time	trP	50		60		ns	
CAS precharge time (Non page mode)	tcPN	10		10		ns	
CAS precharge time (Fast page/Hyper page mode)	tcP	10		10		ns	
CAS high to RAS low precharge time	tcRP	5		10		ns	
RAS high to CAS low precharge time	trPC	10		10		ns	
RAS pulse width (Non page mode)	trAS	60	10,000	70	10,000	ns	
RAS pulse width (Fast page/Hyper page mode)	trASP	60	100,000	70	100,000	ns	
CAS pulse width	tcAS	15	10,000	20	10,000	ns	
CAS pulse width	tcCAS	10	10,000	10	10,000	ns	
Write command pulse width	twP	10		12		ns	
$\overline{\text{RAS}}$ hold time	trSH	15		20		ns	
$\overline{\text{CAS}}$ hold time	tcSH	60		70		ns	
Row address setup time	tASR	0		0		ns	
Row address hold time	trAH	10		10		ns	
Column address setup time	tASC	0		0		ns	
Column address hold time	tcAH	10		10		ns	
Read command setup time	trCS	0		0		ns	
Data in setup time	tdS	0		0		ns	Note 2
Data in hold time	tdH	12		12		ns	Note 2
$\overline{\text{DT}}$ high setup time	tdHS	0		0		ns	
$\overline{\text{DT}}$ high hold time	tdHH	10		10		ns	
Write-per-bit setup time	twBS	0		0		ns	
Write-per-bit hold time	twBH	10		10		ns	
DSF setup time from $\overline{\text{RAS}}$	tFRS	0		0		ns	
DSF hold time from $\overline{\text{RAS}}$	tFRH	10		10		ns	
DSF setup time from $\overline{\text{CAS}}$	tFCS	0		0		ns	
DSF hold time from $\overline{\text{CAS}}$	tFCH	10		12		ns	

(2/2)

Parameter	Symbol	μPD482234-60 μPD482235-60		μPD482234-70 μPD482235-70		Unit	Conditions
		MIN.	MAX.	MIN.	MAX.		
Write-per-bit selection setup time	tws	0		0		ns	
Write-per-bit selection hold time	twh	10		10		ns	
Column address to $\overline{\text{RAS}}$ lead time	trAL	30		35		ns	
Write command to $\overline{\text{RAS}}$ lead time	trWL	20		20		ns	
Write command to $\overline{\text{CAS}}$ lead time	tcWL	15		15		ns	
$\overline{\text{RAS}}$ to $\overline{\text{CAS}}$ delay time	trCD	20	40	20	50	ns	Note 1
$\overline{\text{RAS}}$ to column address delay time	trAD	15	30	15	35	ns	Note 1
Output disable time from $\overline{\text{RAS}}$ high	toFR	0	15	0	15	ns	Notes 3, 4
Output disable time from $\overline{\text{CAS}}$ high	toFF	0	15	0	15	ns	Notes 3, 4
Output disable time from $\overline{\text{CAS}}$ high (Hyper page mode)	toFC	0	15	0	15	ns	Notes 3, 4
Output disable time from $\overline{\text{OE}}$ high	toEZ	0	15	0	15	ns	Notes 3, 4
Output disable time from $\overline{\text{WB/WE}}$ low	tweZ	0	15	0	15	ns	Notes 3, 4
Write command pulse width	twpZ	10		12		ns	Note 4
Transition time (Rise/Fall)	tr	3	35	3	35	ns	

Notes 1. For read cycle, access time is defined as follows:

Input conditions	Access time	Access time from $\overline{\text{RAS}}$
$t_{\text{RAD}} \leq t_{\text{RAD}} (\text{MAX.})$ and $t_{\text{RCD}} \leq t_{\text{RCD}} (\text{MAX.})$	$t_{\text{RAC}} (\text{MAX.})$	$t_{\text{RAC}} (\text{MAX.})$
$t_{\text{RAD}} > t_{\text{RAD}} (\text{MAX.})$ and $t_{\text{RCD}} \leq t_{\text{RCD}} (\text{MAX.})$	$t_{\text{AA}} (\text{MAX.})$	$t_{\text{RAD}} + t_{\text{AA}} (\text{MAX.})$
$t_{\text{RCD}} > t_{\text{RCD}} (\text{MAX.})$	$t_{\text{CAC}} (\text{MAX.})$	$t_{\text{RCD}} + t_{\text{CAC}} (\text{MAX.})$

$t_{\text{RAD}} (\text{MAX.})$ and $t_{\text{RCD}} (\text{MAX.})$ are specified as reference points only; they are not restrictive operating parameters. They are used to determine which access time (t_{RAC} , t_{AA} , t_{CAC}) is to be used for finding out data will be available. Therefore, the input conditions $t_{\text{RAD}} \geq t_{\text{RAD}} (\text{MAX.})$ and $t_{\text{RCD}} \geq t_{\text{RCD}} (\text{MAX.})$ will not cause any operation problems.

2. These parameters are referenced to the following points.
 - (1) Early write cycle : The falling edge of $\overline{\text{CAS}}$
 - (2) Late write cycle : The falling edge of $\overline{\text{WB/WE}}$
 - (3) Read modify write cycle : The falling edge of $\overline{\text{WB/WE}}$
3. tSEZ, toEZ, tweZ, toFF, toFR, and toFC define the time when the output achieves the condition of high impedance and is not referenced to V_{OH} or V_{OL} .

4. Control pins \overline{RAS} , \overline{CAS} , $\overline{DT/OE}$, $\overline{WB/WE}$ to set pin W/I/O to high impedance. Because the timings at which \overline{RAS} , \overline{CAS} and $\overline{DT/OE}$ are set to high level and $\overline{WB/WE}$ is set to low level affect the high impedance state, the specifications will change as follows. Controlling by \overline{RAS} is usable in hyper page mode (μPD482235).

Fast page mode (μPD482234)

	\overline{RAS}	\overline{CAS}	$\overline{DT/OE}$	$\overline{WB/WE}$	Remark
t _{OFF}	x	L → H	L	H	
t _{WEZ}	x	L	L	H → L	t _{WPZ} should be met.
t _{OEZ}	x	L	L → H	H	

Hyper page mode (μPD482235)

	\overline{RAS}	\overline{CAS}	$\overline{DT/OE}$	$\overline{WB/WE}$	Remark
t _{OFH}	L → H	H	L	H	
t _{OFH}	H	L → H	L	H	
t _{WEZ}	L	L	L	H → L	t _{WPZ} should be met.
t _{OEZ}	L	L	L → H	H	

Remark H : High level
 L : Low level
 x : Don't care
 → : Transition

(Read cycle)

Parameter	Symbol	μPD482234-60 μPD482235-60		μPD482234-70 μPD482235-70		Unit	Conditions
		MIN.	MAX.	MIN.	MAX.		
Random read or write cycle time	trc	120		140		ns	
Fast page mode cycle time	tpc	40		45		ns	
Hyper page mode cycle time	thpc	30		35		ns	
Access time from $\overline{\text{RAS}}$	trac		60		70	ns	Note 1
Access time from $\overline{\text{CAS}}$	tcac		15		20	ns	Note 1
Access time from column address	tAA		30		35	ns	Note 1
Access time from $\overline{\text{OE}}$	toEA		15		20	ns	
Access time from $\overline{\text{CAS}}$ trailing edge	tACP		35		40	ns	
$\overline{\text{OE}}$ to $\overline{\text{RAS}}$ inactive setup time	toES	0		0		ns	
Read command hold time after $\overline{\text{RAS}}$ high	trRH	0		0		ns	Note 2
Read command hold time after $\overline{\text{CAS}}$ high	trCH	0		0		ns	Note 2
Output hold time from $\overline{\text{CAS}}$	tdHC	3		5		ns	
Output disable time from $\overline{\text{RAS}}$ high	toFR	0	15	0	15	ns	Notes 3, 4
Output disable time from $\overline{\text{CAS}}$ high	toFF	0	15	0	15	ns	Notes 3, 4
Output disable time from $\overline{\text{CAS}}$ high (Hyper page mode)	toFC	0	15	0	15	ns	Notes 3, 4
Output disable time from $\overline{\text{OE}}$ high	toEZ	0	15	0	15	ns	Notes 3, 4
Output disable time from $\overline{\text{WB}}/\overline{\text{WE}}$ low	tWEZ	0	15	0	15	ns	Notes 3, 4
Write command pulse width	tWPZ	10		12		ns	Note 4

Notes 1. For read cycle, access time is defined as follows:

Input conditions	Access time	Access time from $\overline{\text{RAS}}$
$\text{trAD} \leq \text{trAD (MAX.)}$ and $\text{trCD} \leq \text{trCD (MAX.)}$	trAC (MAX.)	trAC (MAX.)
$\text{trAD} > \text{trAD (MAX.)}$ and $\text{trCD} \leq \text{trCD (MAX.)}$	tAA (MAX.)	$\text{trAD} + \text{tAA (MAX.)}$
$\text{trCD} > \text{trCD (MAX.)}$	tcAC (MAX.)	$\text{trCD} + \text{tcAC (MAX.)}$

trAD (MAX.) and trCD (MAX.) are specified as reference points only; they are not restrictive operating parameters. They are used to determine which access time (trAC , tAA , tcAC) is to be used for finding out data will be available. Therefore, the input conditions $\text{trAD} \geq \text{trAD (MAX.)}$ and $\text{trCD} \geq \text{trCD (MAX.)}$ will not cause any operation problems.

2. Either trCH (MIN.) or trRH (MIN.) should be met in read cycles.
3. tSEZ , toEZ , tWEZ , toFF , toFR , and toFC define the time when the output achieves the condition of high impedance and is not referenced to V_{OH} or V_{OL} .

4. Control pins $\overline{\text{RAS}}$, $\overline{\text{CAS}}$, $\overline{\text{DT/OE}}$, $\overline{\text{WB/WE}}$ to set pin W/IO to high impedance. Because the timings at which $\overline{\text{RAS}}$, $\overline{\text{CAS}}$ and $\overline{\text{DT/OE}}$ are set to high level and $\overline{\text{WB/WE}}$ is set to low level affect the high impedance state, the specifications will change as follows. Controlling by $\overline{\text{RAS}}$ is usable in hyper page mode (μPD482235).

Fast page mode (μPD482234)

	$\overline{\text{RAS}}$	$\overline{\text{CAS}}$	$\overline{\text{DT/OE}}$	$\overline{\text{WB/WE}}$	Remark
t _{OFF}	x	L → H	L	H	
t _{WEZ}	x	L	L	H → L	t _{wpz} should be met.
t _{OEZ}	x	L	L → H	H	

Hyper page mode (μPD482235)

	$\overline{\text{RAS}}$	$\overline{\text{CAS}}$	$\overline{\text{DT/OE}}$	$\overline{\text{WB/WE}}$	Remark
t _{OFR}	L → H	H	L	H	
t _{ofc}	H	L → H	L	H	
t _{WEZ}	L	L	L	H → L	t _{wpz} should be met.
t _{OEZ}	L	L	L → H	H	

Remark H : High level
 L : Low level
 x : Don't care
 → : Transition

Read Cycle (μPD482234)

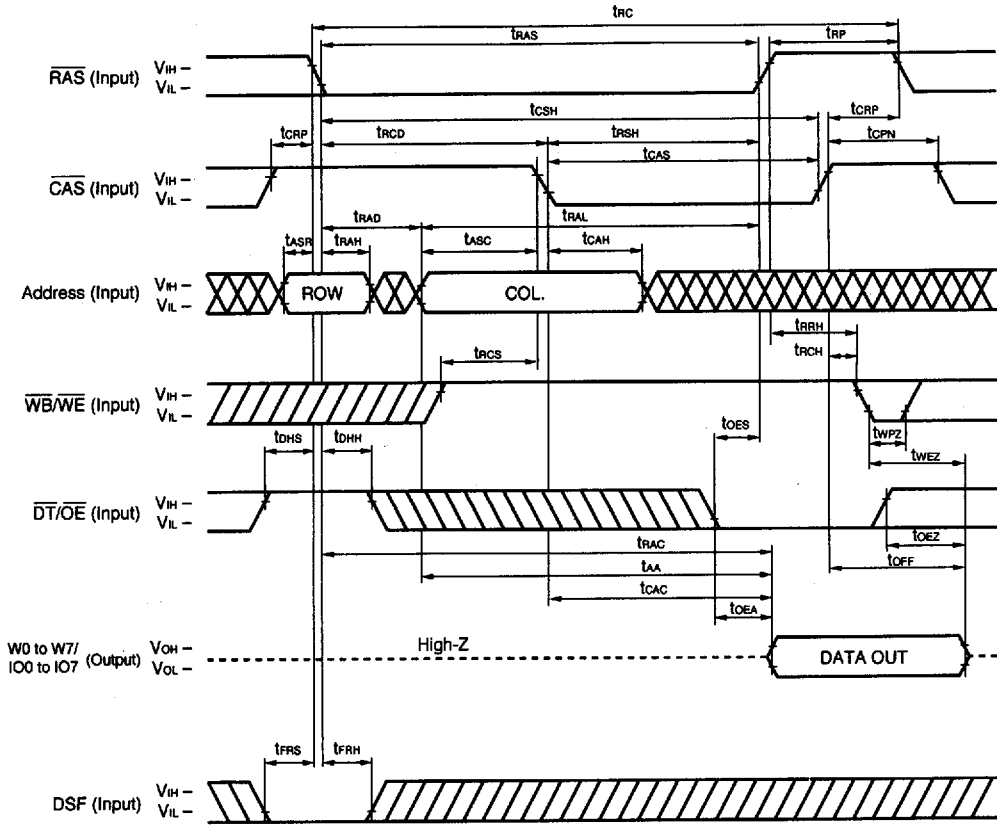

Remark Because the serial access port operates independently of the random access port, there is no need to control the SC, \overline{SE} , SIO pins in this cycle.

Read Cycle (Extended data output: μ PD482235)

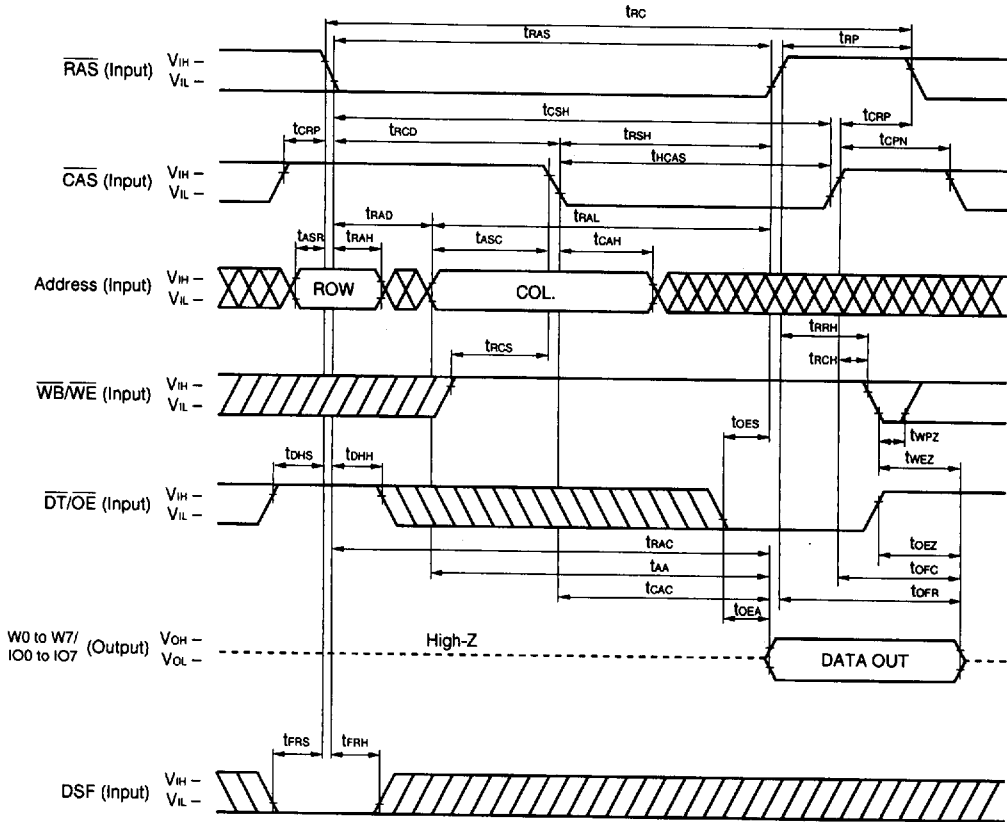

Remark Because the serial access port operates independently of the random access port, there is no need to control the SC, \overline{SE} , SIO pins in this cycle.

(Write cycle)

Parameter	Symbol	μPD482234-60 μPD482235-60		μPD482234-70 μPD482235-70		Unit	Conditions
		MIN.	MAX.	MIN.	MAX.		
Random read or write cycle time	trc	120		140		ns	
Fast page mode cycle time	tpc	40		45		ns	
Hyper page mode cycle time	thpc	30		35		ns	
Write command setup time	twcs	0		0		ns	Note
Write command hold time	twch	10		12		ns	
\overline{OE} high hold time after $\overline{WB}/\overline{WE}$ low	toeh	0		0		ns	
Write-per-bit setup time	twbs	0		0		ns	
Write-per-bit hold time	twbh	10		10		ns	
Write-per-bit selection setup time	tws	0		0		ns	
Write-per-bit selection hold time	twh	10		10		ns	

Note $twcs \geq twcs (MIN.)$ is the condition for early write cycle to be set. $Dout$ becomes high impedance during the cycle.

$trwd \geq trwd (MIN.)$, $tcwd \geq tcwd (MIN.)$, $tawd \geq tawd (MIN.)$, are conditions for read modify write cycle to be set. The data of the selected address is output to $Dout$.

If any of the above conditions are not met, pin W/I/O will become undefined.

Early Write Cycle/Early Block Write Cycle

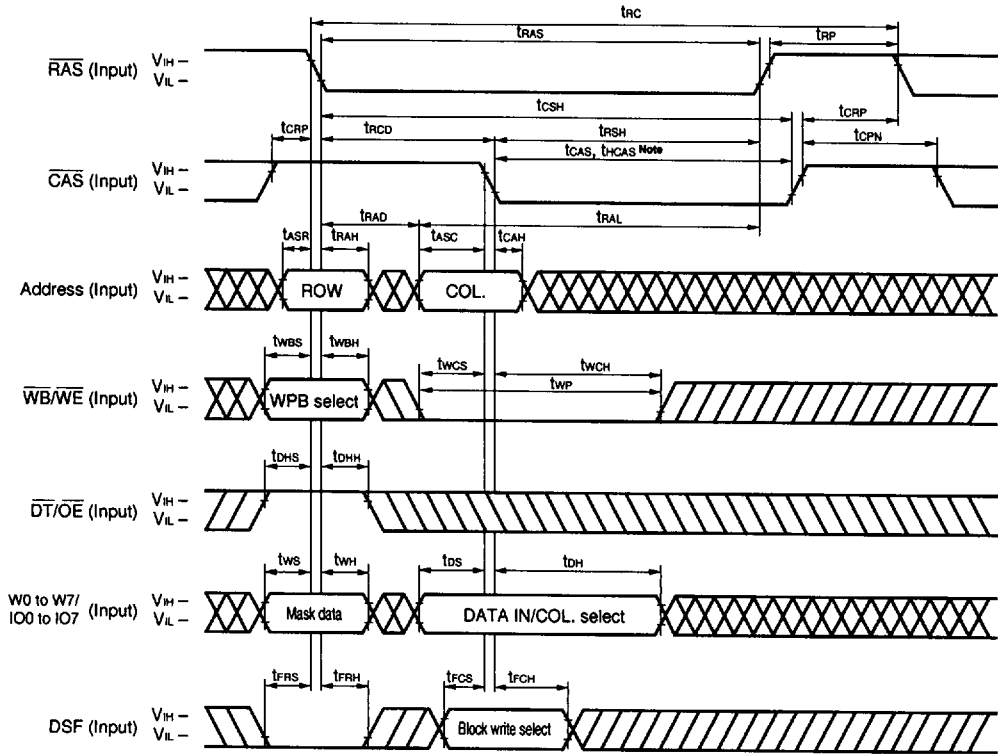

Note t_{CAS} for the μPD482234
 t_{HCAS} for the μPD482235

- Remarks**
1. When DSF is high level : Block write cycle
 When DSF is low level : Write cycle
 2. WPB : Write-per-bit
 3. When block write cycle is selected, input the column selection data to DATA IN.
 4. Because the serial access port operates independently of the random access port, there is no need to control the SC, \overline{SE} , SIO pins in this cycle.

Fast Page, Hyper Page Mode Early Write Cycle/Fast Page, Hyper Page Mode Early Block Write Cycle

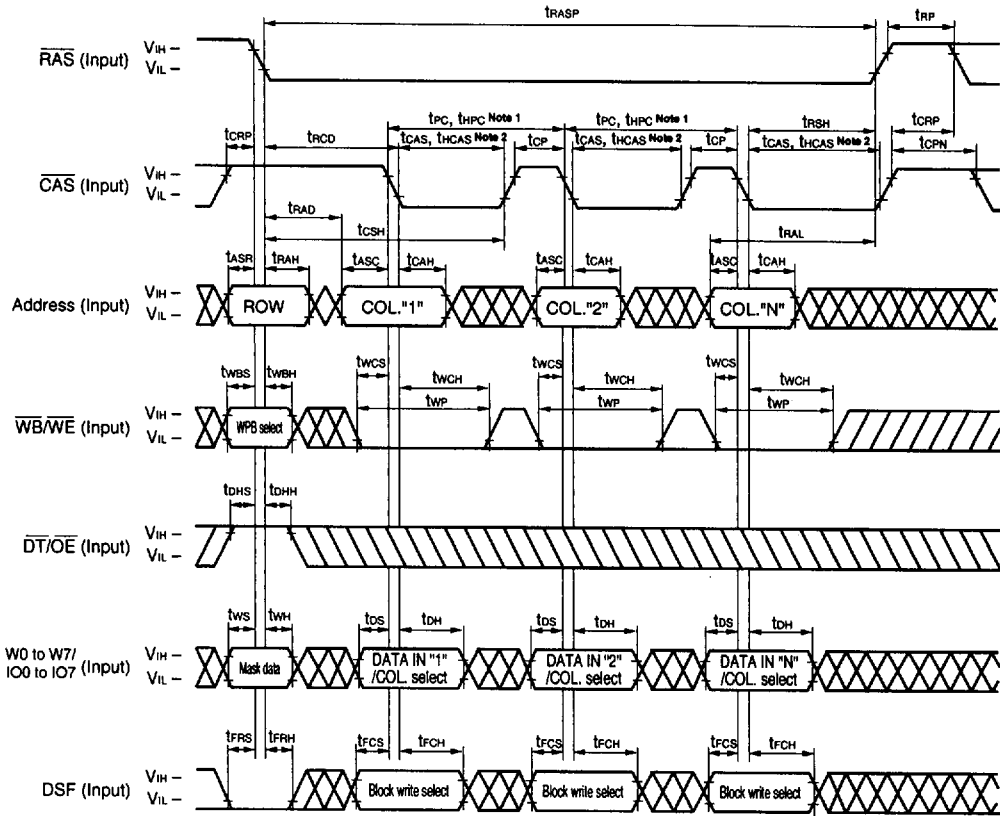

- Notes**
1. tPC for the μPD482234
tHPC for the μPD482235
 2. tCAS for the μPD482234
tHCAS for the μPD482235

- Remarks**
1. When DSF is high level : Block write cycle
When DSF is low level : Write cycle
 2. WPB : Write-per-bit
 3. When block write cycle is selected, input the column selection data to DATA IN.
 4. Because the serial access port operates independently of the random access port, there is no need to control the SC, SE, SIO pins in this cycle.

Flash Write Cycle

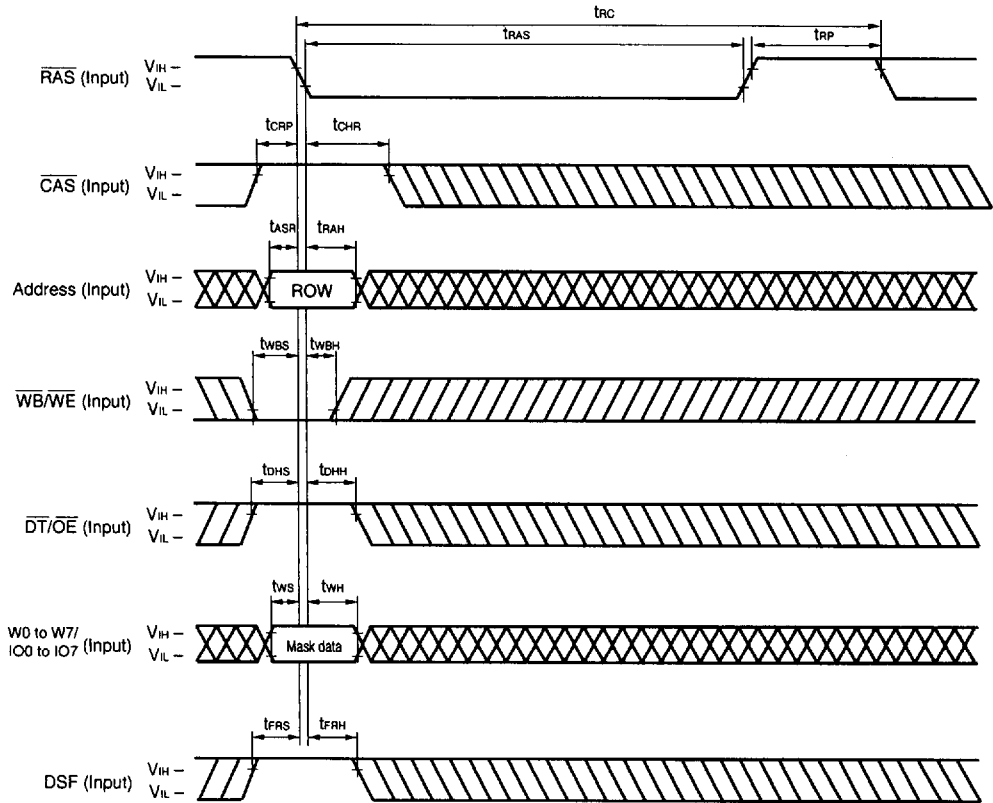

Remark Because the serial access port operates independently of the random access port, there is no need to control the SC, \overline{SE} , SIO pins in this cycle.

(Read modify write cycle)

Parameter	Symbol	μPD482234-60 μPD482235-60		μPD482234-70 μPD482235-70		Unit	Conditions
		MIN.	MAX.	MIN.	MAX.		
Read modify write cycle time	t _{RWC}	165		185		ns	
Fast page mode read modify write cycle time	t _{PRWC}	90		90		ns	
Hyper page mode read modify write cycle time	t _{HPRWC}	80		90		ns	
Access time from $\overline{\text{CAS}}$ trailing edge	t _{ACP}		35		40	ns	
Access time from previous $\overline{\text{CAS}}$	t _{ACE}		60		65		Note 1
Access time from previous $\overline{\text{WB/WE}}$	t _{AWE}		55		60		Note 1
Write-per-bit setup time	t _{WBS}	0		0		ns	
Write-per-bit hold time	t _{WBH}	10		10		ns	
Write-per-bit selection setup time	t _{WS}	0		0		ns	
Write-per-bit selection hold time	t _{WH}	10		10		ns	
$\overline{\text{OE}}$ high hold time after $\overline{\text{WB/WE}}$ low	t _{OEHL}	0		0		ns	
$\overline{\text{CAS}}$ to $\overline{\text{WB/WE}}$ delay time	t _{CWD}	40		40		ns	Note 2
$\overline{\text{RAS}}$ to $\overline{\text{WB/WE}}$ delay time	t _{RWD}	85		90		ns	Note 2
Column address to $\overline{\text{WB/WE}}$ delay time	t _{AWD}	55		55		ns	Note 2
$\overline{\text{OE}}$ high to data in setup delay time	t _{OED}	15		15		ns	

Notes 1. In the hyper page mode, the hyper page mode read modify write cycle, the hyper page mode read modify block write cycle, this parameter is valid when the read cycle changes to the write cycle.

2. $t_{\text{WCS}} \geq t_{\text{WCS}}(\text{MIN.})$ is the condition for early write cycle to be set. Dout becomes high impedance during the cycle.

$t_{\text{RWD}} \geq t_{\text{RWD}}(\text{MIN.})$, $t_{\text{CWD}} \geq t_{\text{CWD}}(\text{MIN.})$, $t_{\text{AWD}} \geq t_{\text{AWD}}(\text{MIN.})$, are conditions for read modify write cycle to be set. The data of the selected address is output to Dout.

If any of the above conditions are not met, pin W/I/O will become undefined.

**Hyper Page Mode Read Modify Write Cycle (Extended data output: μPD482235)/
Hyper Page Mode Read Modify Block Write Cycle (Extended data output: μPD482235)**

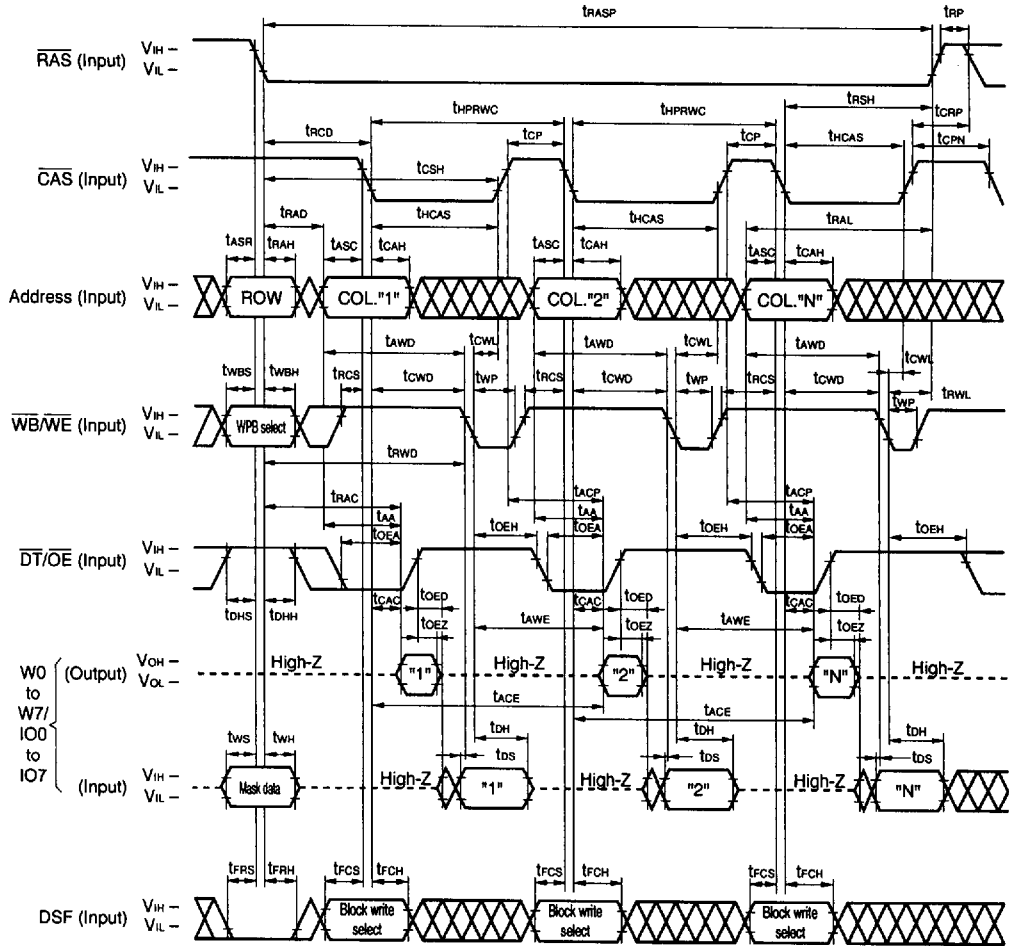

- Remarks**
1. When DSF is high level : Block write cycle
When DSF is low level : Write cycle
 2. WPB : Write-per-bit
 3. When block write cycle is selected, input the column selection data to DATA IN.
 4. Because the serial access port operates independently of the random access port, there is no need to control the SC, \overline{SE} , SIO pins in this cycle.

(Refresh cycle)

Parameter	Symbol	μPD482234-60 μPD482235-60		μPD482234-70 μPD482235-70		Unit	Conditions
		MIN.	MAX.	MIN.	MAX.		
Refresh period	tREF		8		8	ms	
RAS high to CAS low precharge time	tRPC	10		10		ns	
CAS setup time (for CAS before RAS refresh cycle)	tCSR	0		0		ns	
CAS hold time (for CAS before RAS refresh cycle)	tCHR	10		10		ns	
OE to RAS inactive setup time	toES	0		0		ns	
SC setup time from RAS	tsRS	10		10		ns	Notes 1, 2, 3
SC hold time from RAS	tsRH	10		10		ns	Note 1

Notes 1. The tsRS and tsRH in the hidden refresh cycle, CAS before RAS refresh cycle (STOP register set cycle and optional reset cycle) are specified to guarantee the serial port operations until the transfer cycle is executed after the STOP register value is changed. When the STOP register value is not to be changed, or when the binary boundary jump function is not used (when the TAP register is empty), tsRS and tsRH will not be specified.

2. tSSC (split read data transfer cycle) and tsRS (split write data transfer cycle) are specified at the rising edge of SC which reads/writes the address of the jump source in the binary boundary jump function. tSDHR (split read data transfer cycle and split write data transfer cycle) is specified at the rising edge of SC which reads/writes the address of the jump destination in the binary boundary jump function. The rising edge of these SCs cannot be input in periods (1) and (2).

(1) Split read data transfer cycle: Period from the rising edge of the SC specifying tSSC to that of the SC specifying tSDHR (Refer to **Note 2 at the Split Read/Write Data Transfer Cycle Timing Chart.**)

(2) Split write data transfer cycle: Period from the rising edge of the SC specifying tsRS to that of the SC specifying tSDHR (Refer to **Note 2 at the Split Read/Write Data Transfer Cycle Timing Chart.**)

3. Restrictions to the split read data transfer cycle during serial write operation

(1) If split read data transfer is attempted for an address which is already involved in serial write, normal operation is not guaranteed; except for a period in which no serial write has been performed, that is from when SE goes low at the rising edge of SC to just before the serial write begins.

(2) If split read data transfer is attempted when an address involved in serial write is the boundary address specified by the STOP register, normal operation is not guaranteed, except for a period in which no serial write has been performed, that is from just after the mask write or mask split write transfer cycle is executed to just before the serial write is started by setting SE to a low level at the rising edge of SC.

RAS Only Refresh Cycle

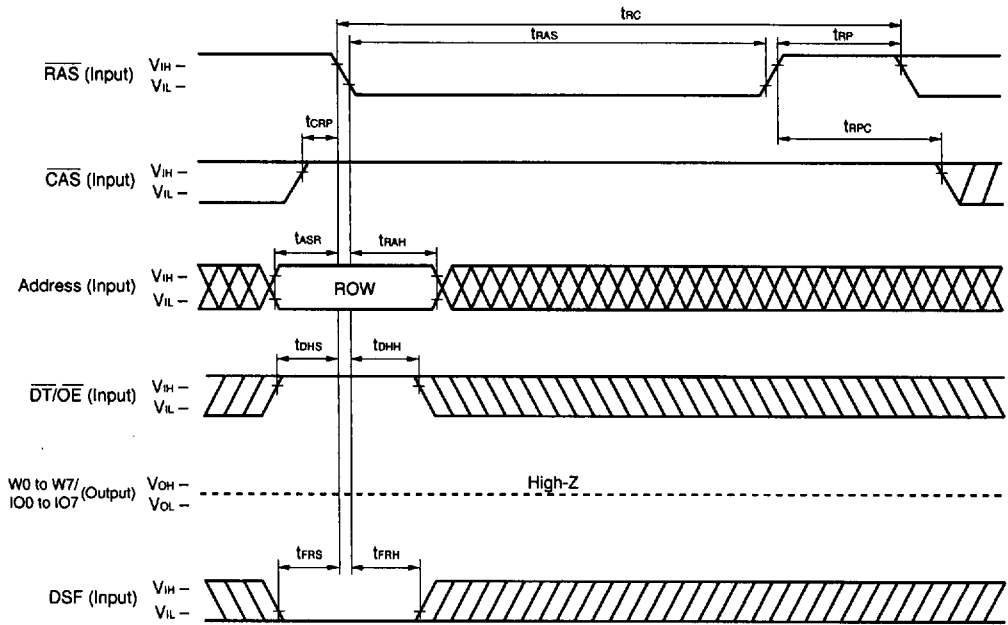

Remarks 1. $\overline{WB}/\overline{WE}$: Don't care

2. Because the serial access port operates independently of the random access port, there is no need to control the SC, \overline{SE} , SIO pins in this cycle.

CAS Before RAS Refresh Cycle (Optional Reset)

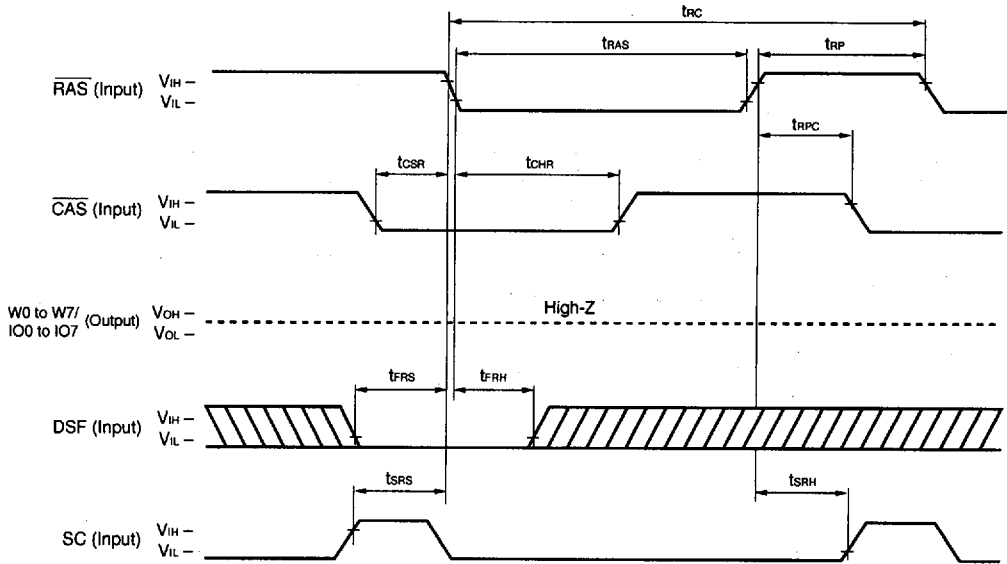

- Remarks**
1. Address, $\overline{WB}/\overline{WE}$, $\overline{DT}/\overline{OE}$: Don't care
 2. Because the serial access port operates independently of the random access port, there is no need to control the \overline{SE} , SIO pins in this cycle.

CAS Before RAS Refresh Cycle (STOP Register Set)

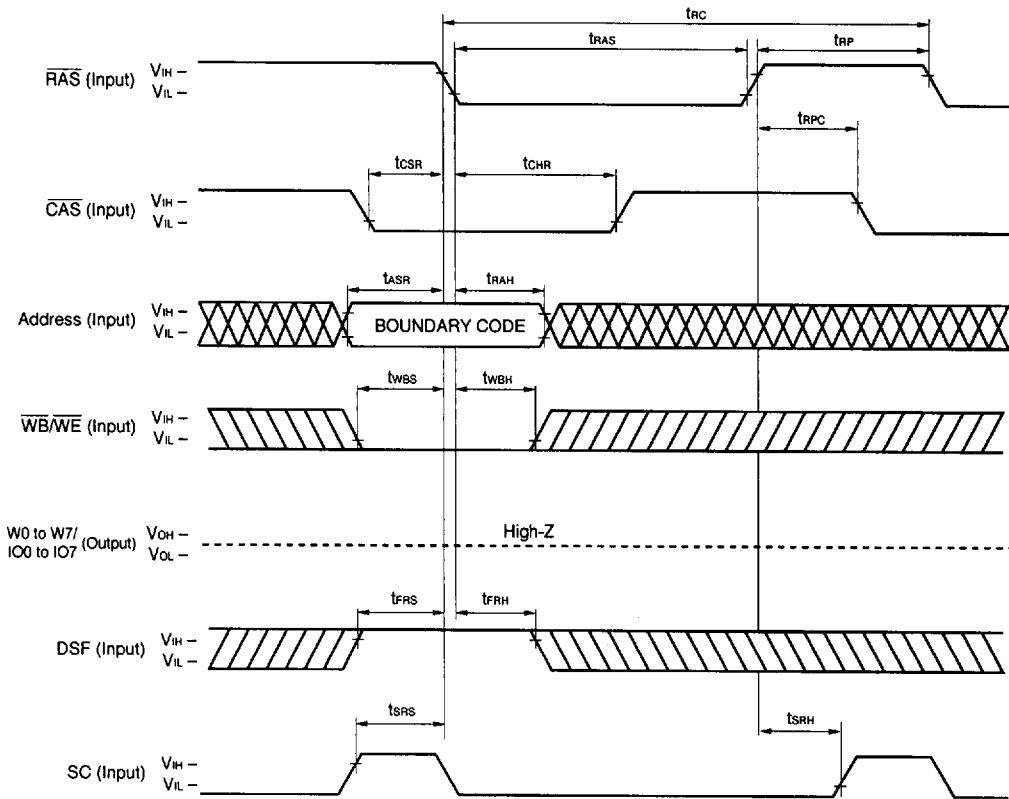

- Remarks**
1. $\overline{DT}/\overline{OE}$: Don't care
 2. Because the serial access port operates independently of the random access port, there is no need to control the \overline{SE} , SIO pins in this cycle.

Hidden Refresh Cycle (μ PD482234)

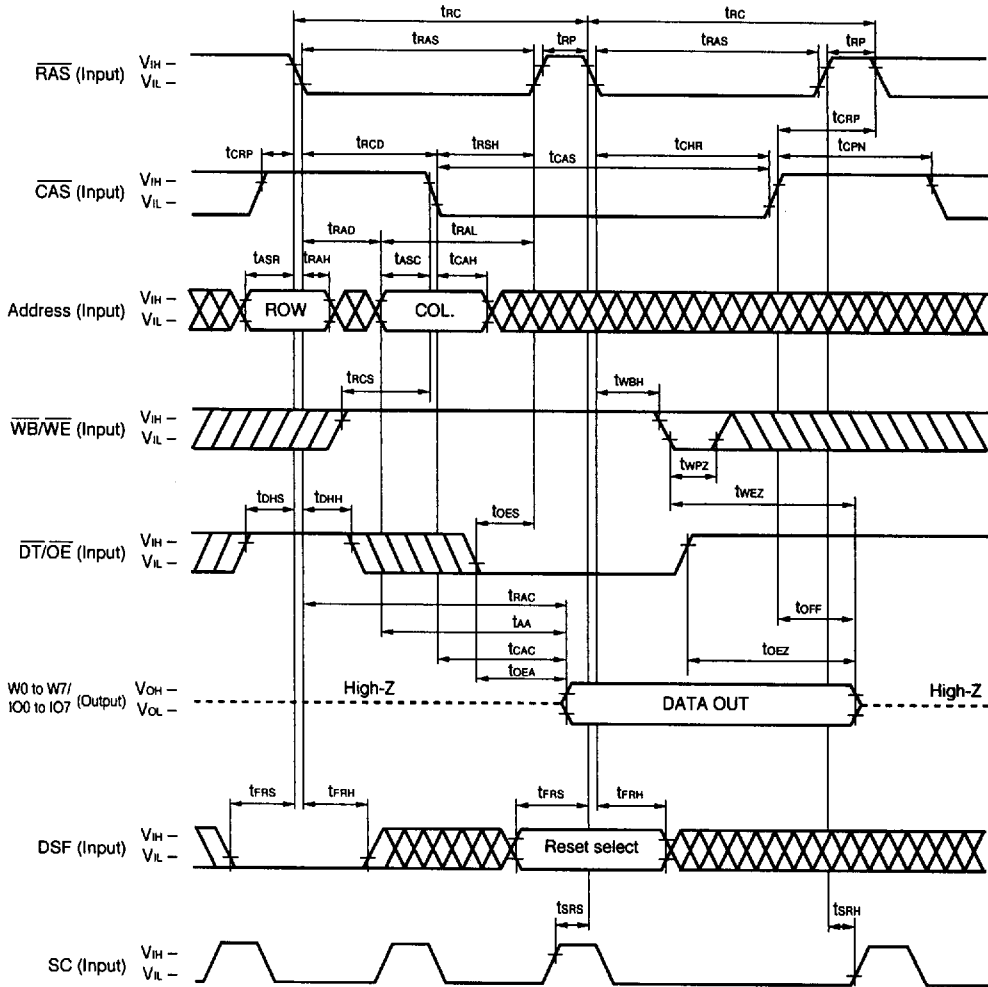

- Remarks 1.** When DSF is high level : Reset select = No Reset
 When DSF is low level : Reset select = Optional Reset
- 2.** Because the serial access port operates independently of the random access port, there is no need to control the \overline{SE} , SIO pins in this cycle.

Hidden Refresh Cycle (Extended data output: μPD482235)

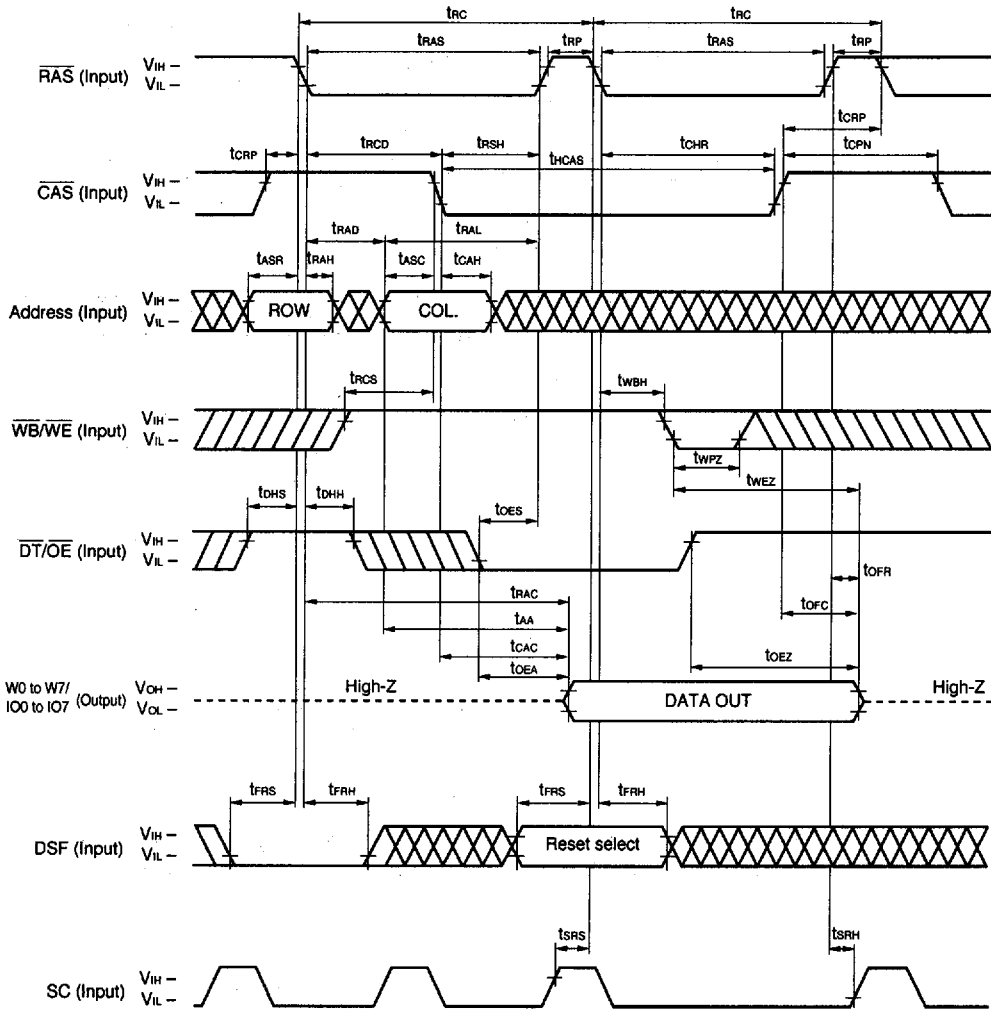

- Remarks 1.** When DSF is high level : Reset select = No Reset
 When DSF is low level : Reset select = Optional Reset
- 2.** Because the serial access port operates independently of the random access port, there is no need to control the \overline{SE} , SIO pins in this cycle.

(Register set cycle)

Parameter	Symbol	μPD482234-60 μPD482235-60		μPD482234-70 μPD482235-70		Unit	Condition
		MIN.	MAX.	MIN.	MAX.		
RAS high to CAS low precharge time	tRPC	10		10		ns	
Write command setup time	twcs	0		0		ns	Note
Write command hold time	twch	10		12		ns	

Note $twcs \geq twcs$ (MIN.) is the condition for early write cycle to be set. Dout becomes high impedance during the cycle.

$trwd \geq trwd$ (MIN.), $tcwd \geq tcwd$ (MIN.), $tawd \geq tawd$ (MIN.), are conditions for read modify write cycle to be set. The data of the selected address is output to Dout.

If any of the above conditions are not met, pin W/I/O will become undefined.

Register Set Cycle (Early Write)

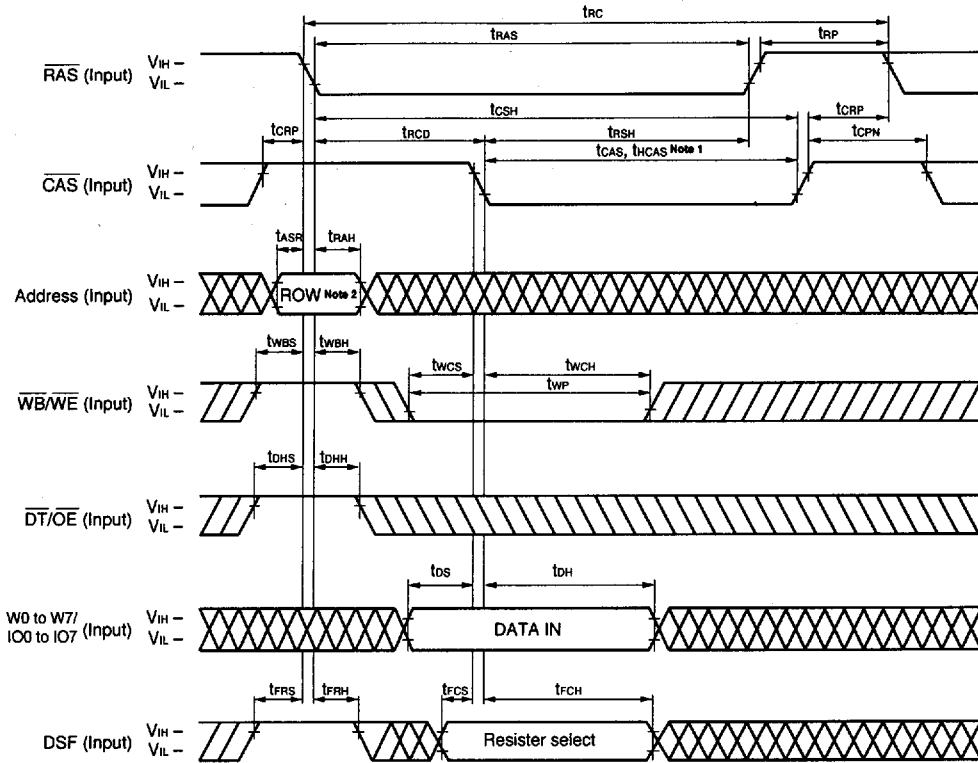

- Notes**
1. t_{CAS} for the μPD482234
 t_{tCAS} for the μPD482235
 2. Refresh address (\overline{RAS} only refresh)

- Remarks**
1. When DSF is high level : Register select = Color Register Select
 When DSF is low level : Register select = Write Mask Register Select
 2. Because the serial access port operates independently of the random access port, there is no need to control the SC, \overline{SE} , SIO pins in this cycle.

(Data transfer cycle)

Parameter	Symbol	μPD482234-60 μPD482235-60		μPD482234-70 μPD482235-70		Unit	Conditions
		MIN.	MAX.	MIN.	MAX.		
Serial clock cycle time	t _{SCC}	18		22		ns	
Serial output access time from SC	t _{SCA}		15		17	ns	
Propagation delay time from SC to QSF	t _{PD}		20		20	ns	
Propagation delay time from RAS to QSF	t _{RQD}		80		95	ns	
Propagation delay time from CAS to QSF	t _{CQD}		60		65	ns	
Propagation delay time from DT/OE to QSF	t _{DQD}		30		30	ns	
Propagation delay time from RAS high to QSF	t _{DQR}		40		40	ns	
Serial input enable time from RAS	t _{SH}	20		20		ns	
SC precharge time	t _{SCL}	5		5		ns	
SC pulse width	t _{SCH}	5		5		ns	
DT high pulse width	t _{DTP}	20		20		ns	
DT low setup time	t _{DLS}	0		0		ns	
Serial output hold time after SC high	t _{SOH}	3		5		ns	
Serial data in setup time	t _{SIS}	0		0		ns	
Serial data in hold time	t _{SIH}	10		10		ns	
SC setup time from RAS	t _{SRS}	10		10		ns	Notes 1, 2, 3
DT low hold time after RAS low	t _{RDH}	55		65		ns	Note 4
DT low hold time after RAS low	t _{RDHS}	10		25		ns	Note 4
DT low hold time after CAS low	t _{CDH}	15		20		ns	Note 4
DT low hold time after address	t _{ADD}	20		25		ns	Note 4
SC low hold time after DT high	t _{SDH}	40		40		ns	Note 4
SC low hold time after DT high	t _{SDHR}	40		45		ns	Notes 2, 4
SC high to CAS low	t _{SSC}	10		10		ns	Notes 2, 3, 4
SC high to DT high	t _{SDD}	0		0		ns	Note 4
DT high to RAS high delay time	t _{DTR}	0		0		ns	Note 4
Serial input disable time from SC	t _{SIZ}	0		0		ns	
Serial output disable time from RAS	t _{SRZ}	0		0		ns	

- Notes**
1. The t_{SRAS} and t_{SRH} in the hidden refresh cycle, \overline{CAS} before \overline{RAS} refresh cycle (STOP register set cycle and optional reset cycle) are specified to guarantee the serial port operations until the transfer cycle is executed after the STOP register value is changed. When the STOP register value is not to be changed, or when the binary boundary jump function is not used (when the TAP register is empty), t_{SRAS} and t_{SRH} will not be specified.
 2. t_{SSC} (split read data transfer cycle) and t_{SWS} (split write data transfer cycle) are specified at the rising edge of SC which reads/writes the address of the jump source in the binary boundary jump function. t_{SDHR} (split read data transfer cycle and split write data transfer cycle) is specified at the rising edge of SC which reads/writes the address of the jump destination in the binary boundary jump function. The rising edge of these SCs cannot be input in periods (1) and (2).
 - (1) Split read data transfer cycle: Period from the rising edge of the SC specifying t_{SSC} to that of the SC specifying t_{SDHR} (Refer to **Note 2 at the Split Read/Write Data Transfer Cycle Timing Chart.**)
 - (2) Split write data transfer cycle: Period from the rising edge of the SC specifying t_{SWS} to that of the SC specifying t_{SDHR} (Refer to **Note 2 at the Split Read/Write Data Transfer Cycle Timing Chart.**)
 3. Restrictions to the split read data transfer cycle during serial write operation
 - (1) If split read data transfer is attempted for an address which is already involved in serial write, normal operation is not guaranteed, except for a period in which no serial write has been performed, that is from when \overline{SE} goes low at the rising edge of SC to just before the serial write begins.
 - (2) If split read data transfer is attempted when an address involved in serial write is the boundary address specified by the STOP register, normal operation is not guaranteed, except for a period in which no serial write has been performed, that is from just after the mask write or mask split write transfer cycle is executed to just before the serial write is started by setting \overline{SE} to a low level at the rising edge of SC.
 4. One of the following specifications will be valid depending on the type of read data transfer method used.
 - (1) $\overline{DT}/\overline{OE}$ edge control: Satisfy the following specifications.
 - For $\overline{DT}/\overline{OE}$ edge inputs : t_{RDH} , t_{CDH} , t_{ADD} , t_{DTR}
 - For SC inputs : t_{SDD} , t_{SDH}
 - (2) Self control: Satisfy the following specification.
 - For $\overline{DT}/\overline{OE}$ edge inputs : t_{RDHS}
 - For SC inputs : t_{SSC} , t_{SDHR}

Read Data Transfer Cycle (SC Active)

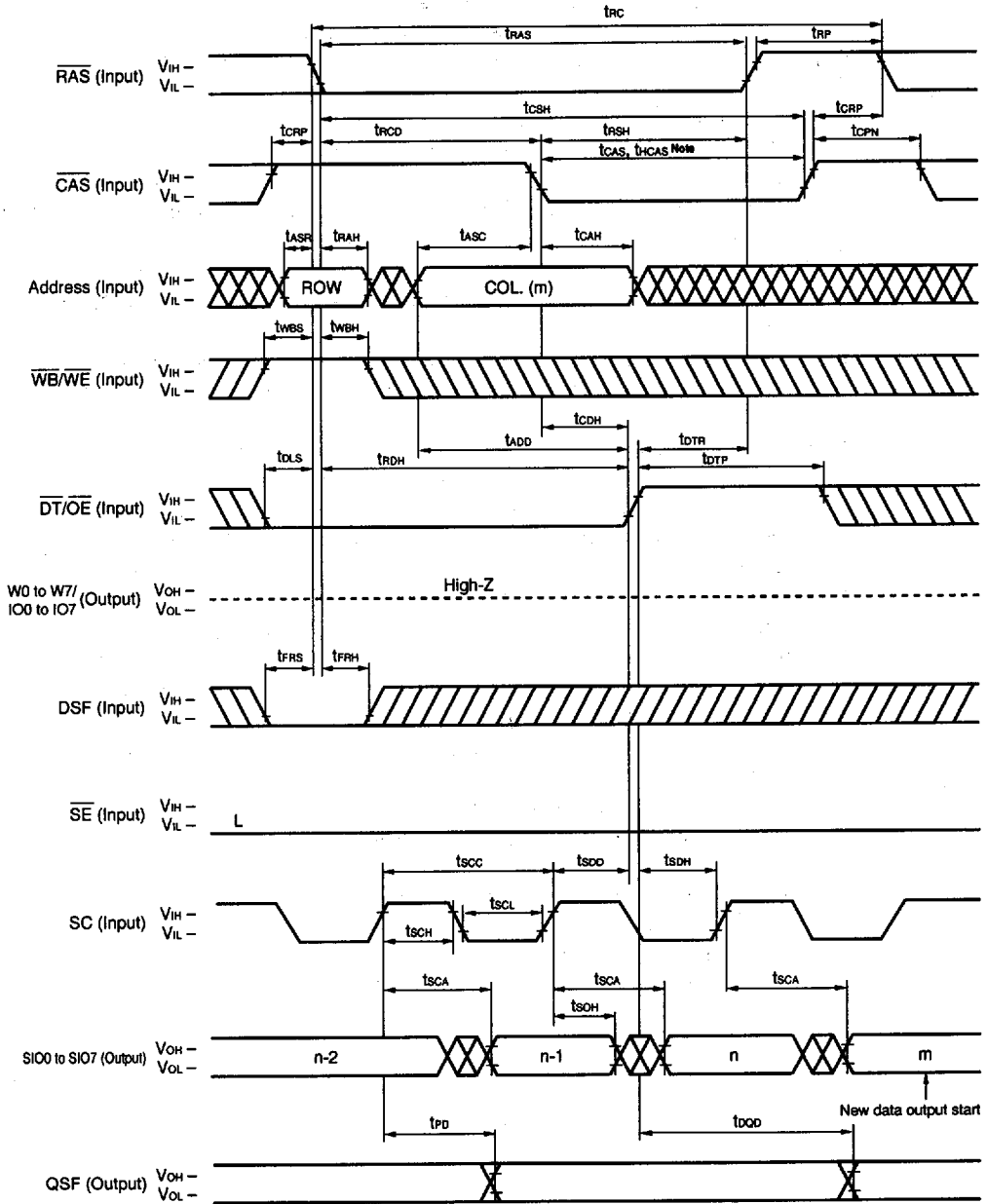

Note t_{CAS} for the μ PD482234
 t_{HCAS} for the μ PD482235

Read Data Transfer Cycle (SC Inactive)

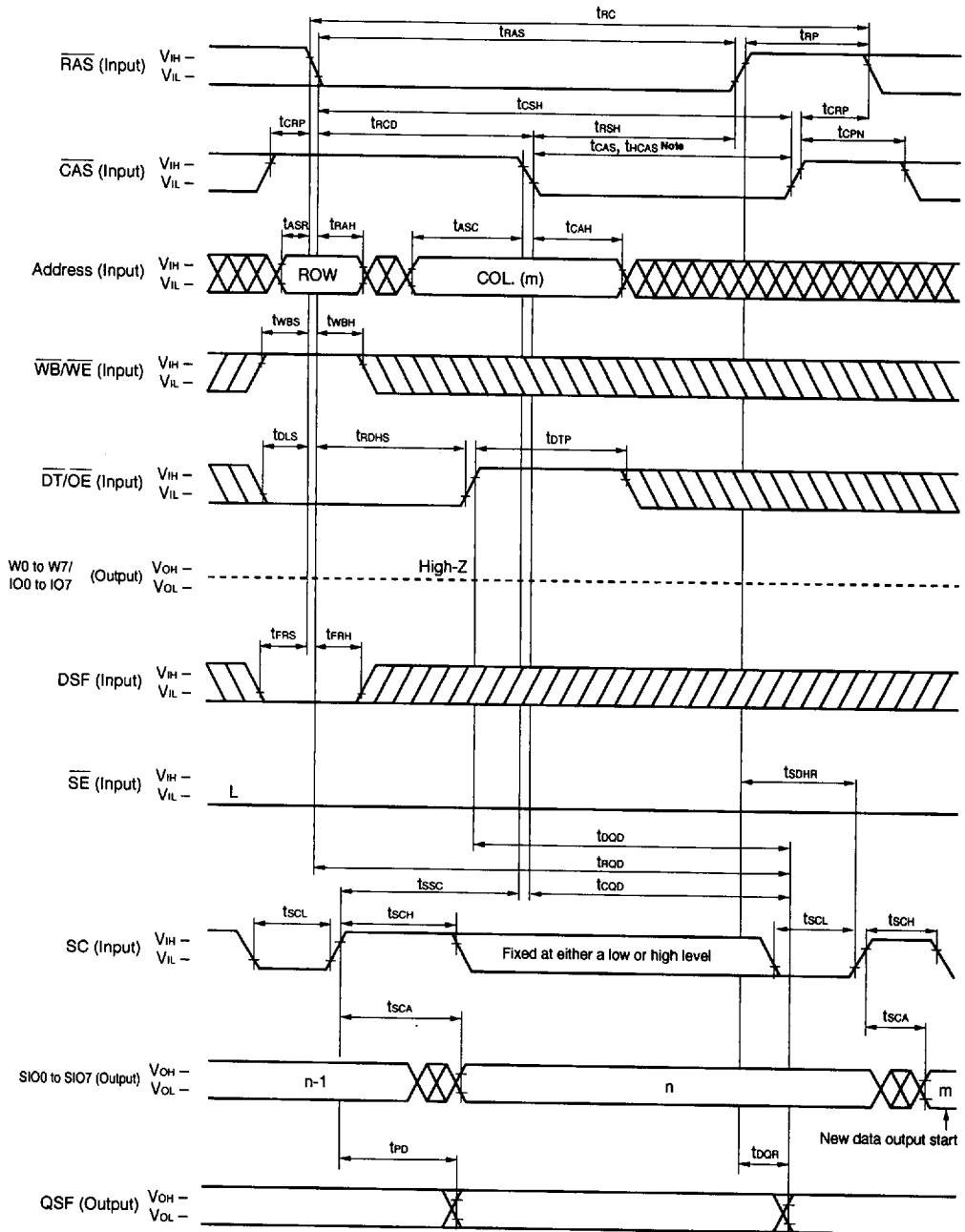

Note t_{CAS} for the μ PD482234
 t_{HCAS} for the μ PD482235

Write Data Transfer Cycle

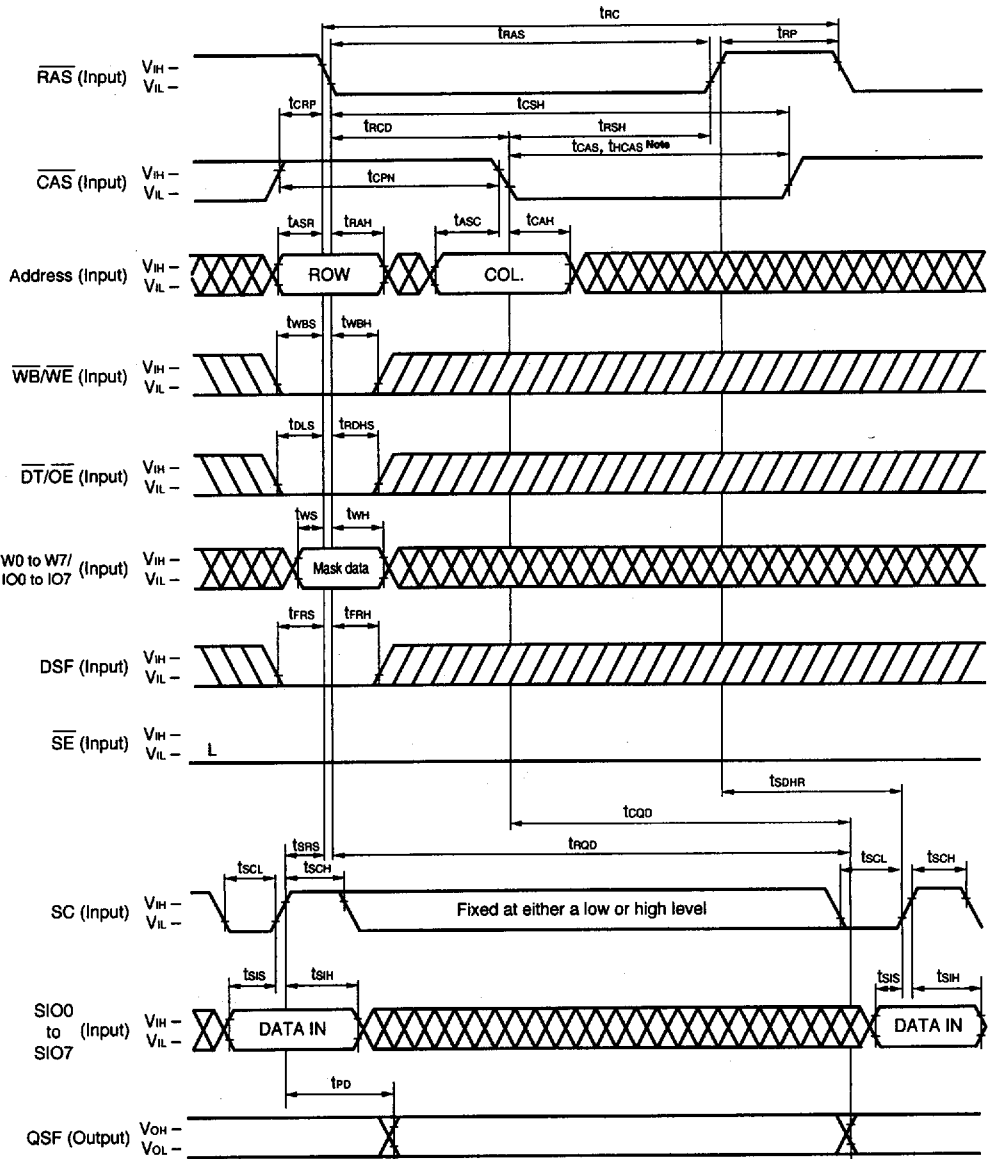

Note t_{CAS} for the μPD482234
 t_{HCAS} for the μPD482235

Split Write Data Transfer Cycle

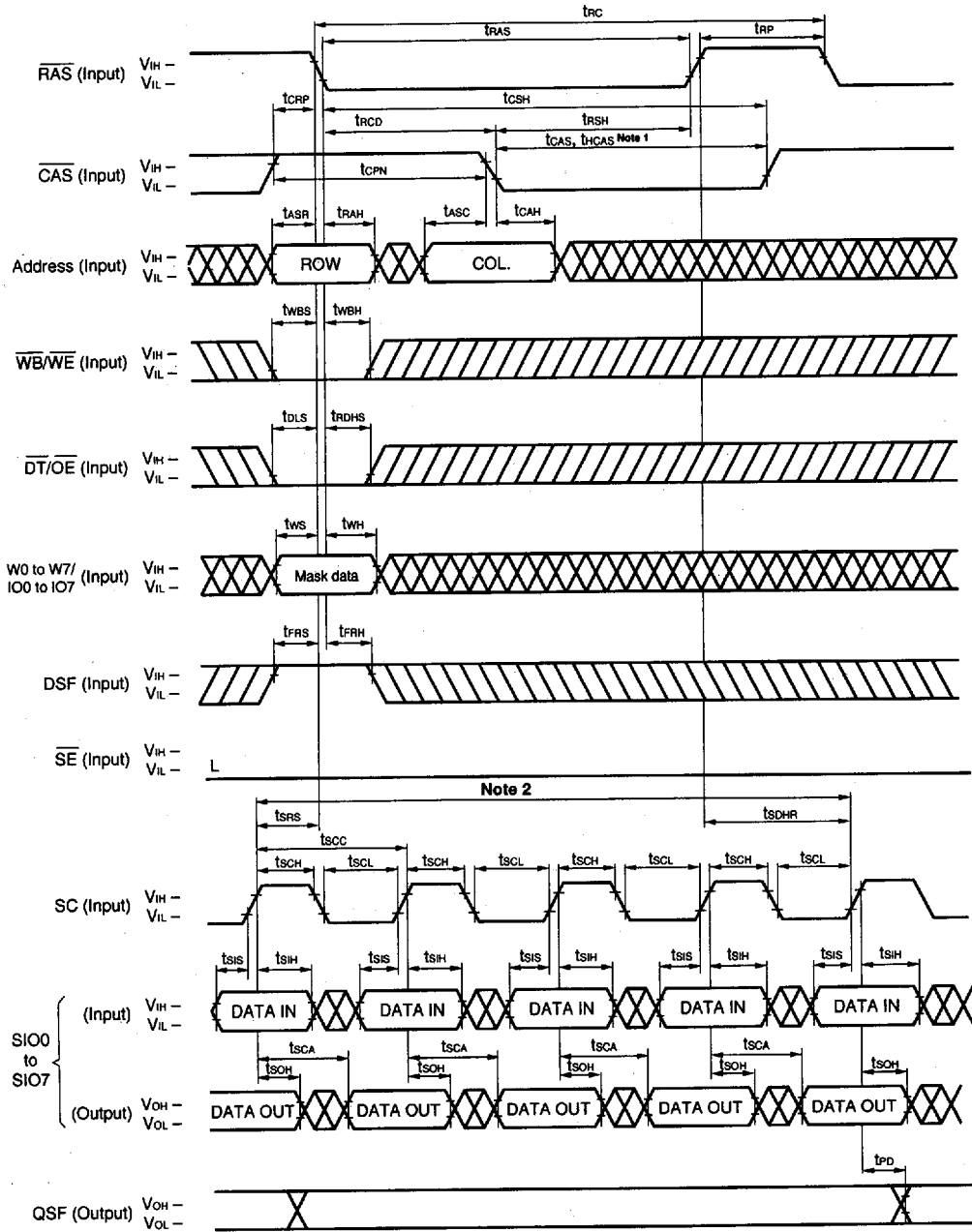

- Notes**
1. tcAS for the μ PD482234
thcAS for the μ PD482235
 2. Do not perform the following two serial read/write during this period.
 - Serial read/write of jump source address set to the STOP register of the data register which does not perform the data transfer cycle.
 - Serial read/write of last address of data register (Address 255 or 511)

(Serial read, write cycle)

Parameter	Symbol	μPD482234-60 μPD482235-60		μPD482234-70 μPD482235-70		Unit	Condition
		MIN.	MAX.	MIN.	MAX.		
Serial clock cycle time	t _{SCC}	18		22		ns	
Serial output access time from \overline{SE}	t _{SEA}		15		17	ns	
Serial output access time from SC	t _{SCA}		15		17	ns	
Propagation delay time from SC to QSF	t _{PD}		20		20	ns	
SC precharge time	t _{SCL}	5		5		ns	
\overline{SE} precharge time	t _{SEP}	5		5		ns	
SC pulse width	t _{SCH}	5		5		ns	
\overline{SE} pulse width	t _{SEE}	5		5		ns	
\overline{SE} setup time	t _{SES}	0		0		ns	
\overline{SE} hold time from SC	t _{SEH}	10		10		ns	
Serial data in setup time	t _{sis}	0		0		ns	
Serial data in hold time	t _{sih}	10		10		ns	
Serial output hold time after SC high	t _{soh}	3		5		ns	
Output disable time from \overline{SE} high	t _{sez}	0	15	0	15	ns	Note
\overline{SE} low to serial output setup delay time	t _{soo}	3		5		ns	

Note t_{sez}, t_{oez}, t_{wesz}, t_{off}, t_{ofr}, and t_{ofc} define the time when the output achieves the condition of high impedance and is not referenced to V_{OH} or V_{OL}.

Serial Read Cycle

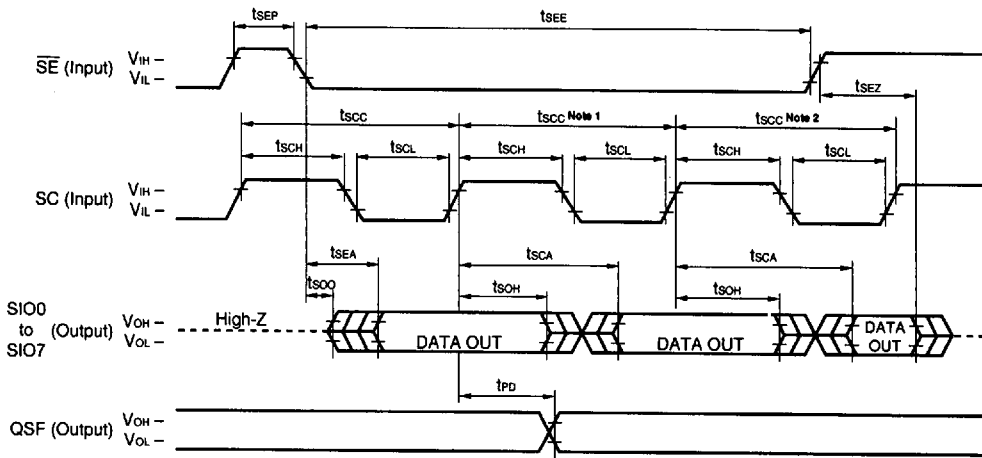

- Notes**
1. Last address of data register (Address 255 or 511)
 2. Starting address of data register newly read (address is specified in the data transfer cycle).

Remark Because the random access port operates independently of the serial access port, there is no need to control the $\overline{\text{RAS}}$, $\overline{\text{CAS}}$, Address, $\overline{\text{WB/WE}}$, $\overline{\text{DT/OE}}$, W/O , DSF pins in this cycle.

Serial Write Cycle

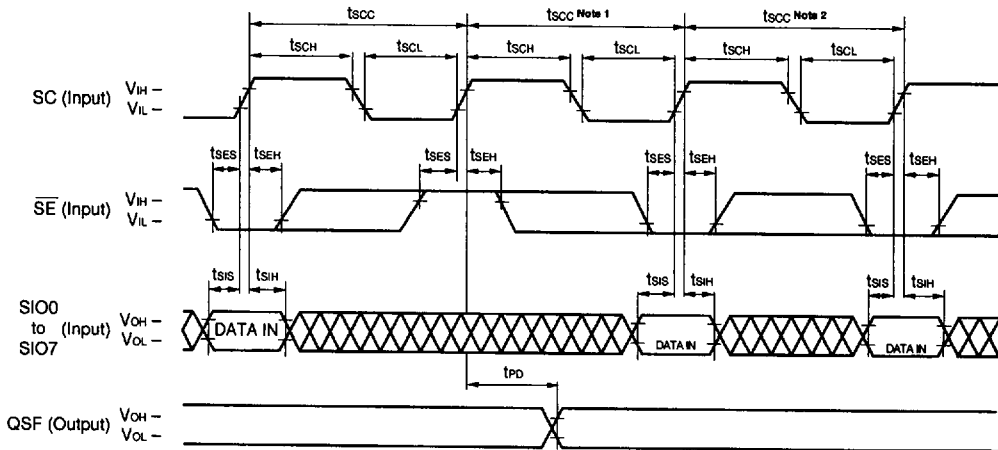

- Notes**
1. Last address of data register (Address 255 or 511)
 2. Starting address of data register newly read (address is specified in the data transfer cycle).

Remark Because the random access port operates independently of the serial access port, there is no need to control the $\overline{\text{RAS}}$, $\overline{\text{CAS}}$, Address, $\overline{\text{WB/WE}}$, $\overline{\text{DT/OE}}$, W/O , DSF pins in this cycle.

5. Package Drawings

40 PIN PLASTIC SOJ (400 mil)

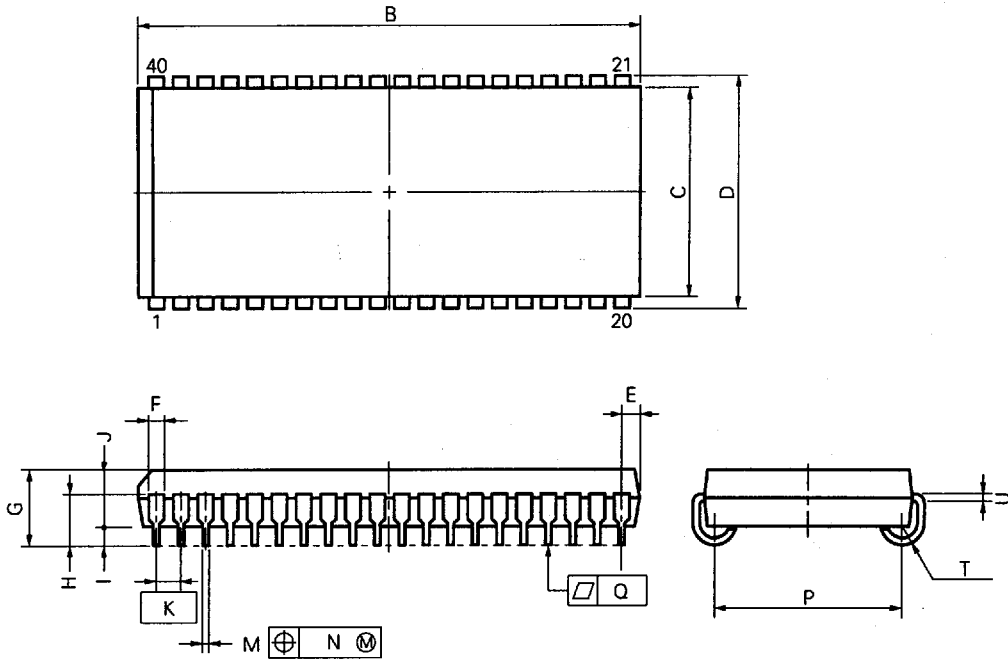

NOTE

Each lead centerline is located within 0.12 mm (0.005 inch) of its true position (T.P.) at maximum material condition.

ITEM	MILLIMETERS	INCHES
B	26.29 ^{+0.2} _{-0.35}	1.035 ^{+0.008} _{-0.014}
C	10.16	0.400
D	11.18±0.2	0.440±0.008
E	1.08±0.15	0.043 ^{+0.006} _{-0.007}
F	0.7	0.028
G	3.5±0.2	0.138±0.008
H	2.4±0.2	0.094 ^{+0.009} _{-0.008}
I	0.8 MIN.	0.031 MIN.
J	2.6	0.102
K	1.27(T.P.)	0.050(T.P.)
M	0.40±0.10	0.016 ^{+0.004} _{-0.005}
N	0.12	0.005
P	9.40±0.20	0.370±0.008
Q	0.15	0.006
T	R0.85	R0.033
U	0.20 ^{+0.10} _{-0.05}	0.008 ^{+0.004} _{-0.002}

P40LE-400A-2

44 PIN PLASTIC TSOP(II) (400 mil)

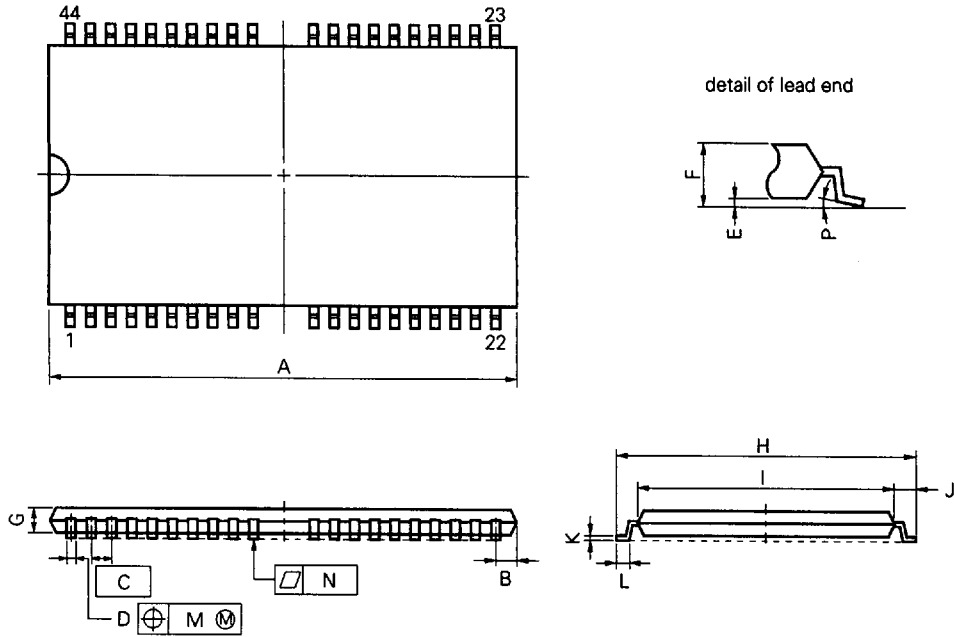

NOTE

Each lead centerline is located within 0.13 mm (0.005 inch) of its true position (T.P.) at maximum material condition.

ITEM	MILLIMETERS	INCHES
A	18.63 MAX.	0.734 MAX.
B	0.93 MAX.	0.037 MAX.
C	0.8 (T.P.)	0.031 (T.P.)
D	0.32 ^{+0.08} _{-0.07}	0.013±0.003
E	0.1±0.05	0.004±0.002
F	1.2 MAX.	0.048 MAX.
G	0.97	0.038
H	11.76±0.2	0.463±0.008
I	10.16±0.1	0.400±0.004
J	0.8±0.2	0.031 ^{+0.009} _{-0.008}
K	0.145 ^{+0.025} _{-0.015}	0.006±0.001
L	0.5±0.1	0.020 ^{+0.004} _{-0.005}
M	0.13	0.005
N	0.10	0.004
P	3°+7° -3°	3°+7° -3°

S44G5-80-7JF4

[MEMO]

PAGE(S) INTENTIONALLY BLANK

6. Recommended Soldering Conditions

Please consult with our sales offices for soldering conditions of the μPD482234, μPD482235.

Types of Surface Mount Device

μPD482234LE-xx : 40-pin plastic SOJ (400 mil)

μPD482235LE-xx : 40-pin plastic SOJ (400 mil)

μPD482234G5-xx : 44-pin plastic TSOP (II) (400 mil)

μPD482235G5-xx : 44-pin plastic TSOP (II) (400 mil)

7. Example of Stamping

Letter B in the fifth character position in a lot number signifies version B, letter A, version A, letter F, version F, and letter E, version E.

