

PBL 3772

Dual Stepper Motor Driver

Description

The PBL 3772 is a switch-mode (chopper), constant-current driver IC with two channels, one for each winding of a two-phase stepper motor. The circuit is similar to Ericsson's PBL 3771, but has been designed to generate a minimum amount of power dissipation and can deliver substantially more current to the stepper motor, up to 1 A continuously per channel. At 2 x 750 mA output current, power dissipation is only 1.8 W.

The circuit is designed for microstepping applications in conjunction with the matching dual DAC (Digital-to-Analog Converter) PBM 3960. A complete driver system consists of these two ICs, a few passive components and a microprocessor for generation of the proper control and data codes required for microstepping.

The PBL 3772 contains a clock oscillator, which is common for both driver channels, a set of comparators and flip-flops implementing the switching control, and two output H-bridges.

Voltage supply requirements are +5 V for logic and +10 to +45 V for the motor.

The close match between the two driver channels guarantees consistent output current ratios and motor positioning accuracy.

Key Features

- Dual chopper driver in a single package.
- 0°C to +85°C operation.
- 1.0 A continuous output current per channel.
- Very low power dissipation, 1.8 W at 2 x 750 mA output current.
- Close matching between channels for high microstepping accuracy.
- Specially matched to the Dual DAC PBM 3960.
- Plastic 22-pin batwing DIP package or 28-pin power PLCC with lead-frame for heat-sinking through PC board copper.

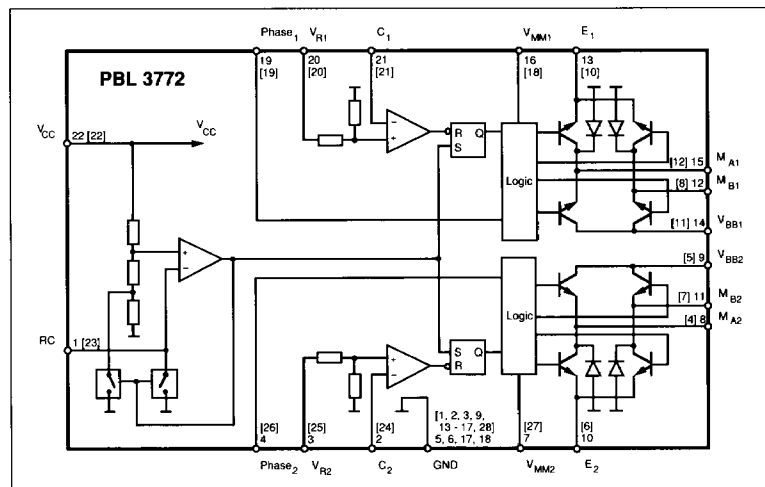
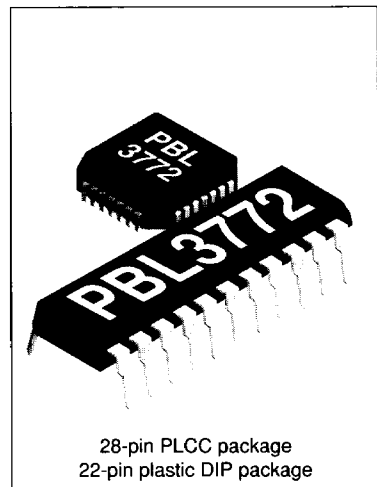

Figure 1. Block diagram.



Maximum Ratings

Parameter	Pin no.*	Symbol	Min	Max	Unit
Voltage					
Logic supply	22 [22]	V_{CC}	0	7	V
Motor supply	7, 16 [18, 27]	V_{MM}	0	45	V
Output stage supply	9, 14 [5, 11]	V_{BB}	0	45	V
Logic inputs	4, 19 [19, 26]	V_I	-0.3	6	V
Comparator inputs	2, 21 [21, 24]	V_C	-0.3	V_{CC}	V
Reference inputs	3, 20 [20, 25]	V_R	-0.3	7.5	V
Current					
Motor output current	8, 11, 12, 15 [4, 7, 8, 12]	I_M	-1200	+1200	mA
Logic inputs	4, 19 [19, 26]	I_I	-10		mA
Analog inputs	2, 3, 20, 21 [20, 21, 24, 25]	I_A	-10		mA
Temperature					
Junction temperature		T_J		+150	°C
Storage temperature		T_S	-55	+150	°C
Power Dissipation (Package Data)					
Power dissipation at $T_{BW} = +25^\circ\text{C}$, DIP and PLCC package		P_D		5	W
Power dissipation at $T_{BW} = +125^\circ\text{C}$, DIP package		P_D		2.2	W
Power dissipation at $T_{BW} = +125^\circ\text{C}$, PLCC package		P_D		2.6	W

* Pin numers in brackets refer to PLCC package.

Recommended Operating Conditions

Parameter	Symbol	Min	Typ	Max	Unit
Logic supply voltage	V_{CC}	4.75	5	5.25	V
Motor supply voltage	V_{MM}	10		40	V
Output stage supply voltage	V_{BB}	$V_{MM} - 0.5$		V_{MM}	V
Motor output current	I_M	-1000		+1000	mA
Operating ambient temperature	T_A	0		+85	°C
Rise and fall time, logic inputs	t_r, t_f			2	μs
Oscillator timing resistor	R_T	2	15	20	kohm

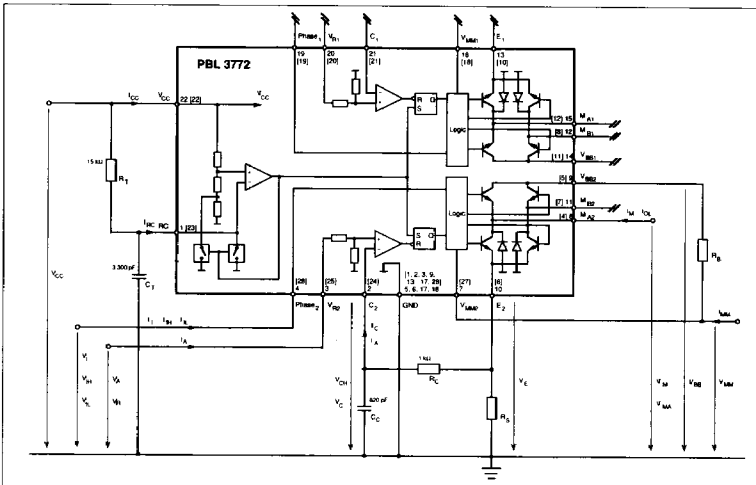

Figure 2. Definition of symbols.

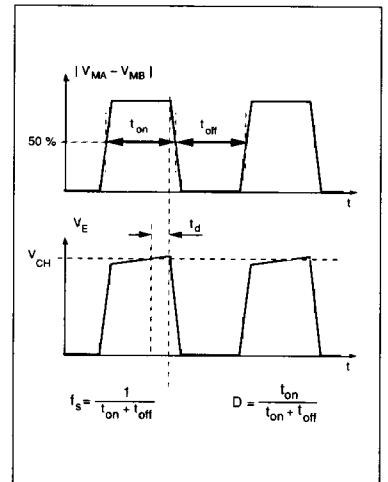

Figure 3. Definition of terms.

Electrical Characteristics

Electrical characteristics over recommended operating conditions, unless otherwise noted. $0^{\circ}\text{C} \leq T_J \leq 125^{\circ}\text{C}$.

Parameter	Symbol	Ref. fig.	Conditions	Min	Typ	Max	Unit
General							
Supply current	I_{CC}	2	Note 4.		60	75	mA
Total power dissipation	P_D	8	$V_{MM} = 12\text{ V}$, $I_{M1} = I_{M2} = 750\text{ mA}$, $R_B = 0.68\text{ ohm}$. Notes 2, 3, 4, 5.		1.8	2.1	W
Total power dissipation	P_D	8	$V_{MM} = 12\text{ V}$, $I_{M1} = 1000\text{ mA}$, $I_{M2} = 0\text{ mA}$, $R_B = 0.47\text{ ohm}$. Notes 2, 3, 4, 5.		1.8	2.2	W
Thermal shutdown junction temperature					160		$^{\circ}\text{C}$
Turn-off delay	t_d	3	$T_A = +25^{\circ}\text{C}$, $dV/dt \geq 50\text{ mV}/\mu\text{s}$, $I_M = 100\text{ mA}$. Note 3.		1.4	2.0	μs

Logic Inputs

Logic HIGH input voltage	V_{IH}	2		2.0			V
Logic LOW input voltage	V_{IL}	2				0.8	V
Logic HIGH input current	I_{IH}	2	$V_I = 2.4\text{ V}$			20	μA
Logic LOW input current	I_{IL}	2	$V_I = 0.4\text{ V}$	-0.4			mA

Comparator Inputs

Threshold voltage	V_{CH}	2	$R_C = 1\text{ kohm}$, $V_R = 2.50\text{ V}$	430	450	470	mV
$ V_{CH1} - V_{CH2} $ mismatch	$V_{CH,diff}$	2	$R_C = 1\text{ kohm}$		1		mV
Input current	I_C	2		-10		1	μA

Reference Inputs

Input resistance	R_R		$T_A = +25^{\circ}\text{C}$		5		kohm
Input current	I_R	2	$V_R = 2.50\text{ V}$		0.5	1.0	mA

Motor Outputs

Lower transistor saturation voltage		11	$I_M = 750\text{ mA}$		0.6	0.9	V
Lower transistor leakage current		2	$V_{MM} = 41\text{ V}$, $V_E = V_R = 0\text{ V}$, $V_C = V_{CC}$			700	μA
Lower diode forward voltage drop		12	$I_M = 750\text{ mA}$		1.2	1.5	V
Upper transistor saturation voltage		13	$I_M = 750\text{ mA}$, $R_B = 0.68\text{ ohm}$. Note 5.		0.6	0.9	V
Upper transistor saturation voltage		13	$I_M = 750\text{ mA}$, $R_B = 0.47\text{ ohm}$. Note 3, 5.		0.8	1.1	V
Upper transistor leakage current		2	V_{MM} , $V_{BB} = 41\text{ V}$, $V_E = V_R = 0\text{ V}$, $V_C = V_{CC}$			700	μA

Chopper Oscillator

Chopping frequency	f_s	3	$C_T = 3300\text{ pF}$, $R_T = 15\text{ kohm}$	25.0	26.5	28.0	kHz
--------------------	-------	---	---	------	------	------	-----

Thermal Characteristics

Parameter	Symbol	Ref. fig.	Conditions	Min	Typ	Max	Unit
Thermal resistance	$R_{th,J-BW}$		DIP package.		11		$^{\circ}\text{C}/\text{W}$
	$R_{th,J-A}$	14	DIP package. Note 2.		40		$^{\circ}\text{C}/\text{W}$
	$R_{th,J-BW}$		PLCC package.		9		$^{\circ}\text{C}/\text{W}$
	$R_{th,J-A}$	14	PLCC package. Note 2.		35		$^{\circ}\text{C}/\text{W}$

Notes

- All voltages are with respect to ground. Currents are positive into, negative out of specified terminal.
- All ground pins soldered onto a 20 cm^2 PCB copper area with free air convection, $T_A = +25^{\circ}\text{C}$.
- Not covered by final test program.
- Switching duty cycle $D = 30\%$, $f_s = 26.5\text{ kHz}$.
- External resistors R_B for lowering of saturation voltage.

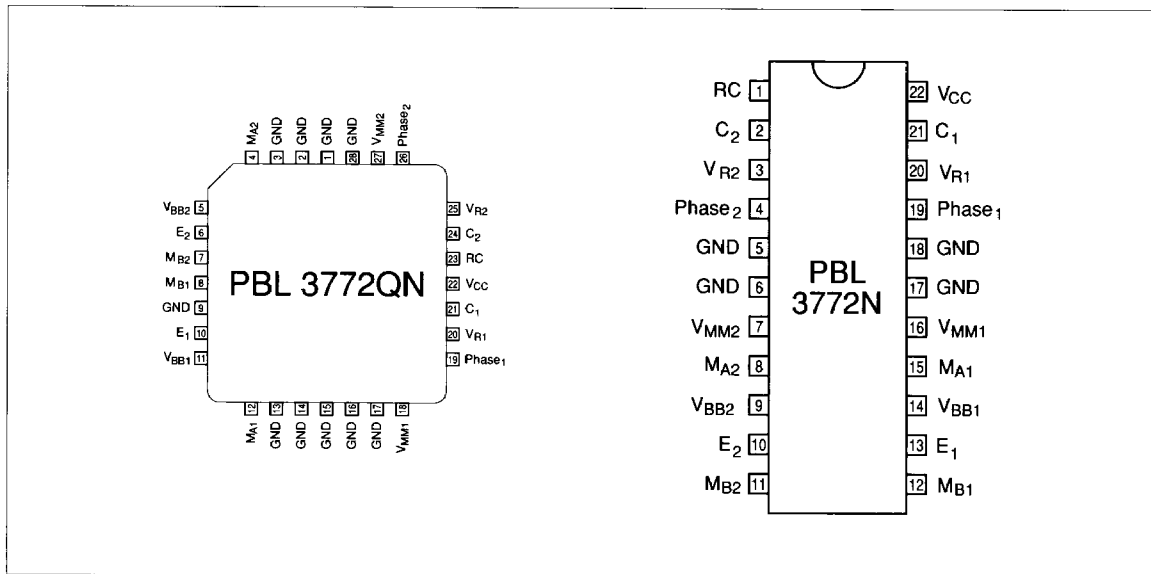

Figure 4. Pin configuration.

Pin Description

PLCC	DIP	Symbol	Description
[1-3, 9, 5, 6 13-17 28]	17, 18	GND	Ground and negative supply. Note: these pins are used thermally for heat-sinking. Make sure that all ground pins are soldered onto a suitably large copper ground plane for efficient heat sinking.
[4]	8	M _{A2}	Motor output A, channel 2. Motor current flows from M _{A2} to M _{B2} when Phase ₂ is HIGH.
[5]	9	V _{BB2}	Collector of upper output transistor, channel 2. For lowest possible power dissipation, connect a series resistor R _B to V _{MM} . See Applications information, External components.
[6]	10	E ₂	Common emitter, channel 2. This pin connects to a sensing resistor R _S to ground.
[7]	11	M _{B2}	Motor output B, channel 2. Motor current flows from M _{A2} to M _{B2} when Phase ₂ is HIGH.
[8]	12	M _{B1}	Motor output B, channel 1. Motor current flows from M _{A1} to M _{B1} when Phase ₁ is HIGH.
[10]	13	E ₁	Common emitter, channel 1. This pin connects to a sensing resistor R _S to ground.
[11]	14	V _{BB1}	Collector of upper output transistor, channel 1. For lowest possible power dissipation, connect a series resistor R _B to V _{MM} . See Applications information, External components.
[12]	15	M _{A1}	Motor output A, channel 1. Motor current flows from M _{A1} to M _{B1} when Phase is HIGH.
[18]	16	V _{MM1}	Motor supply voltage, channel 1, +10 to +40 V. V _{MM1} and V _{MM2} should be connected together.
[19]	19	Phase ₁	Controls the direction of motor current at outputs M _{A1} and M _{B1} . Motor current flows from M _{A1} to M _{B1} when Phase ₁ is HIGH.
[20]	20	V _{R1}	Reference voltage, channel 1. Controls the threshold voltage for the comparator and hence the output current.
[21]	21	C ₁	Comparator input channel 1. This input senses the instantaneous voltage across the sensing resistor, filtered by an RC network. The threshold voltage for the comparator is V _{CH1} = 0.18 • V _{R1} [V], i.e. 450 mV at V _{R1} = 2.5 V.
[22]	22	V _{CC}	Logic voltage supply, nominally +5 V.
[23]	1	RC	Clock oscillator RC pin. Connect a 15 kohm resistor to V _{CC} and a 3300 pF capacitor to ground to obtain the nominal switching frequency of 26.5 kHz.
[24]	2	C ₂	Comparator input channel 2. This input senses the instantaneous voltage across the sensing resistor, filtered by an RC network. The threshold voltage for the comparator is V _{CH2} = 0.18 • V _{R2} [V], i.e. 450 mV at V _{R2} = 2.5 V.

[25]	3	V_{R2}	Reference voltage, channel 2. Controls the threshold voltage for the comparator and hence the output current.
[26]	4	Phase ₂	Controls the direction of motor current at outputs M_{A2} and M_{B2} . Motor current flows from M_{A2} to M_{B2} when Phase ₂ is HIGH.
[27]	7	V_{MM2}	Motor supply voltage, channel 2, +10 to +40 V. V_{MM1} and V_{MM2} should be connected together.

Functional Description

Each channel of the PBL 3772 consists of the following sections: an output H-bridge with four transistors, capable of driving up to 1 A continuous current to the motor winding; a logic section that controls the output transistors; an S-R flip-flop; and a comparator. The clock-oscillator is common to both channels.

Constant current control is achieved by switching the output current to the windings. This is done by sensing the peak current through the winding via a current-sensing resistor R_S , effectively connected in series with the motor winding during the turn-on period. As the current increases, a voltage develops across the

sensing resistor, which is fed back to the comparator. At the predetermined level, defined by the voltage at the reference input V_R , the comparator resets the flip-flop, which turns off the output transistors. The current decreases until the clock oscillator triggers the flip-flop, which turns on the output transistors again, and the cycle is repeated.

The current paths during turn-on, turn-off and phase shift are shown in figure 5. Note that the upper recirculation diodes are connected to the circuit externally.

winding is determined by the voltage at the reference input and the sensing resistor, R_S .

Chopping frequency, winding inductance and supply voltage also affect the current, but to much less extent.

The peak current through the sensing resistor (and motor winding) can be expressed as:

$$I_{M,peak} = 0.18 \cdot (V_R / R_S) \quad [A]$$

i.e., with a recommended value of 0.47 ohm for the sensing resistor R_S , a 2.5 V reference voltage will produce an output current of approximately 0.96 A. To improve noise immunity on the V_R input, the control range may be increased to 5 V if R_S is correspondingly changed to 1 ohm.

Applications Information

Current control

The output current to the motor

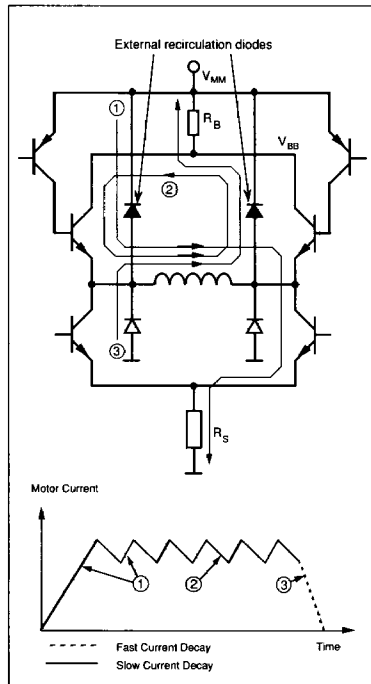

Figure 5. Output stage with current paths during turn-on, turn-off and phase shift.

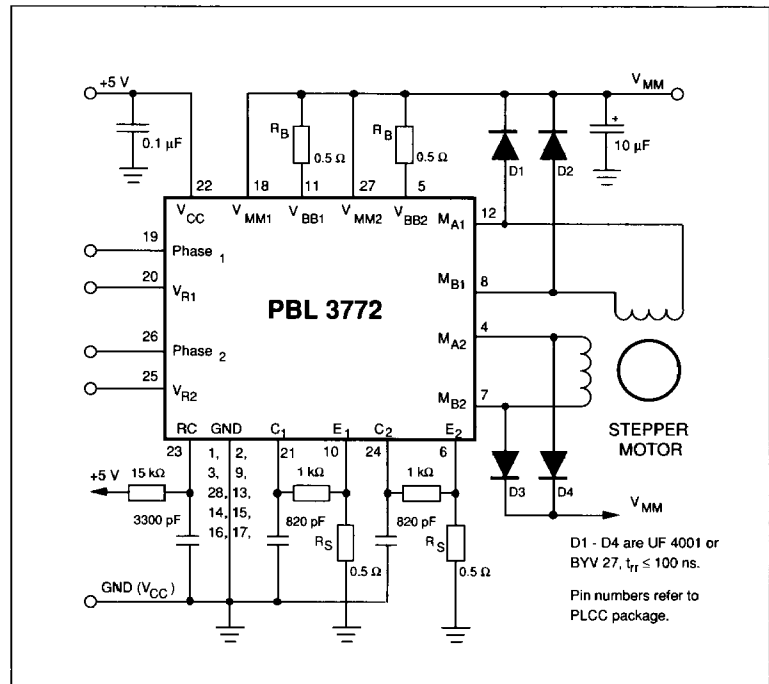

Figure 6. Typical stepper motor driver application with PBL 3772.

External components

The PBL 3772 exhibits substantially less power dissipation than most other comparable stepper motor driver ICs on the market. This has been achieved by creating an external voltage drop in series with the upper transistor in the output H-bridge, see figure 5. The voltage drop reduces the collector-emitter saturation voltage of the internal transistor, which can greatly reduce power dissipation of the IC itself. The series resistor, designated R_B , shall be selected for about 0.5 V voltage drop at the maximum output current. In an application with an output current of 1000 mA (peak), a 0.47 ohm, 1/2 W resistor is the best choice.

In low current applications where power dissipation is not a critical factor, the R_B resistor can of course be omitted, and the V_{MM} and V_{BB} pins (pins 5, 11, 18, 27) can all be connected directly to the motor supply voltage V_{MM} .

Contributing to the low power dissipation is the fact that the upper recirculation diodes in the output H-

bridge are connected externally to the circuit. These diodes shall be of fast type, with a t_{rr} of less than 100 ns. Common types are UF4001 or BYV27.

A low pass filter in series with the comparator input prevents erroneous switching due to switching transients. The recommended filter component values, 1 kohm and 820 pF, are suitable for a wide range of motors and operational conditions.

Since the low-pass filtering action introduces a small delay of the signal to the comparator, peak voltage across the sensing resistor, and hence the peak motor current, will reach a slightly higher level than what is defined by the comparator threshold, V_{CH} , set by the reference input V_R ($V_{CH} = 450$ mV at $V_R = 2.5$ V).

The time constant of the low-pass filter may therefore be reduced to minimize the delay and optimize low-current performance. Increasing the time constant may result in unstable switching. The time constant should be adjusted by

changing the C_C value.

The frequency of the clock oscillator is set by the R_T - C_T timing components at the RC pin. The recommended values result in a clock frequency (= switching frequency) of 26.5 kHz. A lower frequency will result in higher current ripple, but may improve low-current level linearity. A higher clock frequency reduces current ripple, but increases the switching losses in the IC and possibly the iron losses in the motor. If the clock frequency needs to be changed, the C_T capacitor value should be adjusted. The recommended R_T resistor value is 15 kohm.

The sensing resistor R_S , should be selected for maximum motor current. The relationship between peak motor current, reference voltage and the value of R_S is described under Current control above. Be sure not to exceed the maximum output current which is 1.2 A peak when only one channel is activated. Or recommended output current, which is 1.0 A peak, when both channels is activated.

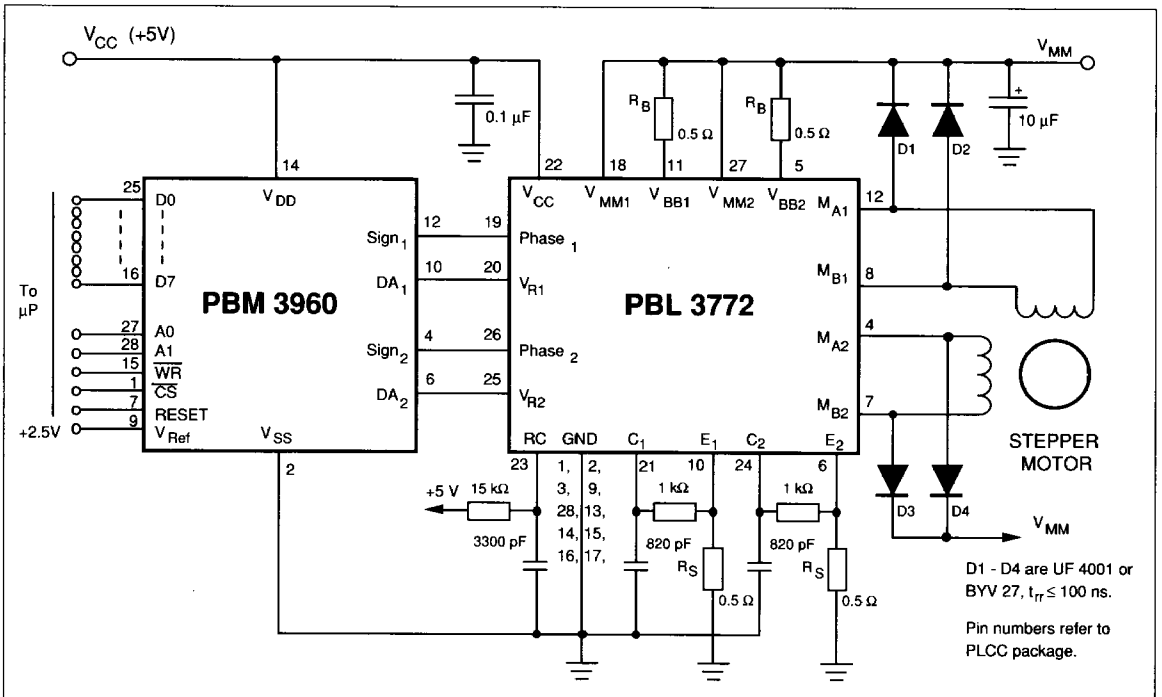

Figure 7. Microstepping system with PBM 3960 and PBL 3772.

Motor selection

The PBL 3772 is designed for two-phase bipolar stepper motors, i.e., motors that have only one winding per phase.

The chopping principle of the PBL 3772 is based on a constant frequency and a varying duty cycle. This scheme imposes certain restrictions on motor selection. Unstable chopping can occur if the chopping duty cycle exceeds approximately 50%. See figure 3 for definitions. To avoid this, it is necessary to choose a motor with a low winding resistance and inductance, i.e. windings with a few turns.

It is not possible to use a motor that is rated for the same voltage as the actual supply voltage. Only rated current needs to be considered. Typical motors to be used together with the PBL 3772 have a voltage rating of 1 to 6 V, while the supply voltage usually ranges from 12 to 40 V.

Low inductance, especially in combination with a high supply voltage, enables high stepping rates. However, to give the same torque capability at low speed, a reduced number of turns in the winding must be compensated by a higher current. A compromise has to be made.

Choose a motor with the lowest possible winding resistance that still gives the required torque, and use as high supply voltage as possible, without exceeding the maximum recommended 40 V. Check that the chopping duty cycle does not exceed 50% at maximum current.

General

Phase inputs. A logic HIGH on a Phase input gives a current flowing from pin M_A into pin M_B . A logic LOW gives a current flow in the opposite direction. A time delay prevents cross conduction in the H-bridge when changing the Phase input.

Heat sinking. Soldering the batwing ground leads onto a copper ground plane of 20 cm² (approx. 1.8" x 1.8"), copper foil thickness 35 μm, permits the circuit to operate with 750 mA output current, both channels driving, at ambient

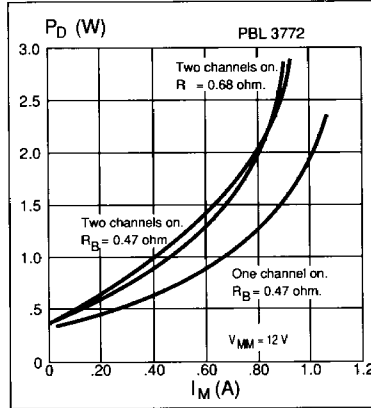

Figure 8. Power dissipation vs. motor current. $T_a = 25^\circ\text{C}$.

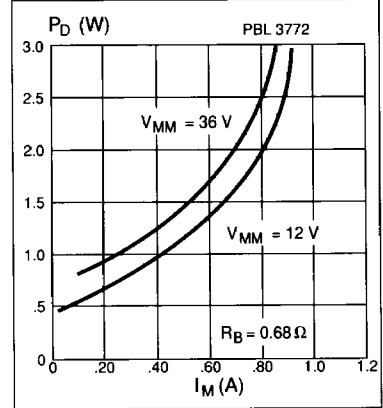

Figure 9. Power dissipation vs. motor current, both channels on. $T_a = 25^\circ\text{C}$.

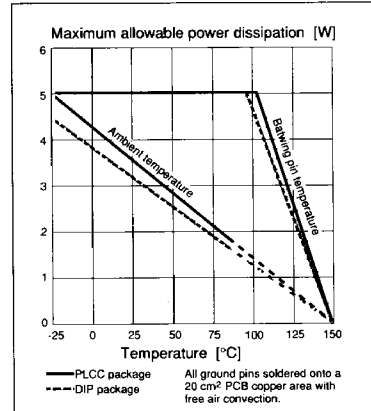

Figure 10. Maximum allowable power dissipation vs. temperature.

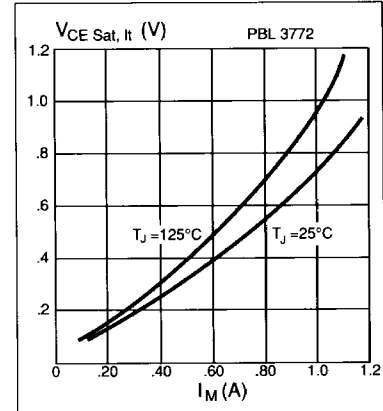

Figure 11. Typical lower transistor saturation voltage vs. output current.

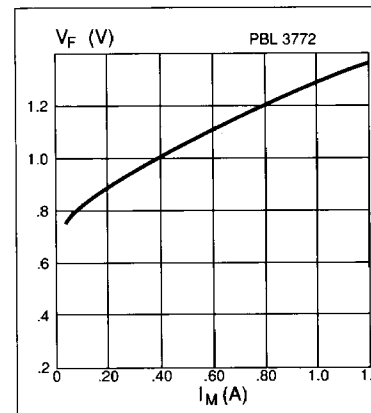

Figure 12. Typical lower diode voltage drop vs. recirculating current.

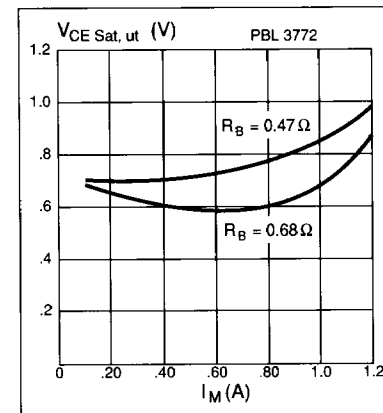

Figure 13. Typical upper transistor saturation voltage vs. output current.

temperatures up to 70°C. Consult figures 8, 9, 10 and 14 in order to determine the necessary copper ground plane area for heat sinking at higher current levels.

Thermal shutdown. The circuit is equipped with a thermal shutdown function that turns the output off at chip temperatures above 160°C. Normal operation is resumed when the temperature has decreased about 20°C.

Ordering Information

Package	Temp. range	Part No.
Plastic DIP	0°C to + 85°C	PBL3772N
PLCC	0°C to + 85°C	PBL3772QN

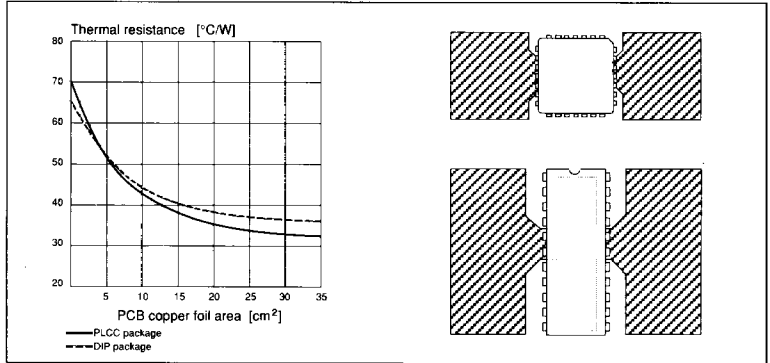

Figure 14. Typical thermal resistance vs. PC Board copper area and suggested layout.

Information given in this data sheet is believed to be accurate and reliable. However no responsibility is assumed for the consequences of its use nor for any infringement of patents or other rights of third parties which may result from its use. No license is granted by implication or otherwise under any patent or patent rights of Ericsson Components. These products are sold only according to Ericsson Components' general conditions of sale, unless otherwise confirmed in writing.

Specifications subject to change without notice.

IC4(89016) B-Ue

Revised edition April 1991.

© Ericsson Components AB 1991

T-90-20

5-lead TO-220

dim.	millimeters		inches	
	min.	max.	min.	max.
A	3.53	3.91	0.139	0.154
B	9.66	10.66	0.380	0.420
C	3.55	4.80	0.140	0.189
D	1.05	1.39	0.041	0.055
E	2.04	2.92	0.080	0.155
F	0.38	0.50	0.015	0.020
G	2.54	3.05	0.100	0.120
H		3.00		0.118
I	1.50	1.90	0.059	0.075
J	12.50	14.50	0.492	0.571
K	14.32	15.52	0.564	0.611
L	0.81	0.95	0.032	0.037
M	5.85	6.85	0.230	0.270

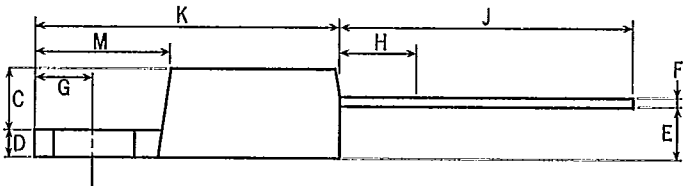
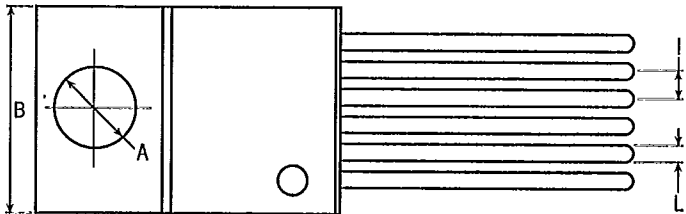
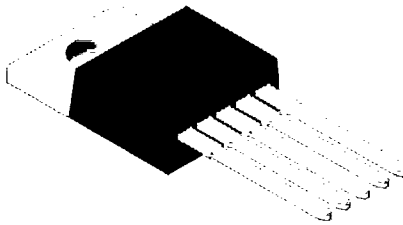

16-lead small outline package

dim.	millimeters		inches	
	min.	max.	min.	max.
A	2.35	2.65	0.093	0.104
B	0.33	0.51	0.013	0.020
C	0.23	0.32	0.009	0.012
D	1.27	typical	0.050	typical
E	7.40	7.60	0.291	0.299
F	10.00	10.65	0.394	0.419
G	0.40	1.27	0.016	0.050
H	10.10	10.50	0.397	0.460
I	0.66		0.026	

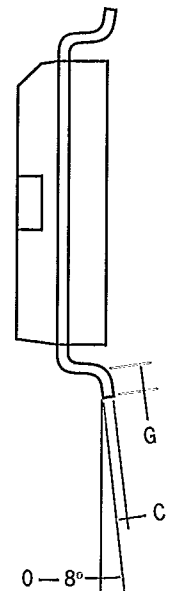
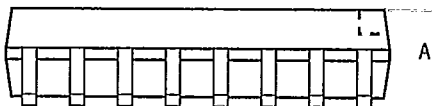
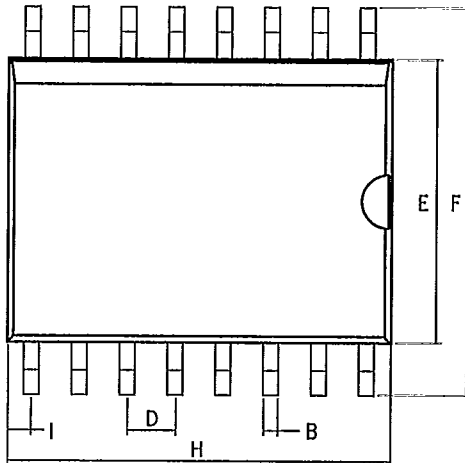
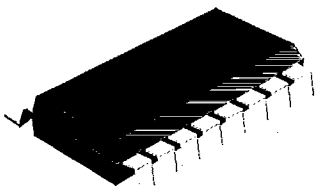

T-90-20

16-pin dual in-line package

dim.	millimeters		inches	
	min.	max.	min.	max.
A	0.39		0.015	
B	0.13		0.005	
C	0.36	0.56	0.014	0.022
D	2.54 typical		0.100 typical	
E		5.33		0.210
F	2.93	4.06	0.115	0.160
G	7.62	8.25	0.300	0.325
H	0.20	0.38	0.008	0.015
I	18.93	21.33	0.745	0.840
J	6.10	7.11	0.240	0.280
K	2.93	4.95	0.115	0.195
L		10.92		0.430
M	1.15	1.77	0.045	0.070

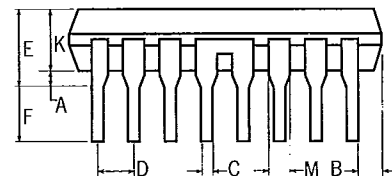
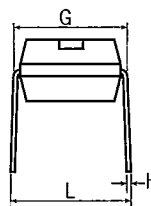
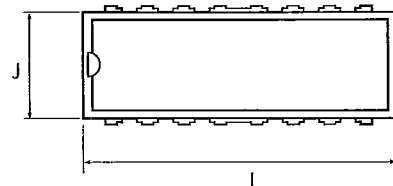
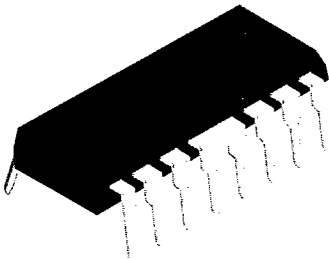
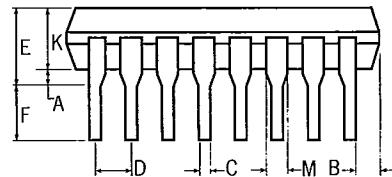
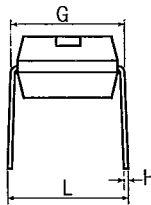
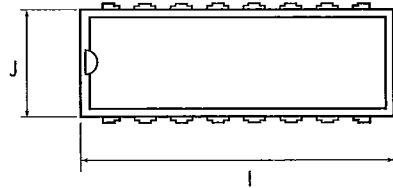
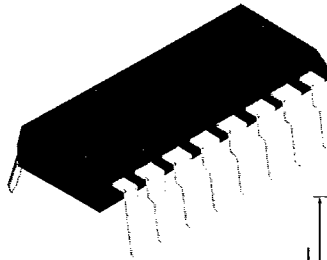

22-pin dual in-line package

T-90-20

dim.	millimeters		inches	
	min.	max.	min.	max.
A	0.39		0.015	
B	0.13		0.005	
C	0.36	0.56	0.014	0.022
D	2.54	typical	0.100	typical
E		5.33		0.210
F	2.93	4.06	0.115	0.160
G	9.91	10.79	0.390	0.425
H	0.20	0.38	0.008	0.015
I	26.67	28.44	1.050	1.120
J	8.39	9.65	0.330	0.380
K	3.18	4.95	0.125	0.195
L		12.70		0.500
M	0.77	1.77	0.030	0.070
N	0.56	1.17	0.022	0.046

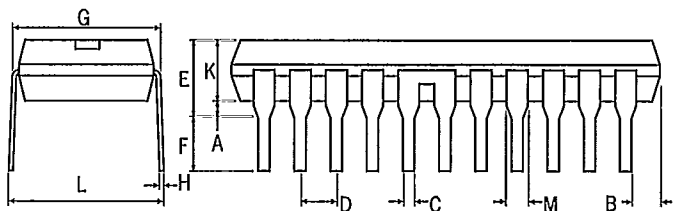
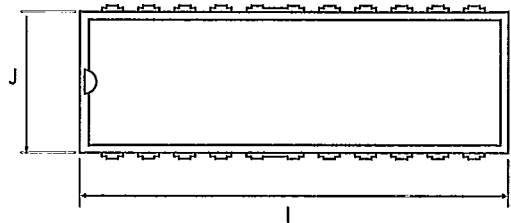
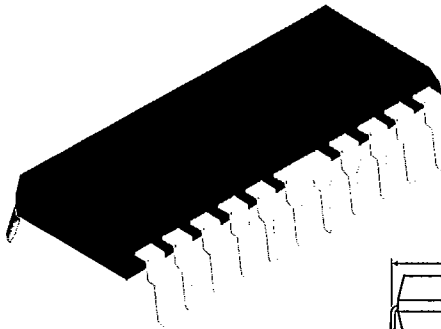
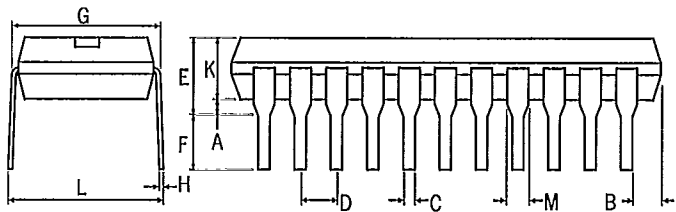
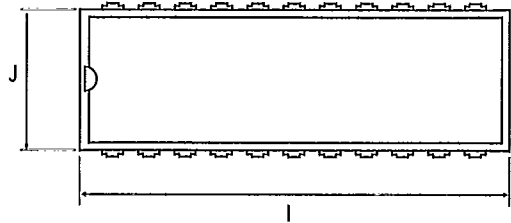
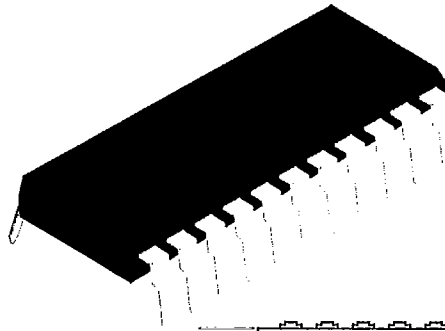

T-90-20

24-pin dual in-line package

dim.	millimeters		inches	
	min.	max.	min.	max.
A	0.39		0.015	
B	0.13		0.005	
C	0.36	0.56	0.014	0.022
D	2.54	typical	0.100	typical
E		5.33		0.210
F	2.93	4.06	0.115	0.160
G	7.62	8.25	0.300	0.325
H	0.20	0.38	0.008	0.015
I	28.60	32.30	1.125	1.275
J	6.10	7.11	0.240	0.280
K	2.93	4.95	0.115	0.195
L		10.92		0.430
M	1.15	1.77	0.045	0.070

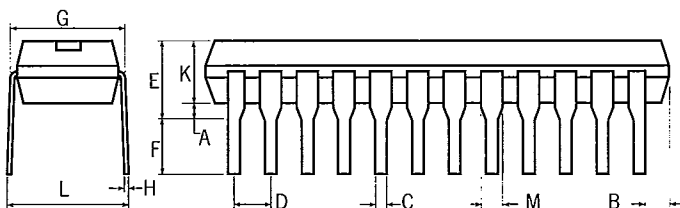
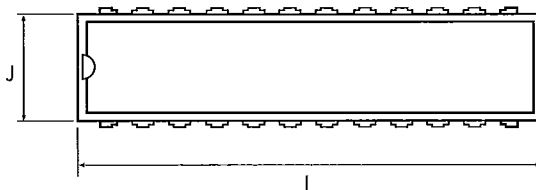
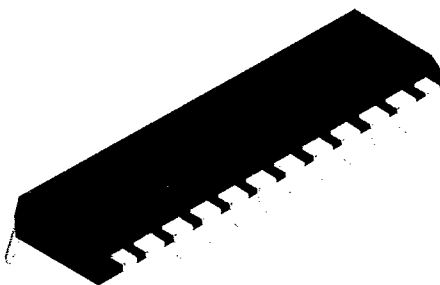

28-lead PLCC package

dim.	millimeters		inches	
	min.	max.	min.	max.
A	12.32	12.57	0.485	0.495
B	11.43	11.58	0.450	0.456
C	0.66	0.81	0.026	0.032
D	2.29	3.04	0.090	0.120
E	9.91	10.92	0.390	0.430
F	4.20	4.57	0.165	0.180
G	1.27 typical		0.050 typical	
I	0.51		0.020	
J	0.33	0.53	0.013	0.027

