

# Amplifier Transistors

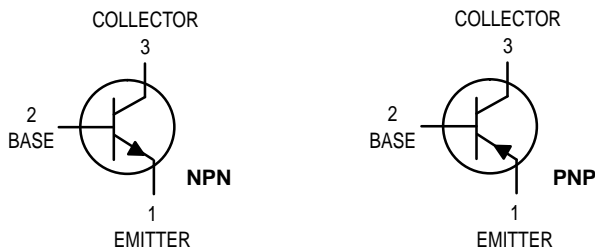

**NPN**  
**MPSA05**  
**MPSA06\***  
**PNP**  
**MPSA55**  
**MPSA56\***

Voltage and current are negative  
for PNP transistors

\*Motorola Preferred Device

## MAXIMUM RATINGS

Rating	Symbol	MPSA05 MPSA55	MPSA06 MPSA56	Unit
Collector–Emitter Voltage	$V_{CEO}$	60	80	Vdc
Collector–Base Voltage	$V_{CBO}$	60	80	Vdc
Emitter–Base Voltage	$V_{EBO}$	4.0		Vdc
Collector Current – Continuous	$I_C$	500		mAdc
Total Device Dissipation @ $T_A = 25^\circ\text{C}$ Derate above $25^\circ\text{C}$	$P_D$	625	5.0	mW mW/°C
Total Device Dissipation @ $T_C = 25^\circ\text{C}$ Derate above $25^\circ\text{C}$	$P_D$	1.5	12	Watts mW/°C
Operating and Storage Junction Temperature Range	$T_J, T_{stg}$	–55 to +150		°C

## THERMAL CHARACTERISTICS

Characteristic	Symbol	Max	Unit
Thermal Resistance, Junction to Ambient	$R_{\theta JA}^{(1)}$	200	°C/W
Thermal Resistance, Junction to Case	$R_{\theta JC}$	83.3	°C/W

## ELECTRICAL CHARACTERISTICS ( $T_A = 25^\circ\text{C}$ unless otherwise noted)

Characteristic	Symbol	Min	Max	Unit
----------------	--------	-----	-----	------

## OFF CHARACTERISTICS

Collector–Emitter Breakdown Voltage <sup>(2)</sup> ( $I_C = 1.0 \text{ mAdc}, I_B = 0$ )	MPSA05, MPSA55 MPSA06, MPSA56	$V_{(BR)CEO}$	60 80	— —	Vdc
Emitter–Base Breakdown Voltage ( $I_E = 100 \mu\text{Adc}, I_C = 0$ )		$V_{(BR)EBO}$	4.0	—	Vdc
Collector Cutoff Current ( $V_{CE} = 60 \text{ Vdc}, I_B = 0$ )		$I_{CES}$	—	0.1	$\mu\text{Adc}$
Collector Cutoff Current ( $V_{CB} = 60 \text{ Vdc}, I_E = 0$ ) ( $V_{CB} = 80 \text{ Vdc}, I_E = 0$ )	MPSA05, MPSA55 MPSA06, MPSA56	$I_{CBO}$	— —	0.1 0.1	$\mu\text{Adc}$

- $R_{\theta JA}$  is measured with the device soldered into a typical printed circuit board.
- Pulse Test: Pulse Width  $\leq 300 \mu\text{s}$ , Duty Cycle  $\leq 2.0\%$ .

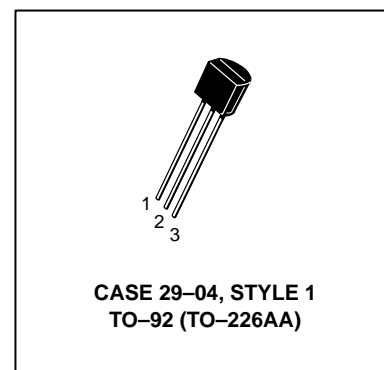

Preferred devices are Motorola recommended choices for future use and best overall value.

# NPN MPSA05 MPSA06 PNP MPSA55 MPSA56

## ELECTRICAL CHARACTERISTICS ( $T_A = 25^\circ\text{C}$ unless otherwise noted) (Continued)

Characteristic	Symbol	Min	Max	Unit
<b>ON CHARACTERISTICS</b>				
DC Current Gain ( $I_C = 10\text{ mAdc}$ , $V_{CE} = 1.0\text{ Vdc}$ ) ( $I_C = 100\text{ mAdc}$ , $V_{CE} = 1.0\text{ Vdc}$ )	$h_{FE}$	100 100	— —	—
Collector–Emitter Saturation Voltage ( $I_C = 100\text{ mAdc}$ , $I_B = 10\text{ mAdc}$ )	$V_{CE(sat)}$	—	0.25	Vdc
Base–Emitter On Voltage ( $I_C = 100\text{ mAdc}$ , $V_{CE} = 1.0\text{ Vdc}$ )	$V_{BE(on)}$	—	1.2	Vdc
<b>SMALL–SIGNAL CHARACTERISTICS</b>				
Current–Gain — Bandwidth Product <sup>(3)</sup> ( $I_C = 10\text{ mA}$ , $V_{CE} = 2.0\text{ V}$ , $f = 100\text{ MHz}$ )  ( $I_C = 100\text{ mAdc}$ , $V_{CE} = 1.0\text{ Vdc}$ , $f = 100\text{ MHz}$ )	$f_T$	100  50	—  —	MHz
		MPSA05 MPSA06		
		MPSA55 MPSA56		

3.  $f_T$  is defined as the frequency at which  $|h_{fe}|$  extrapolates to unity.

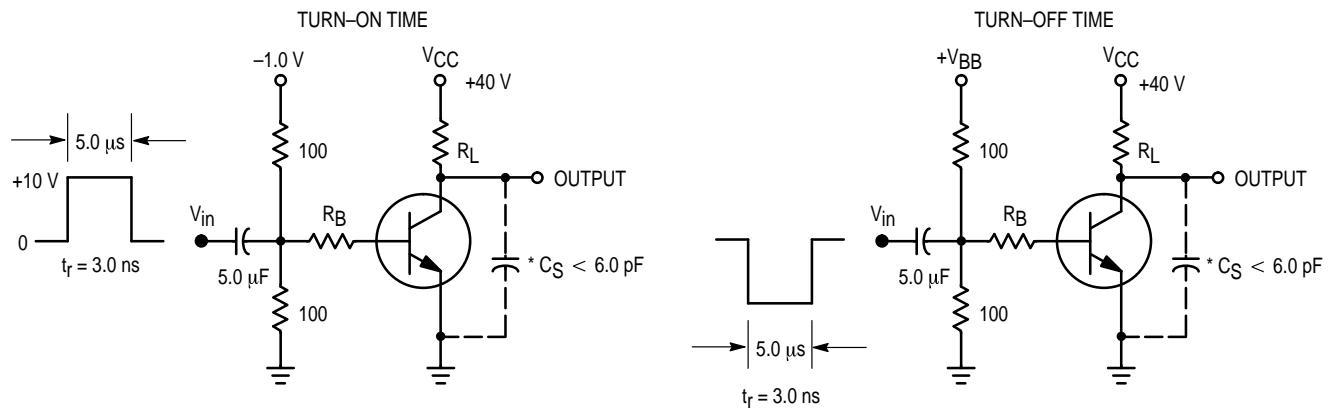

\* Total Shunt Capacitance of Test Jig and Connectors  
For PNP Test Circuits, Reverse All Voltage Polarities

**Figure 1. Switching Time Test Circuits**

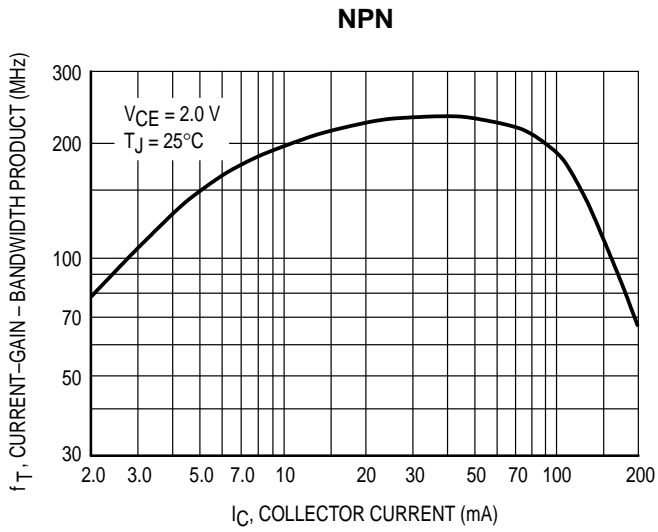

Figure 2. MPSA05/06 Current-Gain — Bandwidth Product

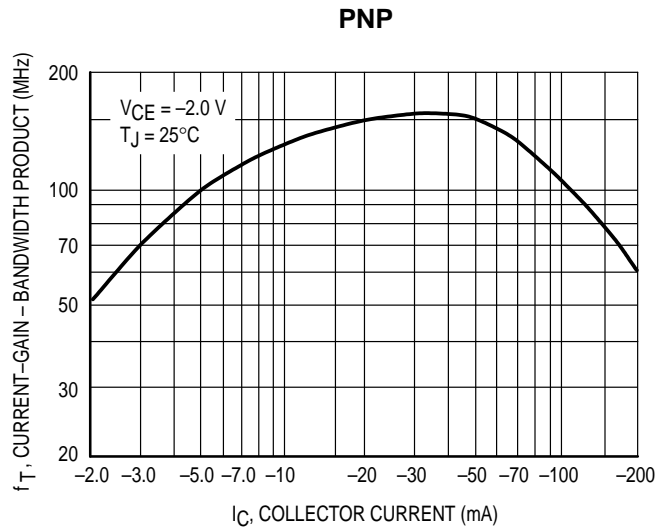

Figure 3. MPSA55/56 Current-Gain — Bandwidth Product

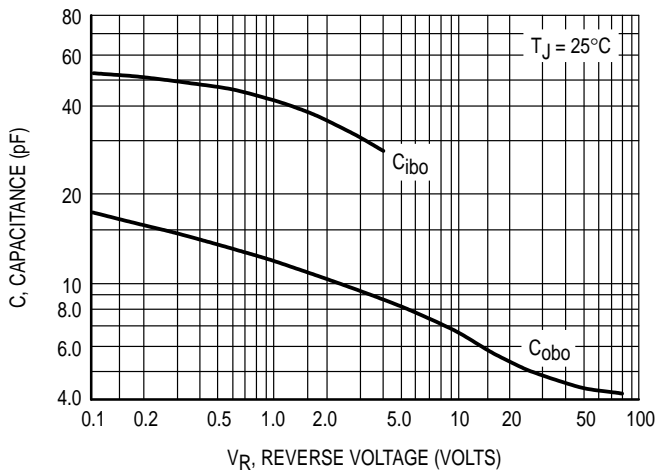

Figure 4. MPSA05/06 Capacitance

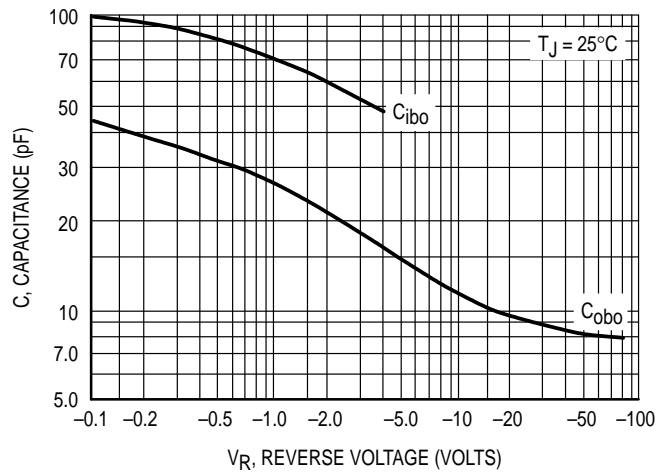

Figure 5. MPSA55/56 Capacitance

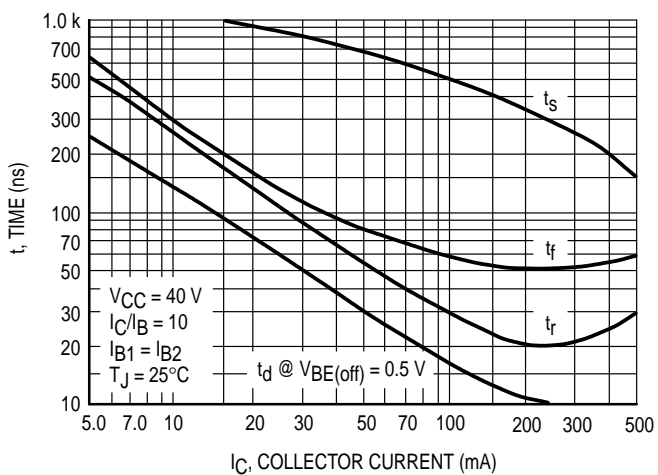

Figure 6. MPSA05/06 Switching Time

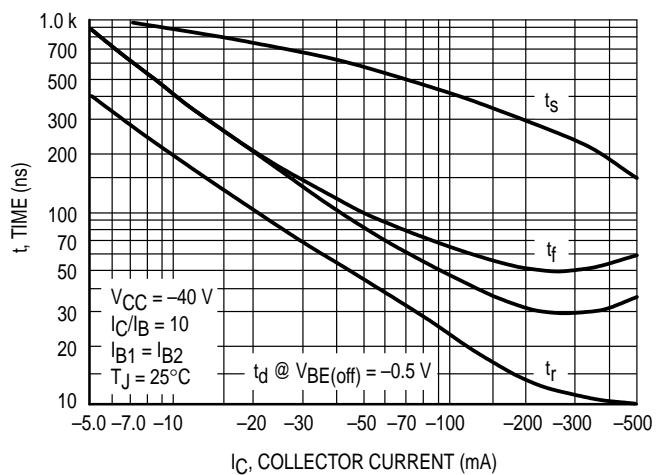

Figure 7. MPSA55/56 Switching Time

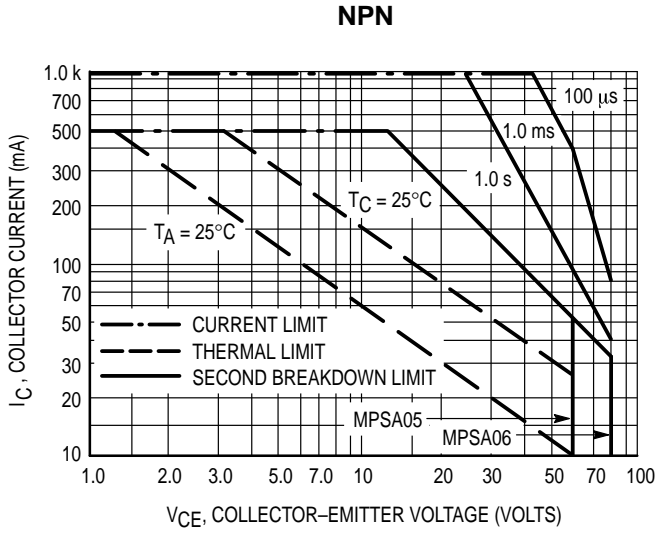

Figure 8. MPSA05/06 Active-Region Safe Operating Area

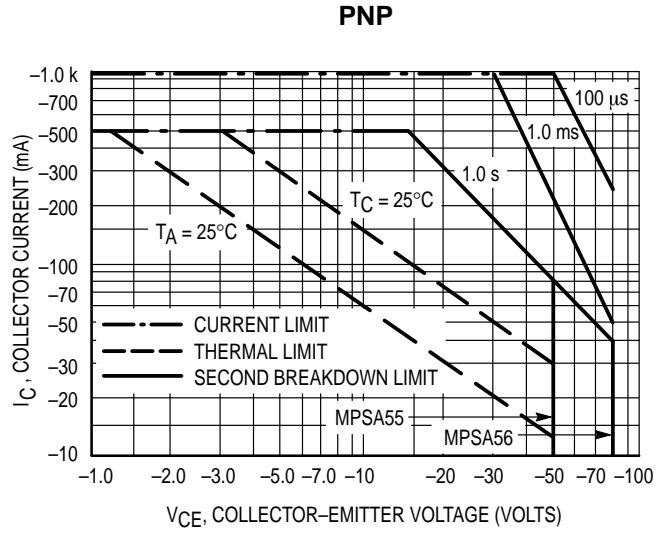

Figure 9. MPSA55/56 Active-Region Safe Operating Area

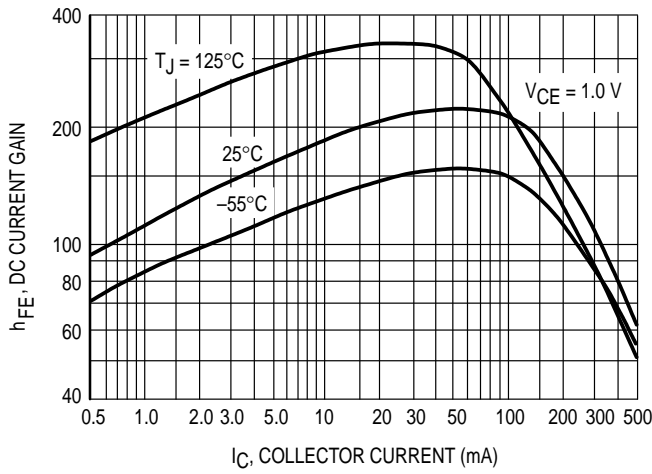

Figure 10. MPSA05/06 DC Current Gain

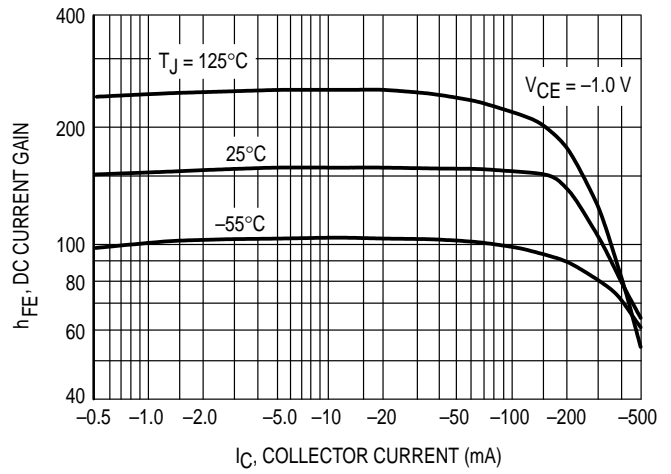

Figure 11. MPSA55/56 DC Current Gain

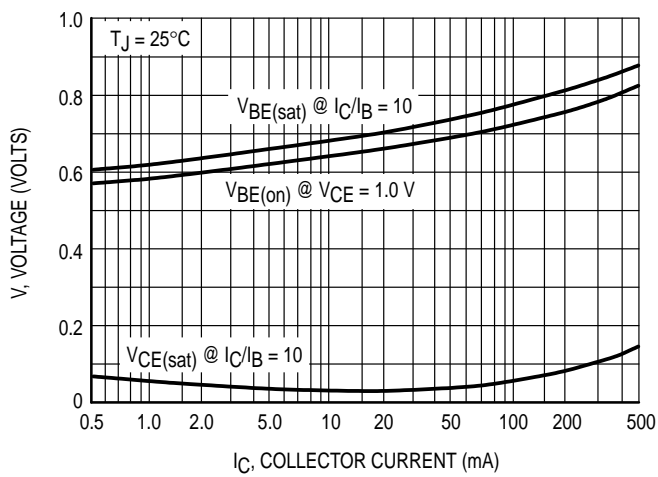

Figure 12. MPSA05/06 "ON" Voltages

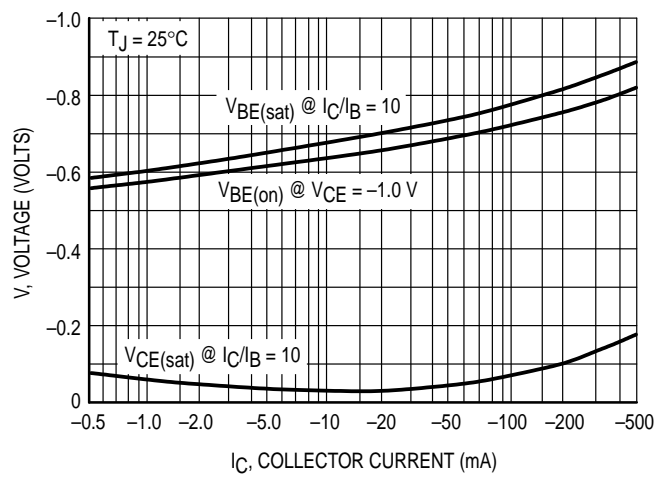

Figure 13. MPSA55/56 "ON" Voltages

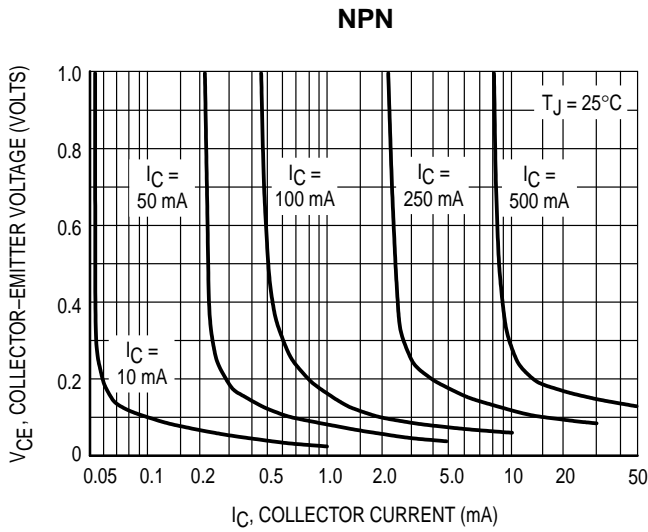

Figure 14. MPSA05/06 Collector Saturation Region

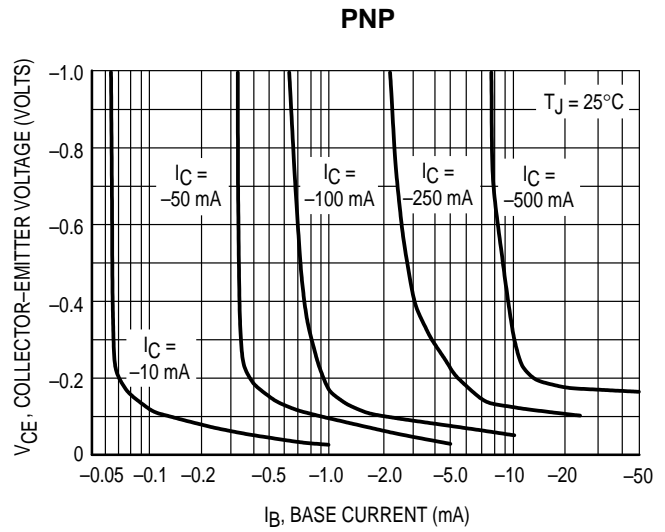

Figure 15. MPSA55/56 Collector Saturation Region

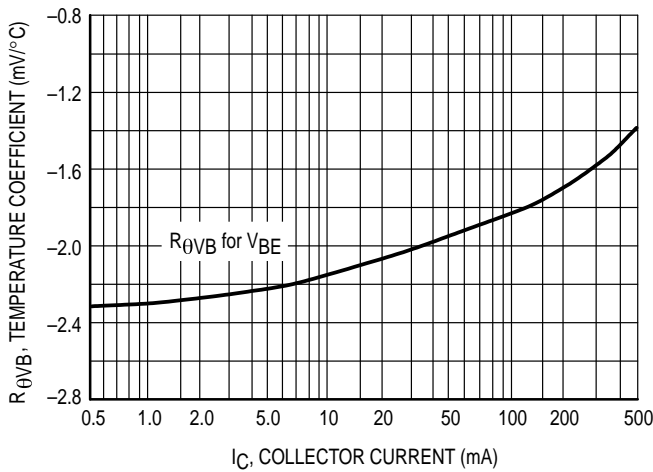

Figure 16. MPSA05/06 Base-Emitter Temperature Coefficient

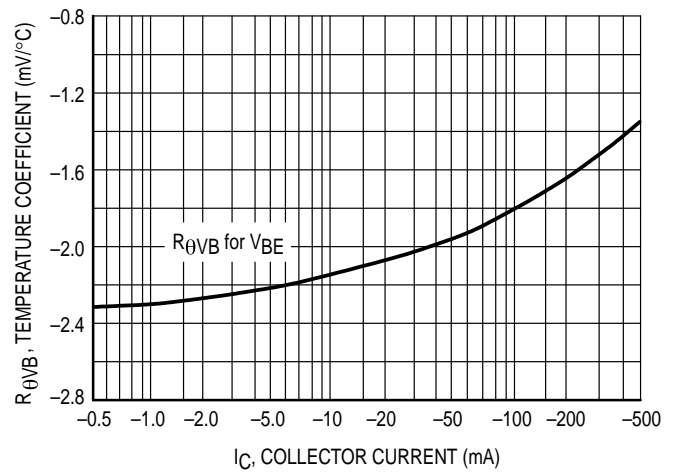

Figure 17. MPSA55/56 Base-Emitter Temperature Coefficient

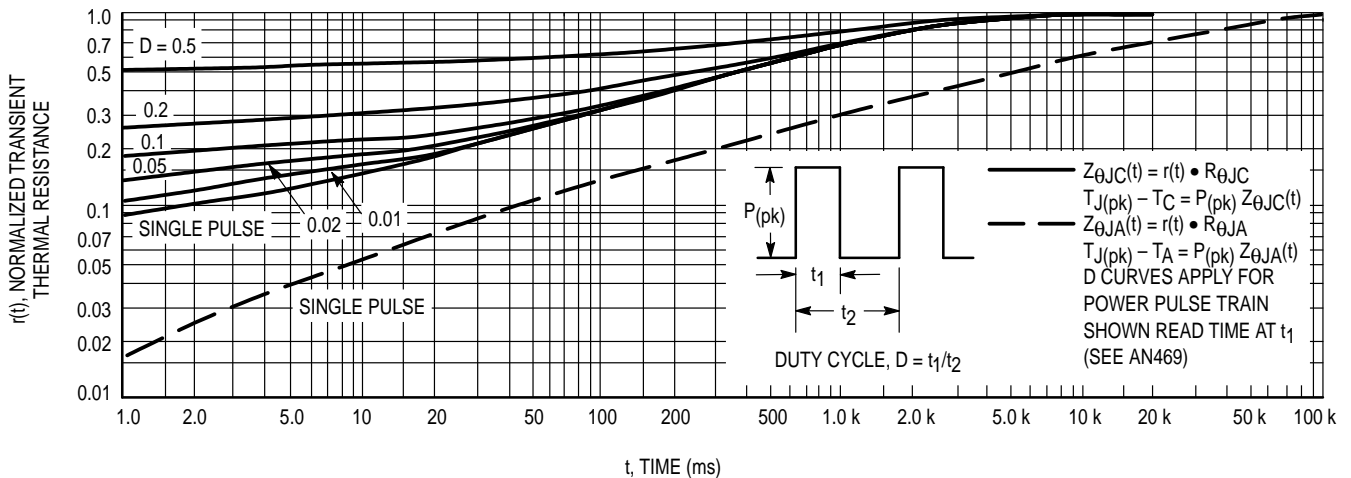
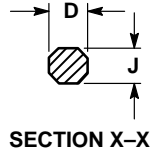

Figure 18. MPSA05, MPSA06, MPSA55 and MPSA56 Thermal Response

PACKAGE DIMENSIONS



CASE 029-04  
(TO-226AA)  
ISSUE AD

NOTES:

1. DIMENSIONING AND TOLERANCING PER ANSI Y14.5M, 1982.
2. CONTROLLING DIMENSION: INCH.
3. CONTOUR OF PACKAGE BEYOND DIMENSION R IS UNCONTROLLED.
4. DIMENSION F APPLIES BETWEEN P AND L. DIMENSION D AND J APPLY BETWEEN L AND K. MINIMUM LEAD DIMENSION IS UNCONTROLLED IN P AND BEYOND DIMENSION K MINIMUM.

DIM	INCHES		MILLIMETERS	
	MIN	MAX	MIN	MAX
A	0.175	0.205	4.45	5.20
B	0.170	0.210	4.32	5.33
C	0.125	0.165	3.18	4.19
D	0.016	0.022	0.41	0.55
F	0.016	0.019	0.41	0.48
G	0.045	0.055	1.15	1.39
H	0.095	0.105	2.42	2.66
J	0.015	0.020	0.39	0.50
K	0.500	—	12.70	—
L	0.250	—	6.35	—
N	0.080	0.105	2.04	2.66
P	—	0.100	—	2.54
R	0.115	—	2.93	—
V	0.135	—	3.43	—

STYLE 1:

1. EMITTER
2. BASE
3. COLLECTOR

Motorola reserves the right to make changes without further notice to any products herein. Motorola makes no warranty, representation or guarantee regarding the suitability of its products for any particular purpose, nor does Motorola assume any liability arising out of the application or use of any product or circuit, and specifically disclaims any and all liability, including without limitation consequential or incidental damages. "Typical" parameters which may be provided in Motorola data sheets and/or specifications can and do vary in different applications and actual performance may vary over time. All operating parameters, including "Typicals" must be validated for each customer application by customer's technical experts. Motorola does not convey any license under its patent rights nor the rights of others. Motorola products are not designed, intended, or authorized for use as components in systems intended for surgical implant into the body, or other applications intended to support or sustain life, or for any other application in which the failure of the Motorola product could create a situation where personal injury or death may occur. Should Buyer purchase or use Motorola products for any such unintended or unauthorized application, Buyer shall indemnify and hold Motorola and its officers, employees, subsidiaries, affiliates, and distributors harmless against all claims, costs, damages, and expenses, and reasonable attorney fees arising out of, directly or indirectly, any claim of personal injury or death associated with such unintended or unauthorized use, even if such claim alleges that Motorola was negligent regarding the design or manufacture of the part. Motorola and are registered trademarks of Motorola, Inc. Motorola, Inc. is an Equal Opportunity/Affirmative Action Employer.

How to reach us:

USA/EUROPE/Locations Not Listed: Motorola Literature Distribution; P.O. Box 20912; Phoenix, Arizona 85036. 1-800-441-2447 or 602-303-5454

JAPAN: Nippon Motorola Ltd.; Tatsumi-SPD-JLDC, 6F Seibu-Butsuryu-Center, 3-14-2 Tatsumi Koto-Ku, Tokyo 135, Japan. 03-81-3521-8315

MFAX: RMFA00@email.sps.mot.com – TOUCHTONE 602-244-6609  
INTERNET: <http://Design-NET.com>

ASIA/PACIFIC: Motorola Semiconductors H.K. Ltd.; 8B Tai Ping Industrial Park, 51 Ting Kok Road, Tai Po, N.T., Hong Kong. 852-26629298

