

## Low Voltage 1:18 Clock Distribution Chip

The MPC942 is a 1:18 low voltage clock distribution chip with 2.5V or 3.3V LVCMOS output capabilities. The device is offered in two versions; the MPC942C has an LVCMOS input clock while the MPC942P has a LVPECL input clock. The 18 outputs are 2.5V or 3.3V LVCMOS compatible and feature the drive strength to drive 50 $\Omega$  series or parallel terminated transmission lines. With output-to-output skews of 200ps, the MPC942 is ideal as a clock distribution chip for the most demanding of synchronous systems. The 2.5V outputs also make the device ideal for supplying clocks for a high performance Pentium II™ microprocessor based design.

- LVCMOS/LVTTL Clock Input
- 2.5V LVCMOS Outputs for Pentium II Microprocessor Support
- 150ps Maximum Targeted Output-to-Output Skew
- Maximum Output Frequency of 250MHz @ 3.3 V<sub>CC</sub>
- 32-Lead TQFP Packaging
- Single 3.3V or 2.5V Supply

With a low output impedance ( $\approx 12\Omega$ ), in both the HIGH and LOW logic states, the output buffers of the MPC942 are ideal for driving series terminated transmission lines. With an output impedance of 12 $\Omega$  the MPC942 can drive two series terminated transmission lines from each output. This capability gives the MPC942 an effective fanout of 1:36. The MPC942 provides enough copies of low skew clocks for most high performance synchronous systems.

The LVCMOS/LVTTL input of the MPC942C provides a more standard LVCMOS interface. The OE pins will place the outputs into a high impedance state. The OE pin has an internal pullup resistor.

The MPC942 is a single supply device. The V<sub>CC</sub> power pins require either 2.5V or 3.3V. The 32-lead TQFP package was chosen to optimize performance, board space and cost of the device. The 32-lead TQFP has a 7x7mm body size with a conservative 0.8mm pin spacing.

**MPC942C**

**LOW VOLTAGE  
1:18 CLOCK  
DISTRIBUTION CHIP**



**FA SUFFIX**  
32-LEAD TQFP PACKAGE  
CASE 873A-02

Pentium II is a trademark of Intel Corporation.



# MPC942C

## LOGIC DIAGRAM

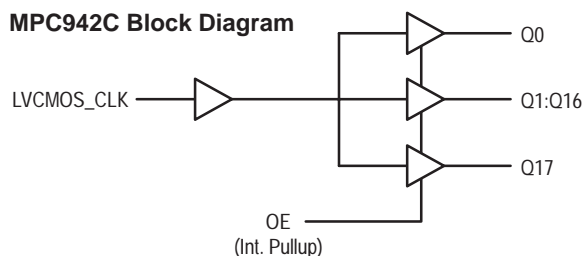

## FUNCTION TABLE

OE	Output
0	HIGH IMPEDANCE
1	OUTPUTS ENABLED

## Pinout: 32-Lead (Top View)

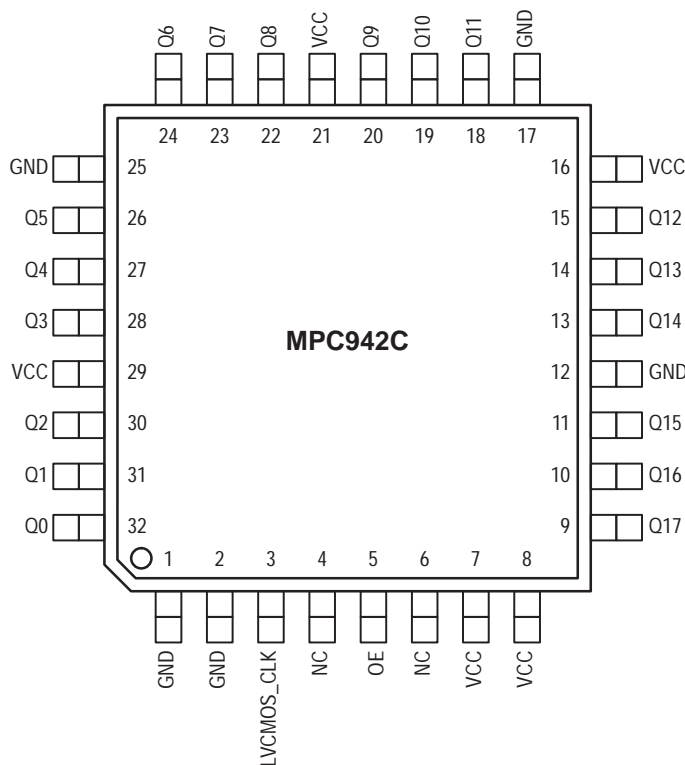

## ABSOLUTE MAXIMUM RATING

Symbol	Parameter	Min	Max	Unit
V <sub>CC</sub>	Supply Voltage	-0.3	3.6	V
V <sub>I</sub>	Input Voltage	-0.3	V <sub>CC</sub> + 0.3	V
I <sub>IN</sub>	Input Current		±20	mA
T <sub>Stor</sub>	Storage Temperature Range	-40	125	°C

Motorola reserves the right to make changes without further notice to any products herein. Motorola makes no warranty, representation or guarantee regarding the suitability of its products for any particular purpose, nor does Motorola assume any liability arising out of the application or use of any product or circuit, and specifically disclaims any and all liability, including without limitation consequential or incidental damages. "Typical" parameters which may be provided in Motorola data sheets and/or specifications can and do vary in different applications and actual performance may vary over time. All operating parameters, including "Typicals" must be validated for each customer application by customer's technical experts. Motorola does not convey any license under its patent rights nor the rights of others. Motorola products are not designed, intended, or authorized for use as components in systems intended for surgical implant into the body, or other applications intended to support or sustain life, or for any other application in which the failure of the Motorola product could create a situation where personal injury or death may occur. Should Buyer purchase or use Motorola products for any such unintended or unauthorized application, Buyer shall indemnify and hold Motorola and its officers, employees, subsidiaries, affiliates, and distributors harmless against all claims, costs, damages, and expenses, and reasonable attorney fees arising out of, directly or indirectly, any claim of personal injury or death associated with such unintended or unauthorized use, even if such claim alleges that Motorola was negligent regarding the design or manufacture of the part. Motorola and are registered trademarks of Motorola, Inc. Motorola, Inc. is an Equal Opportunity/Affirmative Action Employer.

**DC CHARACTERISTICS** ( $T_A = 0^\circ$  to  $70^\circ\text{C}$ ,  $V_{CCI} = 2.5\text{V} \pm 5\%$ ,  $V_{CCO} = 2.5\text{V} \pm 5\%$ )

Symbol	Characteristic	Min	Typ	Max	Unit	Condition
$V_{IH}$	Input HIGH Voltage	2.0		$V_{CCI}$	V	
$V_{IL}$	Input LOW Voltage			0.8	V	
$V_{OH}$	Output HIGH Voltage	2.0			V	$I_{OH} = -16\text{ mA}$
$V_{OL}$	Output LOW Voltage			0.5	V	$I_{OL} = 16\text{ mA}$
$I_{IN}$	Input Current			$\pm 200$	$\mu\text{A}$	
$C_{IN}$	Input Capacitance		4.0		pF	
CPD	Power Dissipation Capacitance		14		pF	Per Output
$Z_{OUT}$	Output Impedance		12		$\Omega$	
$I_{CC}$	Maximum Quiescent Supply Current		0.5		mA	

**AC CHARACTERISTICS** ( $T_A = 0^\circ$  to  $70^\circ\text{C}$ ,  $V_{CCI} = 2.5\text{V} \pm 5\%$ ,  $V_{CCO} = 2.5\text{V} \pm 5\%$ )

Symbol	Characteristic	Min	Typ	Max	Unit	Condition
$F_{max}$	Maximum Frequency			200	MHz	
$t_{PLH}$	Propagation Delay	1.5		2.8	ns	
$t_{sk(o)}$	Output-to-Output Skew			200	ps	
$t_{sk(pr)}$	Part-to-Part Skew			1.3	ns	Notes 1, 2
$t_{sk(pr)}$	Part-to-Part Skew			600	ps	Notes 1, 3
$d_t$	Duty Cycle	45		55	%	
$t_r, t_f$	Output Rise/Fall Time	0.2		1.0	ns	

**DC CHARACTERISTICS** ( $T_A = 0^\circ$  to  $70^\circ\text{C}$ ,  $V_{CCI} = 3.3\text{V} \pm 5\%$ ,  $V_{CCO} = 3.3\text{V} \pm 5\%$ )

Symbol	Characteristic	Min	Typ	Max	Unit	Condition
$V_{IH}$	Input HIGH Voltage	2.4		$V_{CCI}$	V	
$V_{IL}$	Input LOW Voltage			0.8	V	
$V_{OH}$	Output HIGH Voltage	2.4			V	$I_{OH} = -20\text{ mA}$
$V_{OL}$	Output LOW Voltage			0.5	V	$I_{OL} = 20\text{ mA}$
$I_{IN}$	Input Current			$\pm 200$	$\mu\text{A}$	
$C_{IN}$	Input Capacitance		4.0		pF	
CPD	Power Dissipation Capacitance		14		pF	Per Output
$Z_{OUT}$	Output Impedance		12		$\Omega$	
$I_{CC}$	Maximum Quiescent Supply Current		0.5		mA	

**AC CHARACTERISTICS** ( $T_A = 0^\circ$  to  $70^\circ\text{C}$ ,  $V_{CCI} = 3.3\text{V} \pm 5\%$ ,  $V_{CCO} = 3.3\text{V} \pm 5\%$ )

Symbol	Characteristic	Min	Typ	Max	Unit	Condition
$F_{max}$	Maximum Frequency			250	MHz	
$t_{PLH}$	Propagation Delay	1.3		2.3	ns	Note 1
$t_{sk(o)}$	Output-to-Output Skew			200	ps	
$t_{sk(pr)}$	Part-to-Part Skew			1.0	ns	Notes 1, 2
$t_{sk(pr)}$	Part-to-Part Skew			500	ps	Notes 1, 3
$d_t$	Duty Cycle	45		55	%	
$t_r, t_f$	Output Rise/Fall Time	0.2		1.0	ns	

1. Tested using standard input levels, production tested @ 133 MHz.
2. Across temperature and voltage ranges, includes output skew.
3. For a specific temperature and voltage, includes output skew.

OUTLINE DIMENSIONS

FA SUFFIX  
TQFP PACKAGE  
CASE 873A-02  
ISSUE A

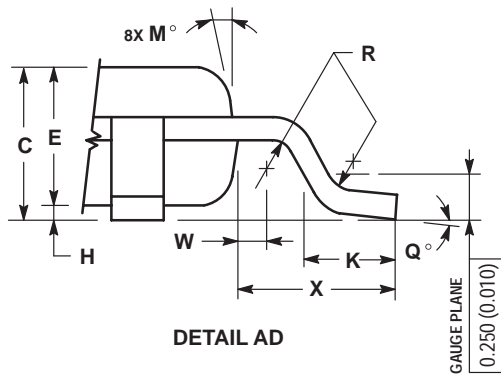
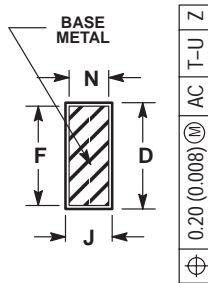
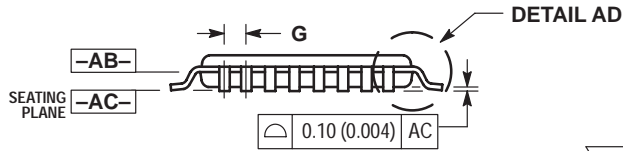
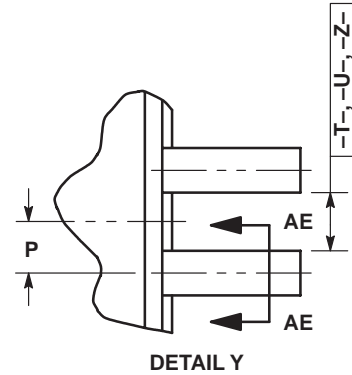
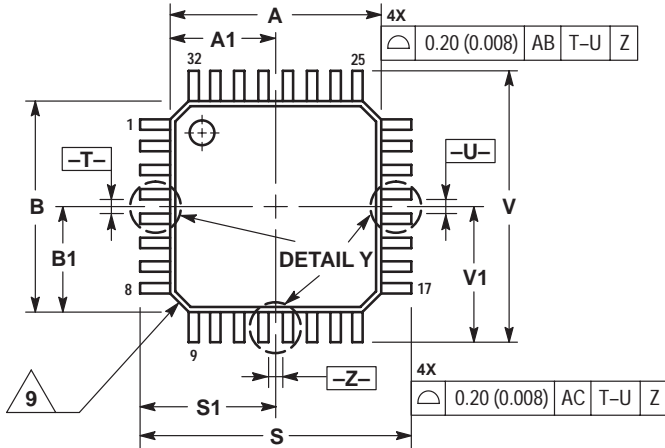

- NOTES:
- DIMENSIONING AND TOLERANCING PER ANSI Y14.5M, 1982.
  - CONTROLLING DIMENSION: MILLIMETER.
  - DATUM PLANE -AB- IS LOCATED AT BOTTOM OF LEAD AND IS COINCIDENT WITH THE LEAD WHERE THE LEAD EXITS THE PLASTIC BODY AT THE BOTTOM OF THE PARTING LINE.
  - DATUMS -T-, -U-, AND -Z- TO BE DETERMINED AT DATUM PLANE -AB-.
  - DIMENSIONS S AND V TO BE DETERMINED AT SEATING PLANE -AC-.
  - DIMENSIONS A AND B DO NOT INCLUDE MOLD PROTRUSION. ALLOWABLE PROTRUSION IS 0.250 (0.010) PER SIDE. DIMENSIONS A AND B DO INCLUDE MOLD MISMATCH AND ARE DETERMINED AT DATUM PLANE -AB-.
  - DIMENSION D DOES NOT INCLUDE DAMBAR PROTRUSION. DAMBAR PROTRUSION SHALL NOT CAUSE THE D DIMENSION TO EXCEED 0.520 (0.020).
  - MINIMUM SOLDER PLATE THICKNESS SHALL BE 0.0076 (0.0003).
  - EXACT SHAPE OF EACH CORNER MAY VARY FROM DEPICTION.

DIM	MILLIMETERS		INCHES	
	MIN	MAX	MIN	MAX
A	7.000 BSC	0.276 BSC		
A1	3.500 BSC	0.138 BSC		
B	7.000 BSC	0.276 BSC		
B1	3.500 BSC	0.138 BSC		
C	1.400	1.600	0.055	0.063
D	0.300	0.450	0.012	0.018
E	1.350	1.450	0.053	0.057
F	0.300	0.400	0.012	0.016
G	0.800 BSC	0.031 BSC		
H	0.050	0.150	0.002	0.006
J	0.090	0.200	0.004	0.008
K	0.500	0.700	0.020	0.028
M	12° REF	12° REF		
N	0.090	0.160	0.004	0.006
P	0.400 BSC	0.016 BSC		
Q	1°	5°	1°	5°
R	0.150	0.250	0.006	0.010
S	9.000 BSC	0.354 BSC		
S1	4.500 BSC	0.177 BSC		
V	9.000 BSC	0.354 BSC		
V1	4.500 BSC	0.177 BSC		
W	0.200 REF	0.008 REF		
X	1.000 REF	0.039 REF		

Mfax is a trademark of Motorola, Inc.

How to reach us:

USA/EUROPE/Locations Not Listed: Motorola Literature Distribution; P.O. Box 5405, Denver, Colorado 80217. 1-303-675-2140 or 1-800-441-2447

JAPAN: Motorola Japan Ltd.; SPD, Strategic Planning Office, 141, 4-32-1 Nishi-Gotanda, Shinagawa-ku, Tokyo, Japan. 81-3-5487-8488

Customer Focus Center: 1-800-521-6274

Mfax™: RMFAX0@email.sps.mot.com – TOUCHTONE 1-602-244-6609  
Motorola Fax Back System – US & Canada ONLY 1-800-774-1848  
– http://sps.motorola.com/mfax/

ASIA/PACIFIC: Motorola Semiconductors H.K. Ltd.; Silicon Harbour Centre, 2, Dai King Street, Tai Po Industrial Estate, Tai Po, N.T., Hong Kong. 852-26668334

HOME PAGE: http://motorola.com/sps/

