

#### 200 Volt, 1.5Ω HEXFET

HEXFET technology is the key to International Rectifier's advanced line of power MOSFET transistors. The efficient geometry achieves very low on-state resistance combined with high transconductance.

HEXFET transistors also feature all of the well-established advantages of MOSFETs, such as voltage control, very fast switching, ease of paralleling and electrical parameter temperature stability. They are well-suited for applications such as switching power supplies, motor controls, inverters, choppers, audio amplifiers, and high energy pulse circuits, and virtually any application where high reliability is required.

#### Product Summary

Part Number	BV <sub>DSS</sub>	R <sub>DS(on)</sub>	I <sub>D</sub>
JANTX2N6784	200V	1.5Ω	2.25A
JANTXV2N6784			

#### Features:

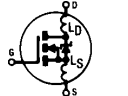
- Avalanche Energy Rating
- Dynamic dv/dt Rating
- Simple Drive Requirements
- Ease of Paralleling
- Hermetically Sealed

#### Absolute Maximum Ratings


	Parameter	JANTX2N6784, JANTXV2N6784	Units
I <sub>D</sub> @ V <sub>GS</sub> = 10V, T <sub>C</sub> = 25°C	Continuous Drain Current	2.25	A
I <sub>D</sub> @ V <sub>GS</sub> = 10V, T <sub>C</sub> = 100°C	Continuous Drain Current	1.50	
I <sub>DM</sub>	Pulsed Drain Current ①	9.0	
P <sub>D</sub> @ T <sub>C</sub> = 25°C	Max. Power Dissipation	15	W
	Linear Derating Factor	0.12	W/K ⑤
V <sub>GS</sub>	Gate-to-Source Voltage	±20	V
dv/dt	Peak Diode Recovery dv/dt ③	5.0	V/ns
T <sub>J</sub>	Operating Junction	-55 to 150	°C
T <sub>STG</sub>	Storage Temperature Range		
	Lead Temperature	300 (0.063 in. (1.6mm) from case for 10.5 seconds)	
	Weight	0.98 (typical)	

# JANTX2N6784, JANTXV2N6784 Device

## Electrical Characteristics @ Tj = 25°C (Unless Otherwise Specified)

	Parameter	Min.	Typ.	Max.	Units	Test Conditions
$BV_{DSS}$	Drain-to-Source Breakdown Voltage	200	—	—	V	$V_{GS} = 0V, I_D = 1.0 \text{ mA}$
$\Delta BV_{DSS}/\Delta T_J$	Temperature Coefficient of Breakdown Voltage	—	0.25	—	V/°C	Reference to 25°C, $I_D = 1.0 \text{ mA}$
RDS(on)	Static Drain-to-Source On-State Resistance	—	—	1.5	$\Omega$	$V_{GS} = 10V, I_D = 1.5A$ ④
		—	—	1.725		$V_{GS} = 10V, I_D = 2.25A$
$V_{GS(th)}$	Gate Threshold Voltage	2.0	—	4.0	V	$V_{DS} = V_{GS}, I_D = 250\mu A$
$g_{fs}$	Forward Transconductance	0.9	—	—	S (r)	$V_{DS} > 15V, I_{DS} = 1.5A$ ④
IDSS	Zero Gate Voltage Drain Current	—	—	25	$\mu A$	$V_{DS} = 0.8 \times \text{Max Rating}, V_{GS} = 0V$
		—	—	250		$V_{DS} = 0.8 \times \text{Max Rating}, V_{GS} = 0V, T_J = 125^\circ C$
IGSS	Gate-to-Source Leakage Forward	—	—	100	nA	$V_{GS} = 20V$
IGSS	Gate-to-Source Leakage Reverse	—	—	-100	nA	$V_{GS} = -20V$
$Q_g$	Total Gate Charge	4.3	—	6.2	nC	$V_{GS} = 10V, I_D = 2.25A$
$Q_{gs}$	Gate-to-Source Charge	0.7	—	1.2		$V_{DS} = \text{Max. Rating} \times 0.5$
$Q_{gd}$	Gate-to-Drain ("Miller") Charge	0.5	—	5.0		see figures 6 and 13
$t_{d(on)}$	Turn-On Delay Time	—	—	15	ns	$V_{DD} = 100V, I_D = 2.25A, R_G = 7.5\Omega, V_{GS} = 10V$
$t_r$	Rise Time	—	—	20		
$t_{d(off)}$	Turn-Off Delay Time	—	—	30		
$t_f$	Fall Time	—	—	20		
LD	Internal Drain Inductance	—	5.0	—	nH	<p>Measured from the drain lead, 6mm (0.25 in.) from package to center of die.</p> <p>Measured from the source lead, 6mm (0.25 in.) from package to source bonding pad.</p> 
LS	Internal Source Inductance	—	15	—		
$C_{iss}$	Input Capacitance	—	140	—	pF	$V_{GS} = 0V, V_{DS} = 25V$ $f = 1.0 \text{ MHz}$ see figure 5
$C_{oss}$	Output Capacitance	—	55	—		
$C_{rss}$	Reverse Transfer Capacitance	—	8.6	—		

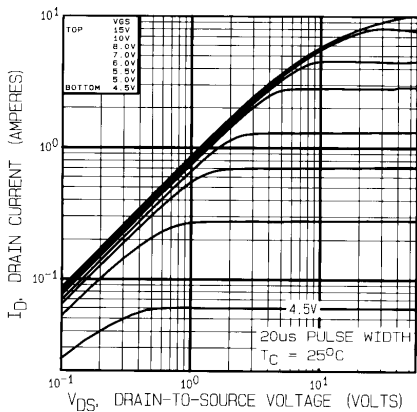
## Source-Drain Diode Ratings and Characteristics

	Parameter	Min.	Typ.	Max.	Units	Test Conditions
$I_S$	Continuous Source Current (Body Diode)	—	—	2.25	A	Modified MOSFET symbol showing the integral reverse p-n junction rectifier. 
$I_{SM}$	Pulse Source Current (Body Diode) ①	—	—	9.0		
$V_{SD}$	Diode Forward Voltage	—	—	1.5	V	$T_J = 25^\circ C, I_S = 2.25A, V_{GS} = 0V$ ④
$t_{rr}$	Reverse Recovery Time	—	—	350	ns	$T_J = 25^\circ C, I_F = 2.25A, di/dt \leq 100A/\mu s$ $V_{DD} \leq 50V$ ④
$Q_{RR}$	Reverse Recovery Charge	—	—	3.0	$\mu C$	
$t_{on}$	Forward Turn-On Time	Intrinsic turn-on time is negligible. Turn-on speed is substantially controlled by $L_S + L_D$ .				

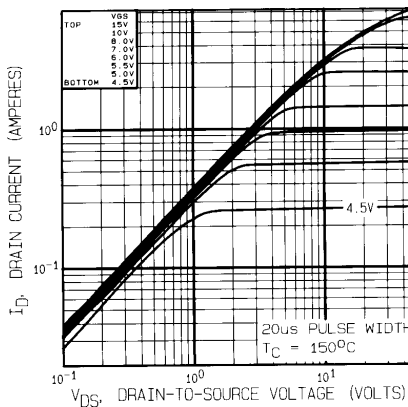
## Thermal Resistance

	Parameter	Min.	Typ.	Max.	Units	Test Conditions
$R_{thJC}$	Junction-to-Case	—	—	8.3	K/W	Typical socket mount
$R_{thJA}$	Junction-to-Ambient	—	—	175		

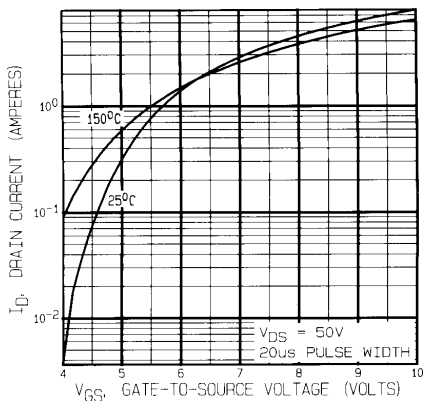
# JANTX2N6784, JANTXV2N6784 Device



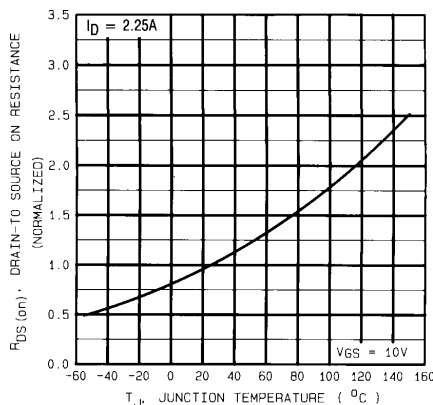
**Fig. 1 — Typical Output Characteristics**  
 $T_C = 25^\circ\text{C}$



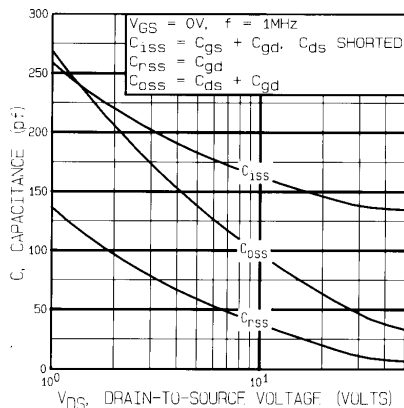
**Fig. 2 — Typical Output Characteristics**  
 $T_C = 150^\circ\text{C}$



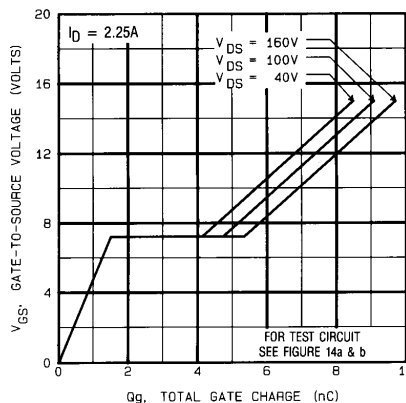
**Fig. 3 — Typical Transfer Characteristics**



**Fig. 4 — Normalized On-Resistance Vs. Temperature**

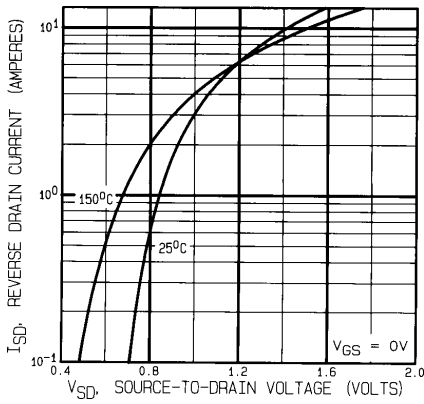


**Fig. 5 — Typical Capacitance Vs. Drain-to-Source Voltage**

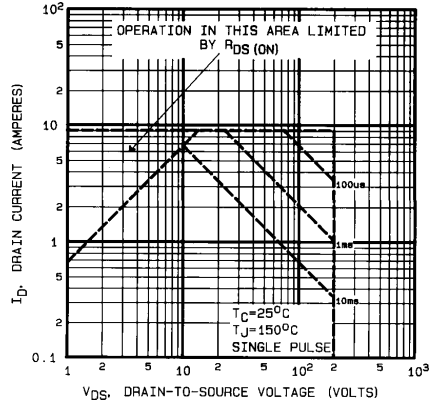


**Fig. 6 — Typical Gate Charge Vs. Gate-to-Source Voltage**

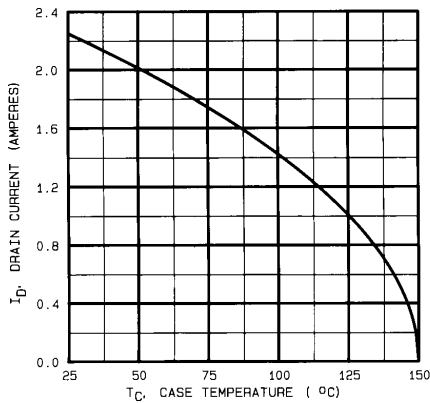
# JANTX2N6784, JANTXV2N6784 Device



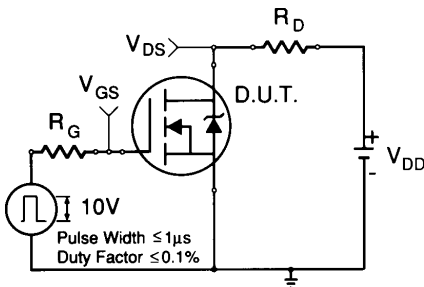
**Fig. 7 — Typical Source-to-Drain Diode Forward Voltage**



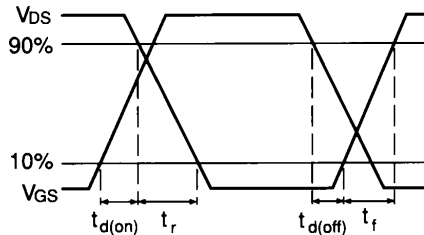
**Fig. 8 — Maximum Safe Operating Area**



**Fig. 9 — Maximum Drain Current Vs. Case Temperature**



**Fig. 10a — Switching Time Test Circuit**



**Fig. 10b — Switching Time Waveforms**

# JANTX2N6784, JANTXV2N6784 Device

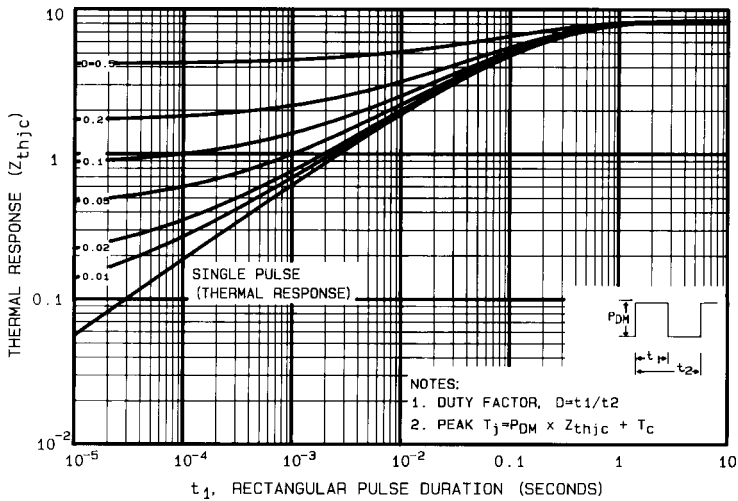


Fig. 11 — Maximum Effective Transient Thermal Impedance, Junction-to-Case Vs. Pulse Duration

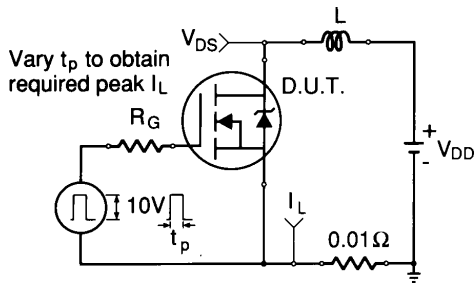


Fig. 12a — Unclamped Inductive Test Circuit

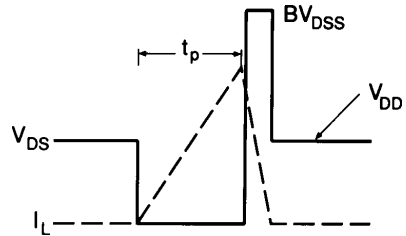


Fig. 12b — Unclamped Inductive Waveforms

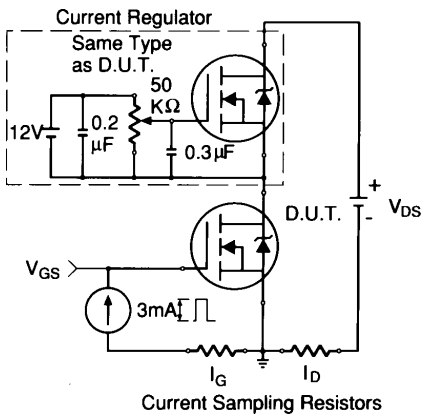


Fig. 13a — Gate Charge Test Circuit

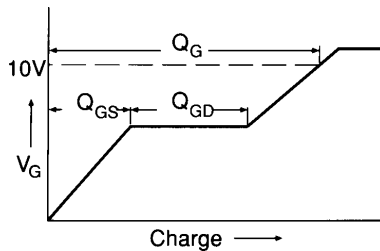
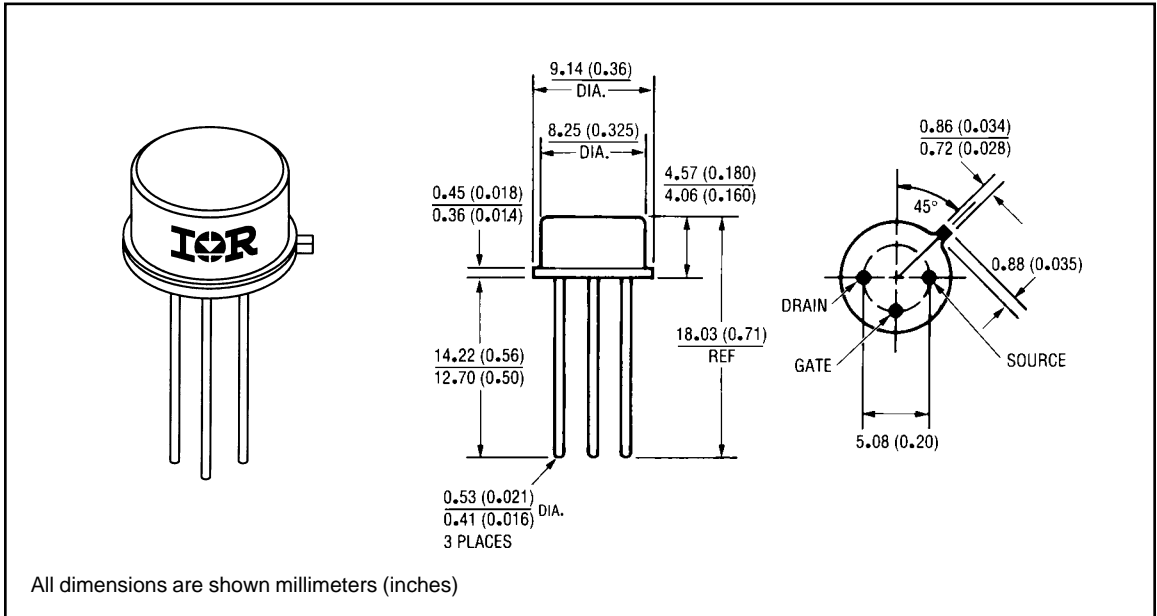


Fig. 13b — Basic Gate Charge Waveform

## JANTX2N6784, JANTXV2N6784 Device

- ① Repetitive Rating; Pulse width limited by maximum junction temperature. (see figure 11)
- ② @  $V_{DD} = 50V$ , Starting  $T_J = 25^\circ C$ ,  
 $E_{AS} = [0.5 * L * (I_L^2) * [BV_{DSS}/(BV_{DSS}-V_{DD})]]$   
 Peak  $I_L = 2.25A$ ,  $V_{GS} = 10V$ ,  $25 \leq R_G \leq 200\Omega$
- ③  $ISD \leq 2.25A$ ,  $di/dt \leq 70A/\mu s$ ,  
 $V_{DD} \leq BV_{DSS}$ ,  $T_J \leq 150^\circ C$
- ④ Pulse width  $\leq 300 \mu s$ ; Duty Cycle  $\leq 2\%$
- ⑤  $K/W = ^\circ C/W$   
 $W/K = W/^\circ C$

### Case Outline and Dimensions — TO-205AF (Modified TO-39)



International  
**IR** Rectifier

**WORLD HEADQUARTERS:** 233 Kansas St., El Segundo, California 90245, Tel: (310) 322 3331

**EUROPEAN HEADQUARTERS:** Hurst Green, Oxted, Surrey RH8 9BB, UK Tel: ++ 44 1883 732020

**IR CANADA:** 7321 Victoria Park Ave., Suite 201, Markham, Ontario L3R 2Z8, Tel: (905) 475 1897

**IR GERMANY:** Saalburgstrasse 157, 61350 Bad Homburg Tel: ++ 49 6172 96590

**IR ITALY:** Via Liguria 49, 10071 Borgaro, Torino Tel: ++ 39 11 451 0111

**IR FAR EAST:** K&H Bldg., 2F, 3-30-4 Nishi-Ikeburo 3-Chome, Toshima-Ki, Tokyo Japan 171 Tel: 81 3 3983 0086

**IR SOUTHEAST ASIA:** 315 Outram Road, #10-02 Tan Boon Liat Building, Singapore 0316 Tel: 65 221 8371

<http://www.irf.com/> Data and specifications subject to change without notice. 10/96