

CM20MD-12H

MEDIUM POWER SWITCHING USE
INSULATED TYPE

CM20MD-12H

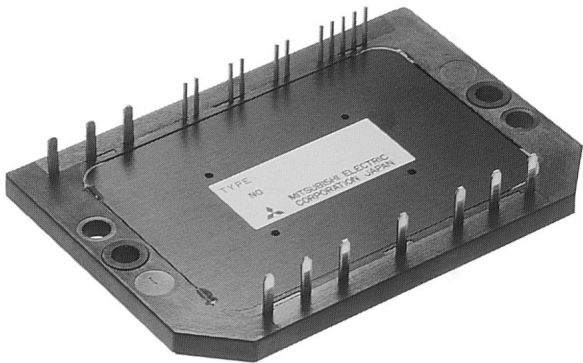

- IC 20A
- VCES 600V
- Insulated Type
- CIB Module
3φ Inverter+3φ Converter+Brake
- UL Recognized

Yellow Card No. E80276 (N)
File No. E80271

APPLICATION

AC & DC motor controls, General purpose inverters, Servo controls, NC, Robotics

OUTLINE DRAWING & CIRCUIT DIAGRAM

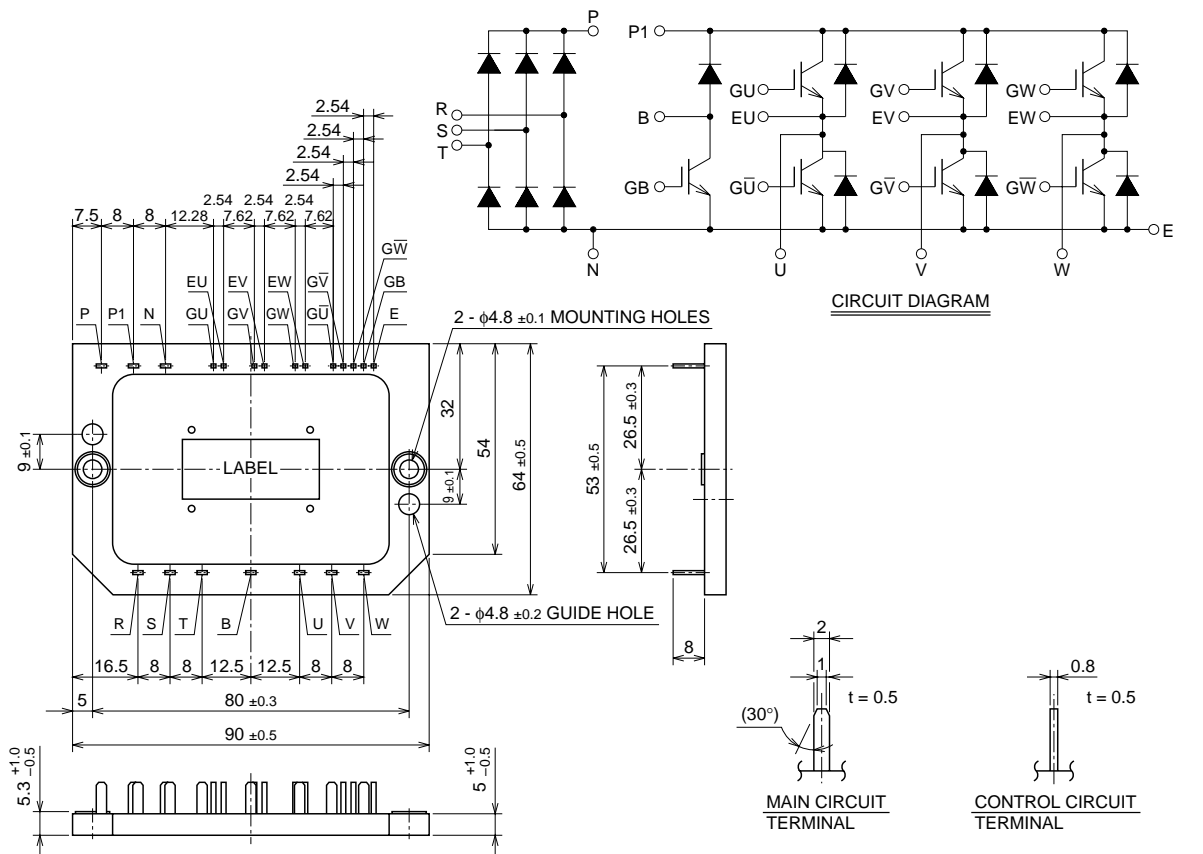

Note. Not use the guiding holes to mount on the cooling fin.

CM20MD-12H

MEDIUM POWER SWITCHING USE
INSULATED TYPE**MAXIMUM RATINGS** ($T_j = 25^\circ\text{C}$)
INVERTER PART

Symbol	Parameter	Condition	Rating	Unit
V _{CES}	Collector-emitter voltage	G – E Short	600	V
V _{GES}	Gate-emitter voltage	C – E Short	±20	V
I _C	Collector Current	T _C = 25°C	20	A
I _{CM}		PULSE (Note. 2)	40	A
I _E (Note. 1)	Emitter Current	T _C = 25°C	20	A
I _{EM} (Note. 1)		PULSE (Note. 2)	40	A
P _C (Note. 3)	Maximum collector dissipation	T _f = 25°C	57	W

BRAKE PART

Symbol	Parameter	Condition	Rating	Unit
V _{CES}	Collector-emitter voltage	G – E Short	600	V
V _{GES}	Gate-emitter voltage	C – E Short	±20	V
I _C	Collector Current	T _C = 25°C	20	A
I _{CM}		PULSE (Note. 2)	40	A
P _C (Note. 3)	Maximum Collector dissipation	T _f = 25°C	57	W
V _{RRM}	Repetitive peak reverse voltage	Clamp diode part	600	V
I _{FM} (Note. 3)	Forward current	Clamp diode part	20	A

CONVERTER PART

Symbol	Parameter	Condition	Rating	Unit
V _{RRM}	Repetitive peak reverse voltage		800	V
E _a	Recommended AC input voltage		220	V
I _O	DC output current	3 ϕ rectifying circuit	20	A
I _{FSM}	Surge (non-repetitive) forward current	1 cycle at 60Hz, peak value Non-repetitive	200	A
I ² t	I ² t for fusing	Value for one cycle of surge current	165	A ² s

COMMON RATING

Symbol	Parameter	Condition	Rating	Unit
T _j	Junction temperature		-40 ~ +150	°C
T _{stg}	Storage temperature		-40 ~ +125	°C
V _{iso}	Isolation voltage	AC 1 min.	2500	V
—	Mounting torque	Mounting M4 screw	1.47 ~ 1.96	N · m
—	Weight	Typical value	60	g

CM20MD-12H

MEDIUM POWER SWITCHING USE
INSULATED TYPEELECTRICAL CHARACTERISTICS (T_j = 25°C)
INVERTER PART

Symbol	Parameter	Test conditions	Limits			Unit
			Min.	Typ.	Max.	
ICES	Collector cutoff current	VCE = VCES, VGE = 0V	—	—	1	mA
VGE(th)	Gate-emitter threshold voltage	IC = 2mA, VCE = 10V	4.5	6	7.5	V
IGES	Gate-emitter cutoff current	VGE = VGES, VCE = 0V	—	—	0.5	μA
VCE(sat)	Collector-emitter saturation voltage	T _j = 25°C	—	2.1	2.8	V
		T _j = 150°C	—	2.15	—	
Cies	Input capacitance	VCE = 10V VGE = 0V	—	—	2.0	nF
Coēs	Output capacitance		—	—	1.5	nF
Cres	Reverse transfer capacitance		—	—	0.4	nF
QG	Total gate charge	VCC = 300V, IC = 20A, VGE = 15V	—	60	—	nC
td (on)	Turn-on delay time	VCC = 300V, IC = 20A	—	—	120	ns
tr	Turn-on rise time	VGE1 = VGE2 = 15V	—	—	300	ns
td (off)	Turn-off delay time	RG = 31Ω	—	—	200	ns
tf	Turn-off fall time	Resistive load	—	—	300	ns
VEC (Note. 1)	Emitter-collector voltage	IE = 20A, VGE = 0V	—	—	2.8	V
trr (Note. 1)	Reverse recovery time	IE = 20A, VGE = 0V	—	—	110	ns
Qrr (Note. 1)	Reverse recovery charge	die / dt = -40A / μs	—	0.05	—	μC
R _{th(j-f)Q} (Note. 5)	Thermal resistance	IGBT part, Per 1/6 module	—	—	2.2	°C/W
R _{th(j-f)R} (Note. 5)		FWDi part, Per 1/6 module	—	—	3.1	°C/W

BRAKE PART

Symbol	Parameter	Condition	Limits			Unit
			Min.	Typ.	Max.	
ICES	Collector cutoff current	VCE = VCES, VGE = 0V	—	—	1	mA
VGE(th)	Gate-emitter threshold voltage	IC = 2mA, VCE = 10V	4.5	6	7.5	V
IGES	Gate-emitter cutoff current	VGE = VGES, VCE = 0V	—	—	0.5	μA
VCE(sat)	Collector-to-emitter saturation voltage	T _j = 25°C	—	2.1	2.8	V
		T _j = 150°C	—	2.15	—	
Cies	Input capacitance	VCE = 10V VGE = 0V	—	—	2.0	nF
Coēs	Output capacitance		—	—	1.5	nF
Cres	Reverse transfer capacitance		—	—	0.4	nF
QG	Total gate charge	VCC = 300V, IC = 20A, VGE = 15V	—	60	—	nC
VFM	Forward voltage drop	IF = 20A, Clamp diode part	—	—	1.5	V
R _{th(j-f)Q} (Note. 5)	Thermal resistance	IGBT part	—	—	2.2	°C/W
R _{th(j-f)R} (Note. 5)		Clamp diode part	—	—	3.6	°C/W

CONVERTER PART

Symbol	Parameter	Condition	Limits			Unit
			Min.	Typ.	Max.	
IRRM	Repetitive reverse current	VR = VRRM, T _j = 150°C	—	—	8	mA
VFM	Forward voltage drop	IF = 20A	—	—	1.5	V
R _{th(j-f)} (Note. 5)	Thermal resistance	Per 1/6 module	—	—	3.6	°C/W

Note 1. IE, VEC, trr, Qrr & die/dt represent characteristics of the anti-parallel, emitter to collector free-wheel diode.

2. Pulse width and repetition rate should be such that the device junction temp. (T_j) does not exceed T_{jmax} rating.

3. Junction temperature (T_j) should not increase beyond 150°C.

4. Pulse width and repetition rate should be such as to cause negligible temperature rise.

5. Thermal resistance is specified under following conditions.

- The conductive grease applied, between module and fin.
- Al plate is used as fin.

CM20MD-12H

MEDIUM POWER SWITCHING USE
INSULATED TYPE

PERFORMANCE CURVES

OUTPUT CHARACTERISTICS (TYPICAL)

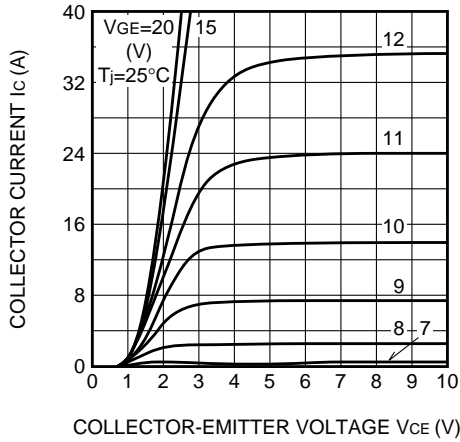

TRANSFER CHARACTERISTICS (TYPICAL)

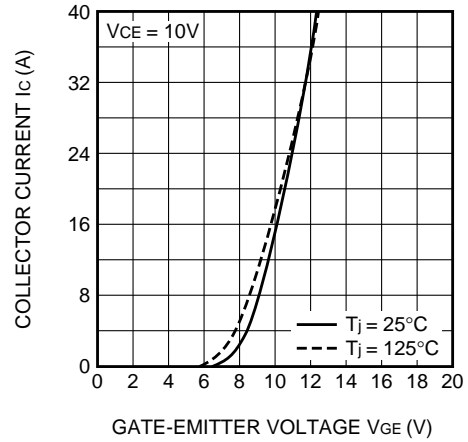

COLLECTOR-EMITTER SATURATION VOLTAGE CHARACTERISTICS (TYPICAL)

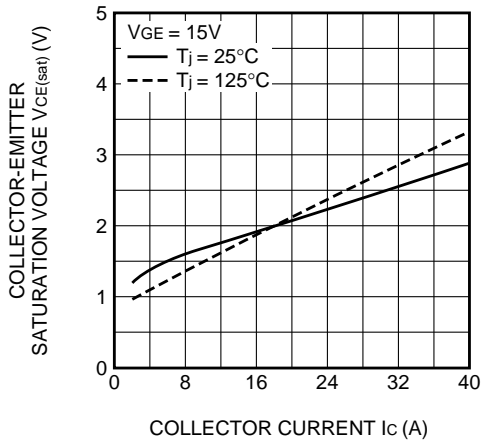

COLLECTOR-EMITTER SATURATION VOLTAGE CHARACTERISTICS (TYPICAL)

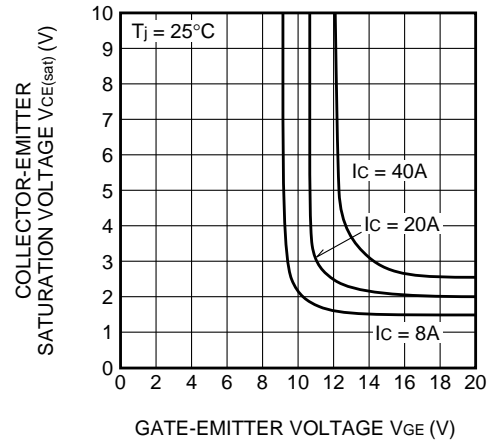

FREE-WHEEL DIODE FORWARD CHARACTERISTICS (TYPICAL)

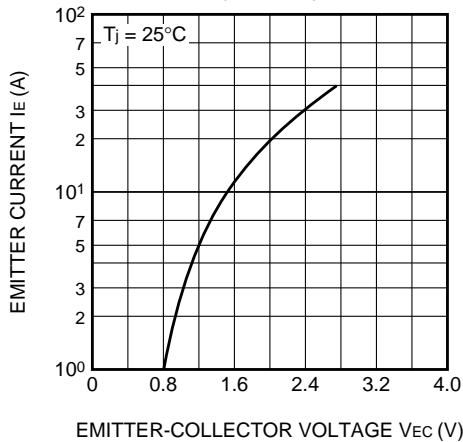

CAPACITANCE VS. Vce (TYPICAL)

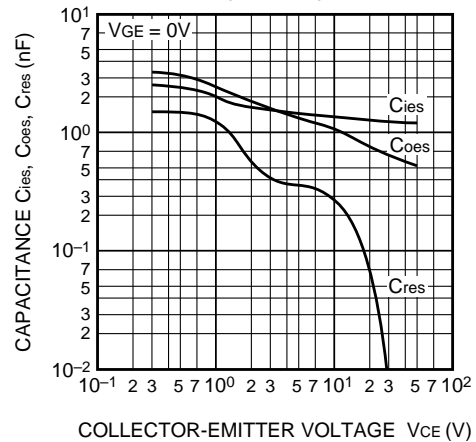

CM20MD-12H

MEDIUM POWER SWITCHING USE
INSULATED TYPE

HALF-BRIDGE SWITCHING CHARACTERISTICS (TYPICAL)

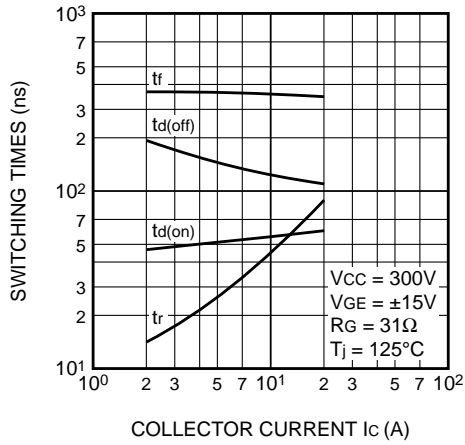

REVERSE RECOVERY CHARACTERISTICS OF FREE-WHEEL DIODE (TYPICAL)

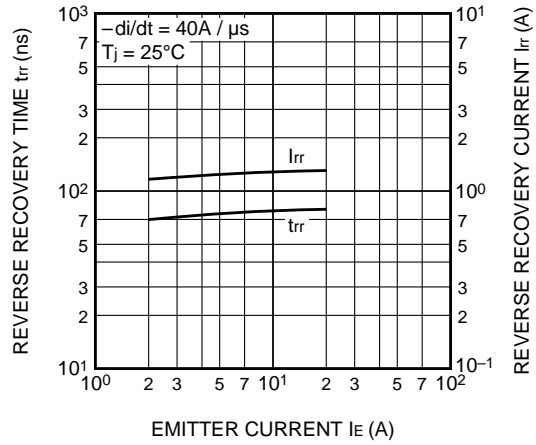

TRANSIENT THERMAL IMPEDANCE CHARACTERISTICS (IGBT part)

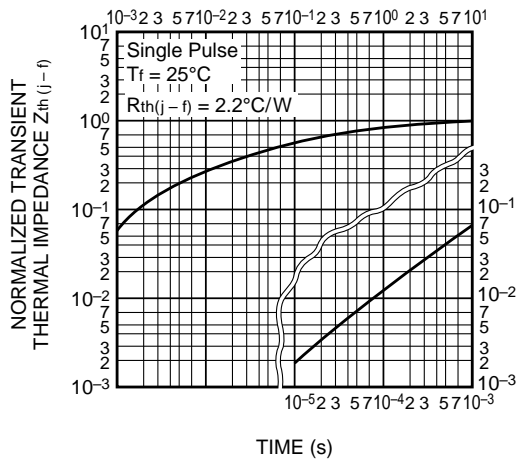

TRANSIENT THERMAL IMPEDANCE CHARACTERISTICS (FWDi part)

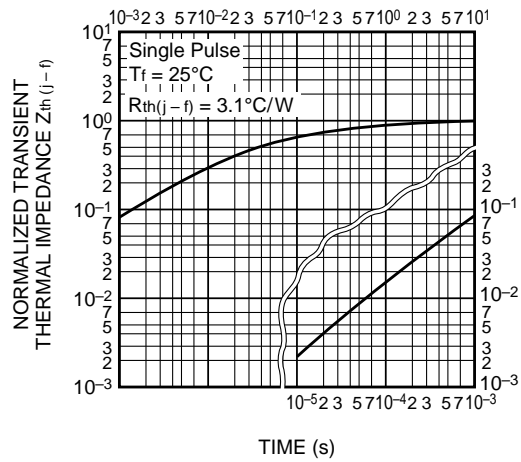

V_{GE} - GATE CHARGE (TYPICAL)

