

Description

The μ PD65000 (CMOS-3) series of gate arrays are low-power, high-speed devices featuring 2-micron silicon gate CMOS technology. The basic cell on the chip consists of four transistors, two P-channel and two N-channel, with double-layer metal interconnects. See figures 1 and 2.

Gate arrays are available in a variety of sizes (800 to 11,250 cells) and package types.

Gate arrays are intended for customers seeking cost effective alternatives. With gate arrays, customers can reduce component count and board size so that they can be more competitive in the markets they serve. NEC's gate array program allows a customized IC to be developed quickly and at a small fraction of the cost of a full custom development program.

NEC's comprehensive CAD support system and master slice system significantly reduce the time and expense usually associated with semicustom devices. Normal turnaround time, after logic validation, is only 8 to 12 weeks. Advanced CAD tools, such as logic simulation, automatic placement and routing, delay simulation, and test program generation ensure accurate error-free designs of all NEC gate arrays.

Features

- High speed: 2.0 ns/gate (with fan-out of 3 and 3-mm wiring)
- Low power: 20 μ W/gate/MHz
- Quick turnaround time: 8 - 12 weeks
- Simple interface to customer's circuit diagram and test pattern sheets
- Fully supported by advanced CAD
 - Logic simulation
 - Automatic placement and routing
 - Test program generation
 - Delay simulation
- Direct access to CAD simulation
 - Designers can use their own terminals through a local network to an NEC design center for logic simulation
- Four types of output buffers
 - Normal
 - Open-drain
 - Three-state
 - Bidirectional
- Wide choice of DIP, QIP, PGA, and flat packages to suit unique applications

Figure 1. CMOS Gate Array Chip Layout

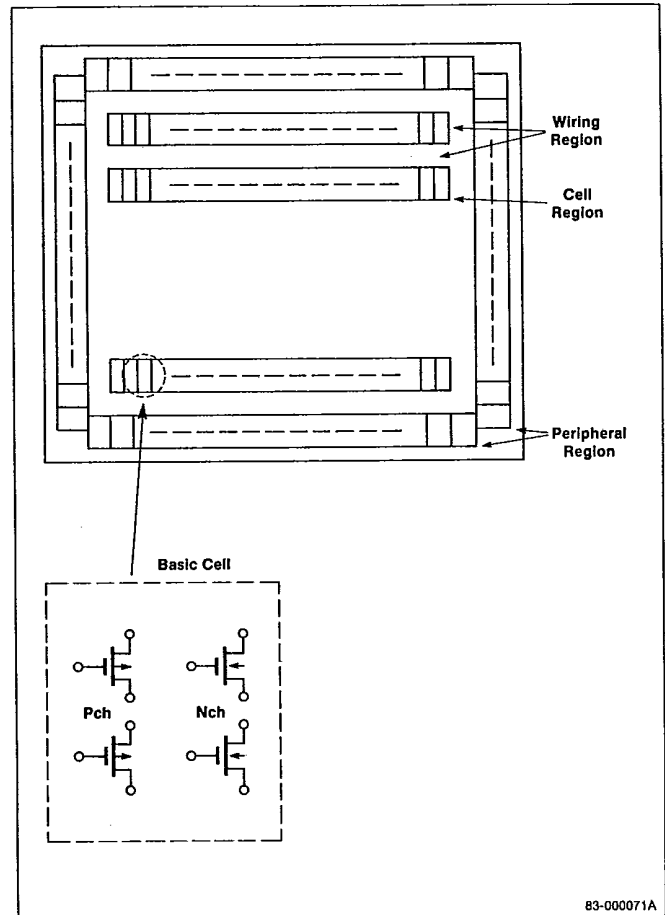
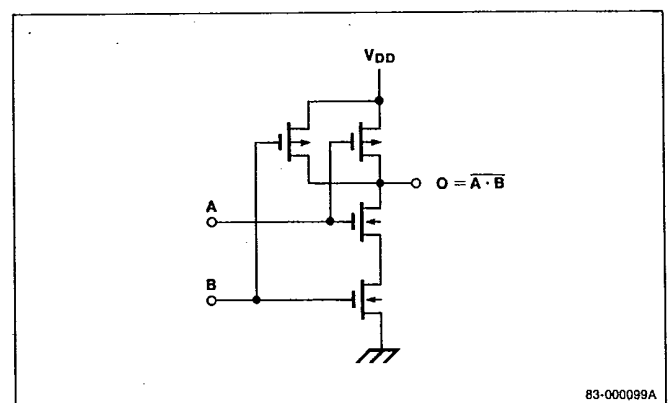

Figure 2. Cell Configured as a Two-Input NAND Gate



μPD65000 (CMOS-3) SERIES 2-MICRON

NEC

Absolute Maximum Ratings

T_A = +25°C

Power supply voltage, V _{DD}	-0.5 to +7.0 V
Input voltage, V _I	-0.5 V to V _{DD} + 0.5 V
Output current, I _O	10 mA
Operating temperature, T _{OP}	-40 to +85°C
Storage temperature, T _{STG}	-65 to +150°C

Comment: Exposing the device to stresses above those listed in Absolute Maximum Ratings could cause permanent damage. The device is not meant to be operated outside the Recommended Operating Conditions below. Exposure to absolute maximum rating conditions for extended periods may affect device reliability.

Recommended Operating Conditions

T_A = -40 to +85°C

Parameter	Symbol	Limits			Unit	Test Conditions
		Min	Typ	Max		
Power supply voltage	V _{DD}	4.5	5	5.5	V	
Input voltage	V _I	0		V _{DD}	V	
Low-level input voltage	V _{IL}	0		0.3 V _{DD}	V	CMOS level
High-level input voltage	V _{IH}	0.7 V _{DD}		V _{DD}	V	CMOS level
Low-level input voltage	V _{IL}	0		0.8	V	TTL level ¹
High-level input voltage	V _{IH}	2.0		V _{DD}	V	TTL level ¹
Input rise, fall times	t _R , t _F	0		10	μs	

Note: 1. T_A = 0 to +70°C, V_{DD} = 5 V ± 5%

DC Characteristics

T_A = -40 to +85°C; V_{DD} = 5 V ± 10%

Parameter	Symbol	Limits			Unit	Test Conditions
		Min	Typ	Max		
Static current	I _L		0.1	200	μA	V _I = V _{DD} or GND
Dynamic current	I _{DD}		4		μA	1 MHz/cell
Input current	I _I		10 ⁻⁵	10	μA	V _I = V _{DD} or GND
Low-level output current	I _{OL}	3.2	9		mA	V _{OL} = 0.4 V
High-level output current	I _{OH}	1	3		mA	V _{OH} = V _{DD} - 0.4 V
Low-level output voltage	V _{OL}			0.1	V	I _O = 0
High-level output voltage	V _{OH}	V _{DD} - 0.1			V	I _O = 0

AC Characteristics

T_A = -40 to +85°C; V_{DD} = 5 V ± 10%

Parameter	Symbol	Limits			Unit	Test Conditions
		Min	Typ	Max		
Maximum operating frequency	f _{MAX}	DC		50	MHz	
Delay time ¹	t _{PD}		2		ns	Gate
	t _{PD}		3		ns	Input buffer
	t _{PD}		10		ns	Output buffer ²
Output rise time	t _R		8		ns	C _L = 15 pF
Output fall time	t _F		4		ns	C _L = 15 pF

Note: 1. With fan-out of 3 and 3 mm wiring.
2. With C_L = 15 pF

Configuration Data

	μPD65004	μPD65011	μPD65021	μPD65030	μPD65040	μPD65060	μPD65080	μPD65100
Number of cells	888	1,598	2,160	3,312	4,104	6,528	8,056	11,250
Configuration			108 rows x 20 columns	138 rows x 24 columns	152 rows x 27 columns	192 rows x 34 columns	212 rows x 38 columns	250 rows x 45 columns
Number of input buffers	60	71	69	111	120	144	160	188
Number of output buffers	60	71	67	94	116	136	148	168

Figure 3. Example of a Circuit Diagram

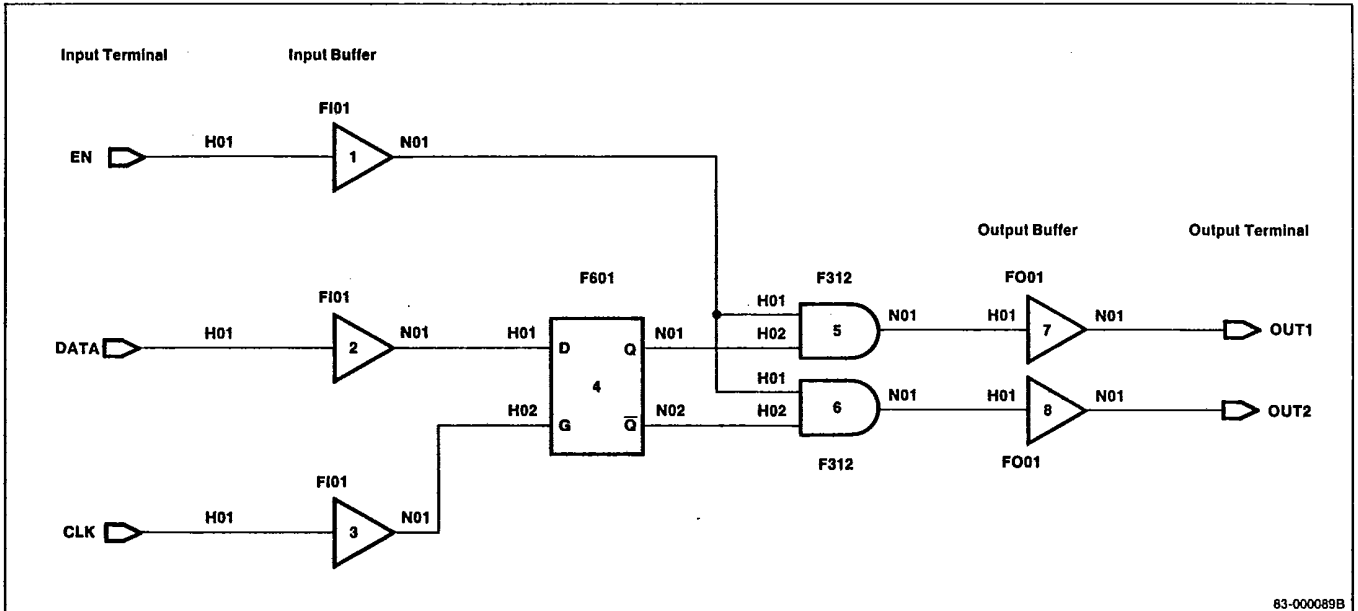

83-00089B

Figure 4. Example of a Test Pattern Chart

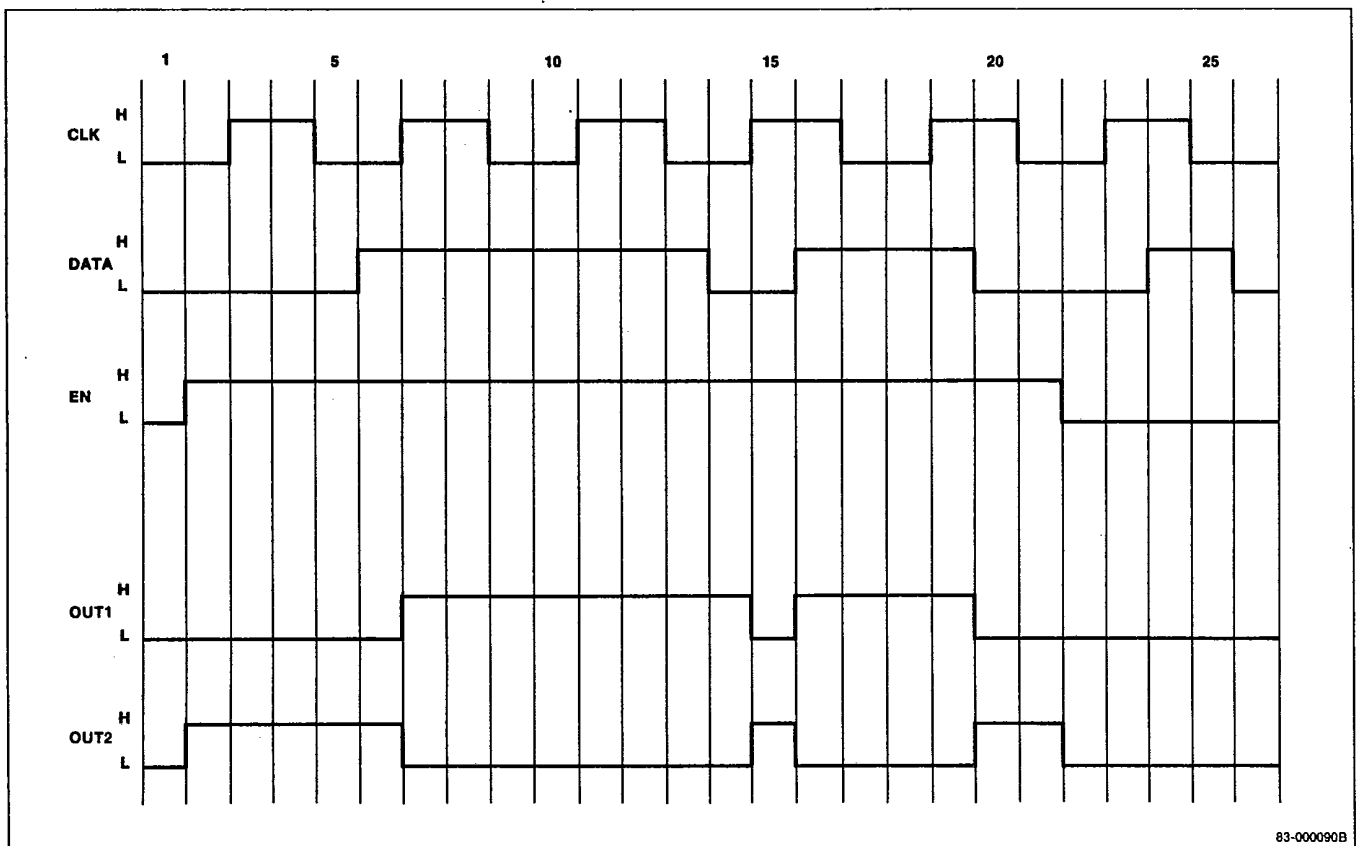

83-00090B

Gate Array Development Process

Figure 5 is a flowchart showing supporting data, development steps, and customer/NEC interface options.

Customer/NEC Interface Options

NEC's computer and communications environment allows gate array designers to select the interface most suitable to their needs.

Standard Data. For the simplest interface, the customer provides a circuit diagram and test patterns. The remainder of the development process is NEC's responsibility.

Macro Converted Data. The customer provides a circuit diagram based on the macros in the NEC Block Library plus test pattern data.

File Generated Data. The customer provides a netlist and test pattern file in NEC compatible format. The netlist is a text file describing circuit interconnections. Data may be sent to NEC on magnetic tape or a floppy disk or transmitted via telephone. The formats and procedures for handling these files will be fully specified by the appropriate NEC Design Center.

Graphic PC Generated Data. Using the PC9800 workstation, a customer can easily generate the necessary netlist and test pattern file. The PC9800 workstation supports schematic capture and limited design rule checking.

VALID, MENTOR, TEGAS-5, LOGICIAN, and Other Simulator Generated Data. For this interface level, the customer performs logic simulation. NEC does the final compatibility check. (Separate manuals describe the various workstation interfaces.)

PG Mask Tape Interface. A separate manual will be issued when this interface becomes available.

TEGAS-5 is the trademark of Calma Company.
LOGICIAN is the trademark of Daisy Systems Corp.

Development Steps

Design Rule Checking. Once the circuit interconnect data is complete, the first step of the logic validation process is the design rule check. Parameters such as cell usage, power dissipation and fan-out loading are determined and checked.

Unit Simulation [Static Logic Simulation]. Here, any coding errors and data conversion errors are eliminated.

Delay Time Simulation. Before automatic placement and routing, delay time simulation gives an accurate estimate of the expected circuit delays.

Automatic Placement and Routing. NEC's advanced software allows up to 95 percent cell utilization without resorting to manual routing.

Final Delay Time Simulation. Here, wire lengths are taken into account. Results of this step provide the customer with an accurate circuit analysis.

Production. If the above steps are completed successfully, design enters actual production followed by 100-percent wafer testing.

Packaging. Successfully tested wafers are divided into individual chips, which are then die-bonded onto the customer-specified package. Chips are then wire-bonded and sealed. The dc parameters and logic functions of each chip are checked in the final test.

Prototype Evaluation. Ten engineering samples are delivered to the customer for the system function test. If customer evaluation is satisfactory, the development process is finished. NEC is ready to begin mass production.

Figure 5. Flowchart for Gate Array Development

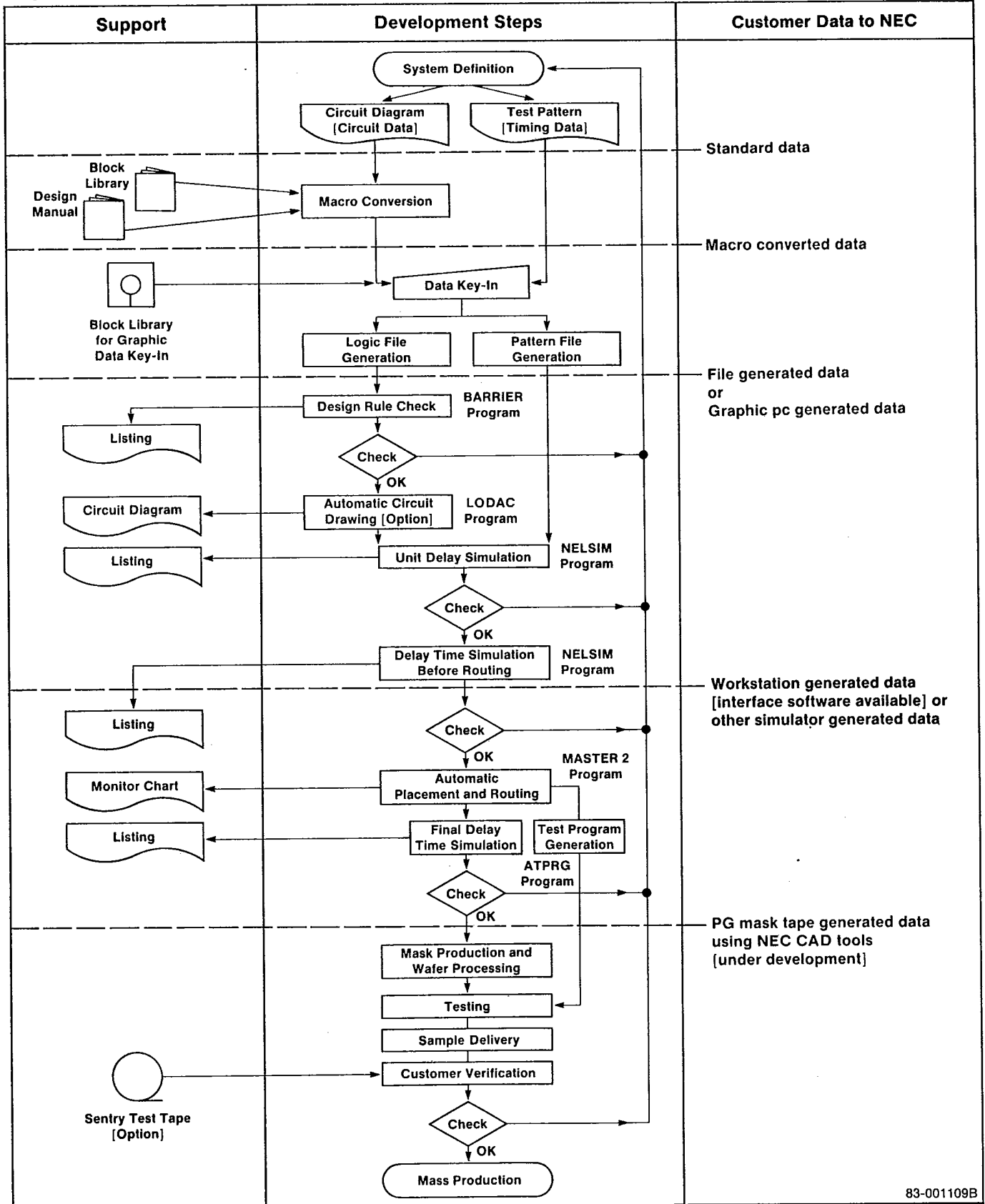

83-001109B

Development Procedure

The semicustom approach of gate arrays offers a unique and effective method of manufacturing ICs at reduced cost and development time. NEC makes this possible by stocking wafers that are completely fabricated except for the final step of interconnection. This provides a designer the freedom of interconnecting the uncommitted components to achieve a unique circuit configuration.

Block Library List

Interface Blocks

Block Type	Function
FI01	Input Buffer (CMOS Level)
FI02	Input Buffer (TTL Level)
FIS1	Input Buffer (Schmitt Trigger Input CMOS Level)
FIS2	Input Buffer (Schmitt Trigger Input TTL Level)
F001	Output Buffer (Normal)
EXT1	Output Buffer (Nch Open Drain)
EXT2	Output Buffer (Pch Open Drain)
B008	Output Buffer (Three-State)
B003	I/O Buffer (Three-State CMOS Level In)
B004	I/O Buffer (Three-State TTL Level In)

Functional Blocks

	Block Type	Function	Cells
Level Generator	F091	H.L. Level Generator	1
Inverter	F101	1-Input (F.O. = 8)	1
	F102	1-Input (F.O. = 16)	1
	F103	1-Input (F.O. = 24)	2
	F104	1-Input (F.O. = 32)	2
Buffer	F111	1-Input (F.O. = 8)	1
	F112	1-Input (F.O. = 16)	2
	F113	1-Input (F.O. = 24)	2
	F114	1-Input (F.O. = 32)	3
NOR	F202	2-Input NOR Gate	1
	F203	3-Input NOR Gate	2
	F204	4-Input NOR Gate	2
	F208	8-Input NOR Gate	7
OR	F212	2-Input OR Gate	2
	F213	3-Input OR Gate	2
	F214	4-Input OR Gate	3

Essential Documents

- Contract and nondisclosure agreement
- Circuit diagram based on the NEC Block Library
- Interconnection data file (LOGINC)
- Test data pattern file (LOGPAT)
- Pin assignment (if required)
- Critical path identification (if required)

Functional Blocks [cont]

	Block Type	Function	Cells
NAND	F302	2-Input NAND Gate	1
	F303	3-Input NAND Gate	2
	F304	4-Input NAND Gate	2
	F305	5-Input NAND Gate	3
	F306	6-Input NAND Gate	3
	F308	8-Input NAND Gate	7
	AND	F312	2-Input AND Gate
F313		3-Input AND Gate	2
F314		4-Input AND Gate	3
AND-NOR	F421	2-Wide, 1-2-Input AND-OR-Inverter	2
	F422	3-Wide, 1-1-2-Input AND-OR-Inverter	2
	F423	2-Wide, 1-3-Input AND-OR-Inverter	2
	F424	2-Wide, 2-2-Input AND-OR-Inverter	2
	F425	3-Wide, 2-2-2-Input AND-OR-Inverter	3
	F426	2-Wide, 3-3-Input AND-OR-Inverter	3
	F429	4-Wide, 2-2-2-Input AND-OR-Inverter	4
OR-NAND	F442	2-Wide, 4-4-Input AND-OR-Inverter	4
	F431	2-Wide, 1-2-Input OR-AND-Inverter	2
	F432	2-Wide, 2-2-Input OR-AND-Inverter	2
	F433	2-Wide, 1-3-Input OR-AND-Inverter	2
	F434	2-Wide, 2-2-Input OR-AND-Inverter	2
	F435	2-Wide, 2-3-Input OR-AND-Inverter	3
	F436	2-Wide, 3-3-Input OR-AND-Inverter	3
Driver	F454	4-Wide, 2-2-2-Input OR-AND-Inverter	4
	F501	Clock Driver	1
	F502	Clock Driver (Dual)	2
	F503	Clock Driver (With Buffer)	2
EX-OR	F504	Clock Driver (Dual with Buffer)	4
	F505	2-Wide, 1-2-Input NAND-AND-Inverter	2
EX-OR	F511	2-Input Exclusive-OR Gate	3
EX-NOR	F512	2-Input Exclusive-NOR Gate	3

Functional Blocks [cont]

	Block Type	Function	Cells
Full Adder	F521	1-Bit Full Adder	7
	F523	4-Bit Full Adder	34
Three-State Buffer	F531	Three-State Buffer (EN) (F.O. = 8)	3
	F532	Three-State Buffer ($\overline{\text{EN}}$) (F.O. = 8)	3
	F533	Three-State Buffer (EN) (F.O. = 24)	4
Multiplexer	F569	8-1 Multiplexer	17
	F570	4-1 Multiplexer	8
	F571	2-1 Multiplexer	4
	F572	Quad 2-1 Multiplexer	11
Parity Generator	F581	8-Bit Odd Parity Generator	18
	F582	8-Bit Even Parity Generator	18
Latch	F595	R-S Latch	4
	F601	D-Latch	3
	F602	D-Latch (with Reset)	4
	F603	D-Latch (with $\overline{\text{Reset}}$)	4
	F604	D-Latch $\overline{\text{C}}$	3
	F605	D-Latch $\overline{\text{C}}$ with Reset	4
	F901	4-Bit D-Latch	10
	F902	8-Bit D-Latch	18
Flip-Flop	F611	D-Type	5
	F612	D-Type with Reset	7
	F613	D-Type with Set	7
	F614	D-Type with Set-Reset	7
	F615	D-Type with $\overline{\text{Reset}}$	7
	F616	D-Type with Set	7
	F617	D-Type with $\overline{\text{Set-Reset}}$	7
	F631	D-Type $\overline{\text{C}}$	5
	F635	D-Type $\overline{\text{C}}$ with Reset	7
	F636	D-Type $\overline{\text{C}}$ with Set	7
	F637	D-Type $\overline{\text{C}}$ with Set-Reset	7
	F641	D-Type (Buffered Out)	6
	F642	D-Type (Buffered Out) with Reset	8
	F643	D-Type (Buffered Out) with Set	8
	F644	D-Type (Buffered Out) with Set-Reset	8
	F645	D-Type (Buffered Out) with Reset	8
	F646	D-Type (Buffered Out) with Set	8
	F647	D-Type (Buffered Out) with Set-Reset	8
	F661	D-Type (Buffered Out) $\overline{\text{C}}$	6
	F665	D-Type (Buffered Out) $\overline{\text{C}}$ with Reset	8
	F666	D-Type (Buffered Out) $\overline{\text{C}}$ with Set	8
	F667	D-Type (Buffered Out) $\overline{\text{C}}$ with Set-Reset	8

	Block Type	Function	Cells
Flip-Flop	F922	4-Bit D-Type with Reset	26
	F691	Serial/Parallel Shift Resister	5
	F911	4-Bit Shift Resister with Reset	26
	F912	4-Bit Serial/Parallel Shift Resister	24
	F913	4-Bit Parallel Shift Resister with Reset	35
	F712	Toggle with Reset	7
	F713	Toggle with Set	7
	F714	Toggle with Set-Reset	7
	F715	Toggle with $\overline{\text{Reset}}$	7
	F716	Toggle with Set	7
	F717	Toggle with Set-Reset	7
	F735	Toggle ($\overline{\text{T}}$) with Reset	7
	F736	Toggle ($\overline{\text{T}}$) with Set	7
	F737	Toggle ($\overline{\text{T}}$) with Set-Reset	7
	F742	Toggle (Buffered Out) with Reset	8
	F743	Toggle (Buffered Out) with Set	8
	F744	Toggle (Buffered Out) with Set-Reset	8
	F745	Toggle (Buffered Out) with $\overline{\text{Reset}}$	8
	F746	Toggle (Buffered Out) with Set	8
	F747	Toggle (Buffered Out) with Set-Reset	8
	F765	Toggle (Buffered Out) ($\overline{\text{T}}$) with Reset	8
	F766	Toggle (Buffered Out) ($\overline{\text{T}}$) with Set	8
	F767	Toggle (Buffered Out) ($\overline{\text{T}}$) with Set-Reset	8
	F791	Toggle with Set-Reset and Tog-EN	9
	F792	Toggle ($\overline{\text{T}}$) with Set-Reset and Tog-EN	9
	F771	JK F/F	9
	F772	JK F/F with Reset	11
F773	JK F/F with Set	11	
F774	JK F/F with Set-Reset	11	
F775	JK F/F with $\overline{\text{Reset}}$	11	
F776	JK F/F with Set	11	
F777	JK F/F with Set-Reset	11	
F781	JK F/F $\overline{\text{C}}$	9	
F785	JK F/F $\overline{\text{C}}$ with Reset	11	
F786	JK F/F $\overline{\text{C}}$ with Set	11	
F787	JK F/F $\overline{\text{C}}$ with Set-Reset	11	
Counter	F961	4-Bit Sync Binary Counter with Reset	54
	F962	4-Bit Sync Binary Counter with $\overline{\text{Reset}}$	34
Decoder	F981	2-to-4 Decoder with EN	9
	F982	3-to-8 Decoder with EN	20
Comparator	F985	4-Bit Magnitude Comparator	46
Misc	BUSA	Bus Array	

Operating Characteristics

Output Voltage vs Input Voltage [CMOS Input]

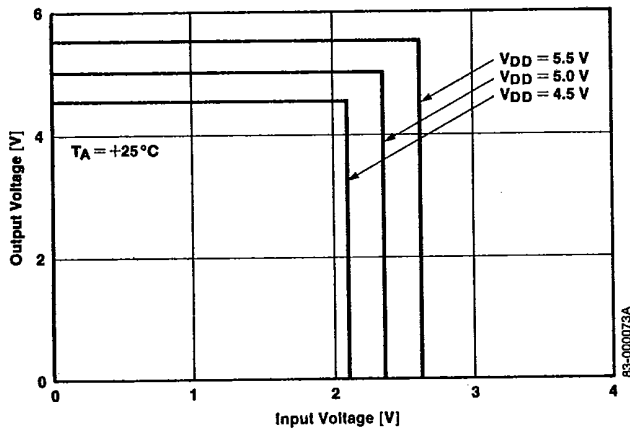

Output Voltage vs Input Voltage [TTL Input]

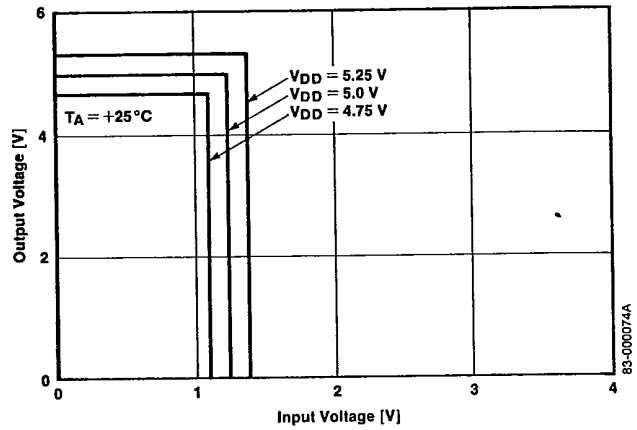

Output Current vs Output Voltage [N-Channel]

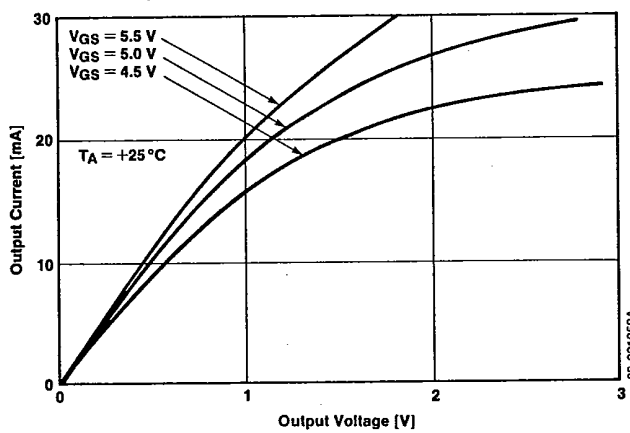

Output Current vs Output Voltage [P-Channel]

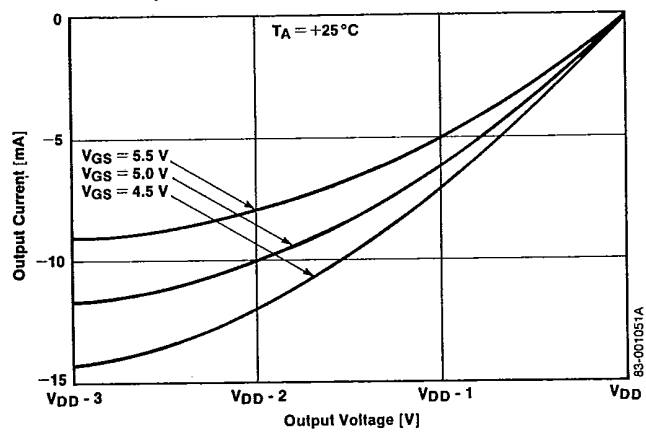

Delay Time vs Fan-Outs [NAND]

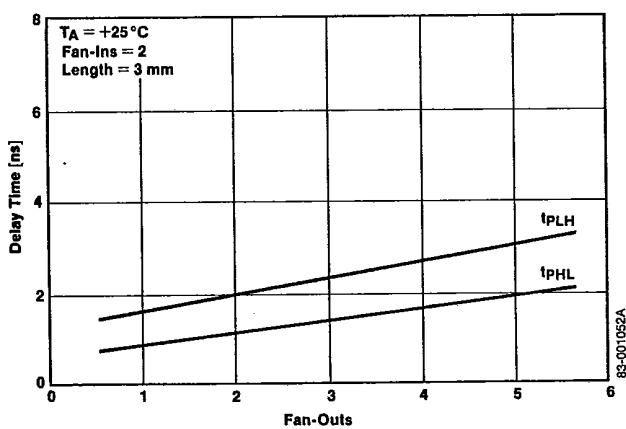

Delay Time vs Fan-Outs [NOR]

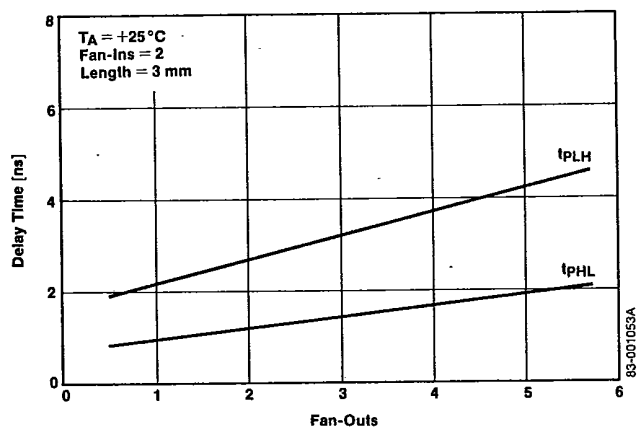

Operating Characteristics (cont)

Delay Time vs Length [NAND]

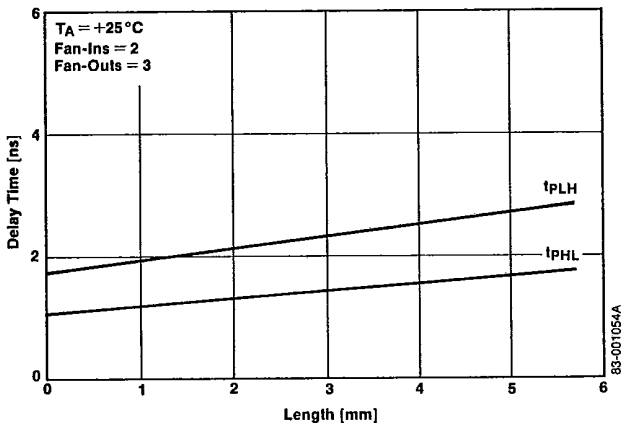

Delay Time vs Length [NOR]

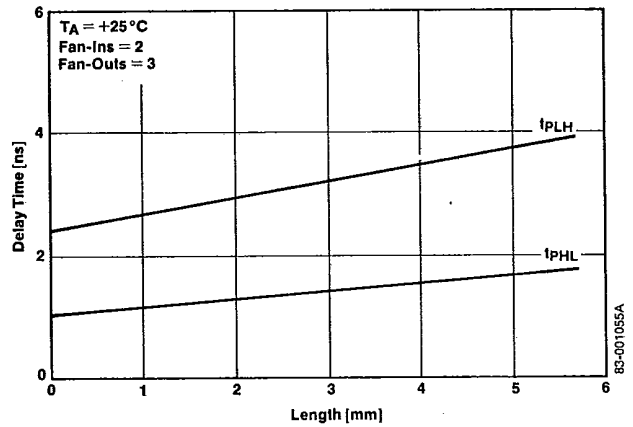

Delay Time vs Supply Voltage [NAND]

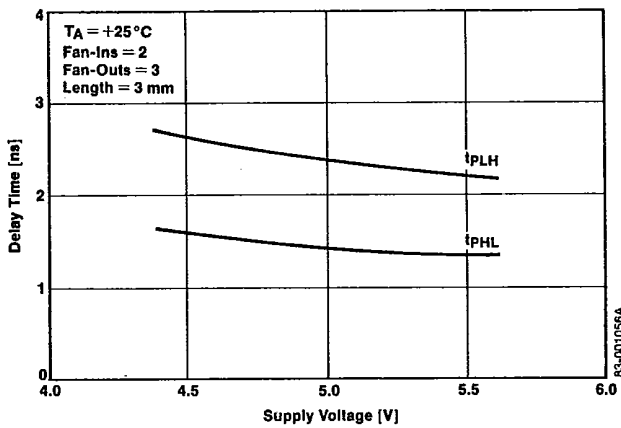

Delay Time vs Ambient Temperature [NAND]

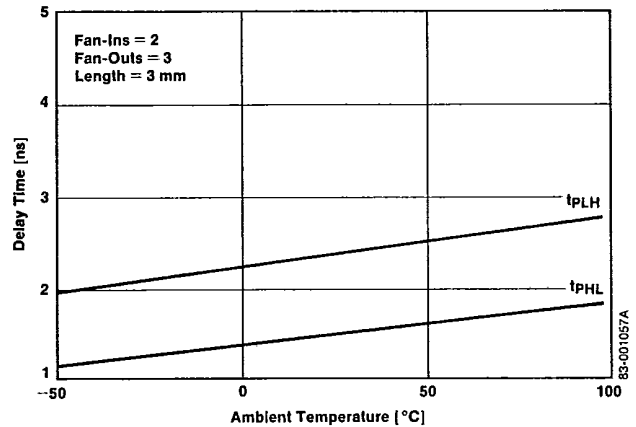

Delay Time vs Supply Voltage [Input Buffer]

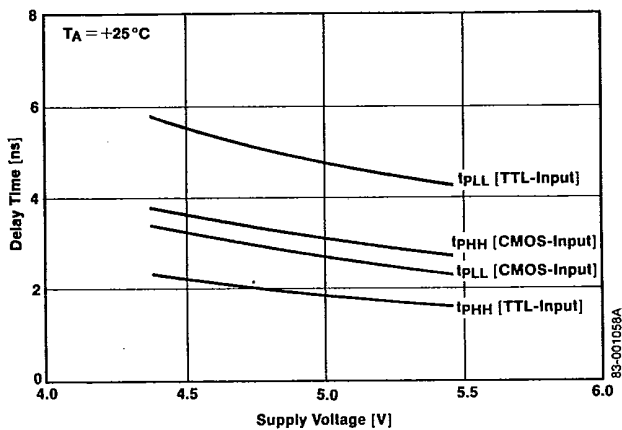

Delay Time vs Load Capacitance [Output Buffer]

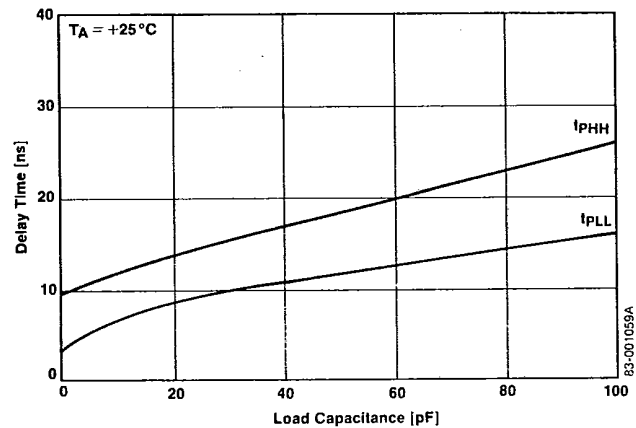

Operating Characteristics (cont)

**Input Voltage vs Ambient Temperature
[CMOS Schmitt Trigger Input]**

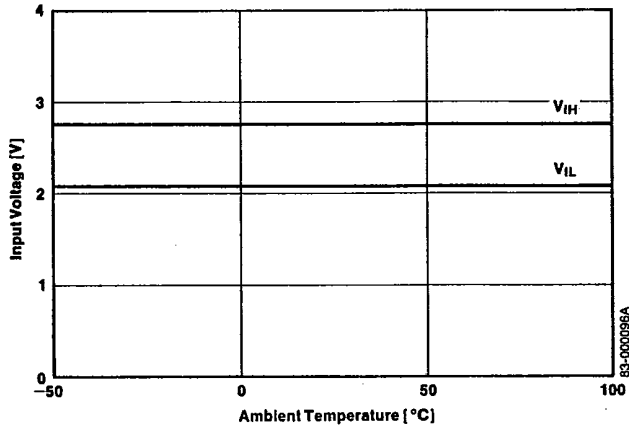

**Input Voltage vs Ambient Temperature
[TTL Schmitt Trigger Input]**

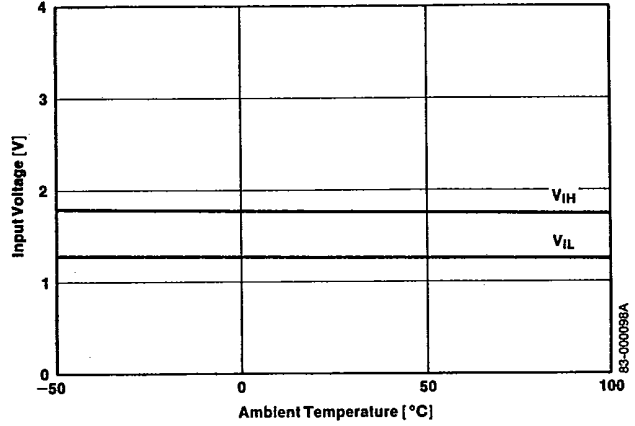

**Input Voltage vs Supply Voltage
[CMOS Schmitt Trigger Input]**

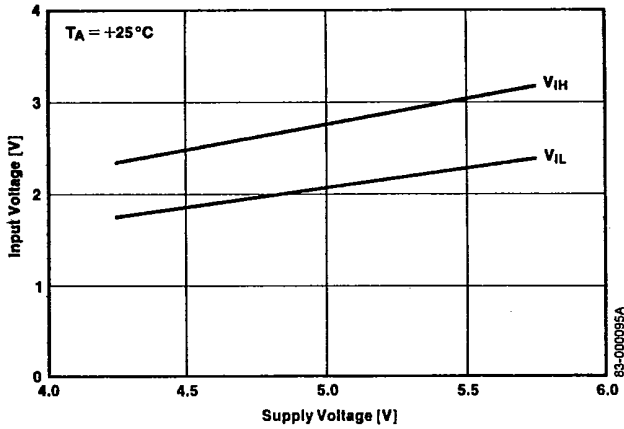

**Input Voltage vs Supply Voltage
[TTL Schmitt Trigger Input]**

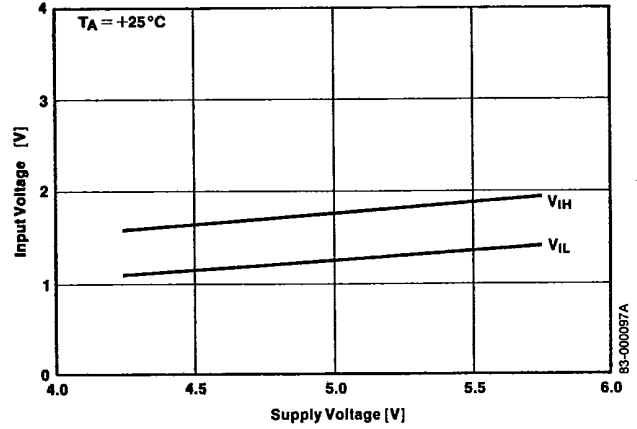

Operating Characteristics (cont)

Delay Time vs Supply Voltage [NOR]

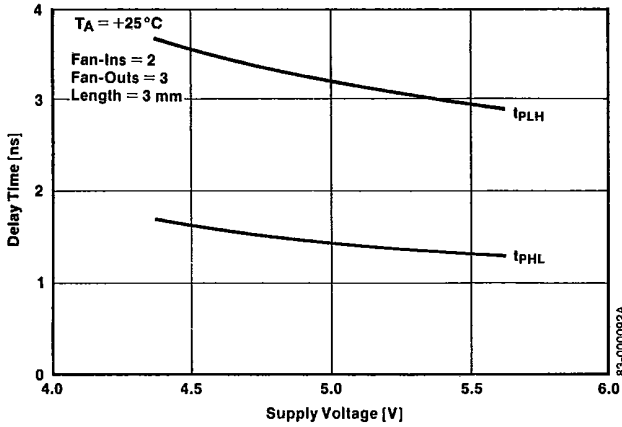

Delay Time vs Ambient Temperature [NOR]

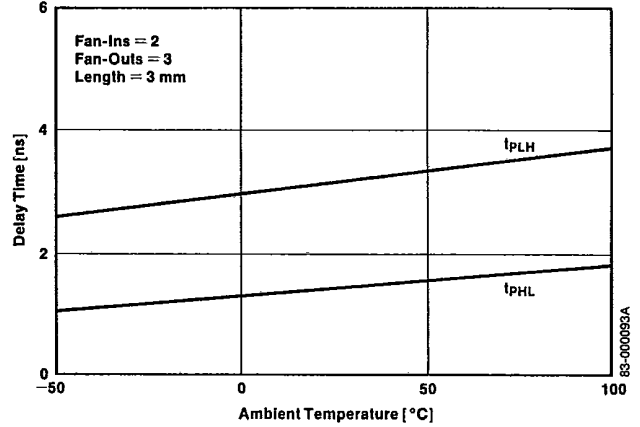

Delay Time vs Fan-Outs [Input Buffer]

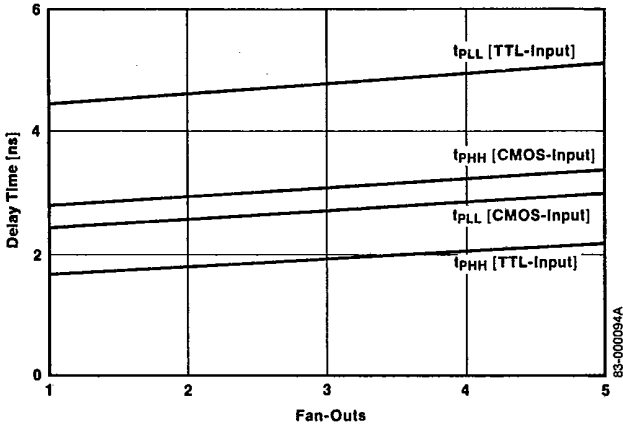

Rise and Fall Times vs Load Capacitance

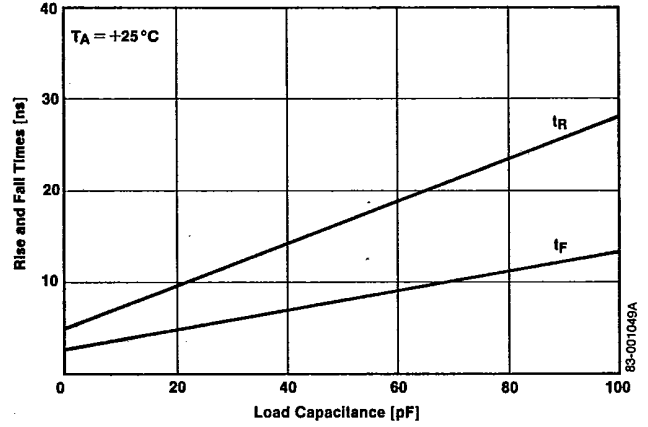

μPD65000 (CMOS-3) SERIES 2-MICRON

Packaging Information

The 2-micron gate arrays are available in a wide variety of packages to accommodate unique applications. The following table shows the package types in the

μPD65000 (CMOS-3) series. (DIP = Dual in-line package; PGA = Pin grid array.)

Package Availability

Package Type	μPD65004	μPD65011	μPD65021	μPD65030	μPD65040	μPD65060	μPD65080	μPD65100
DIP								
24-Pin	•	•						
28-Pin	•	•	•					
40-Pin	•	•	•	•	•			
48-Pin	•	•	•	•	•			
64-Pin (shrink)		•	•	•	•			
Flat								
44-Pin	•	•	•					
52-Pin	•	•	•		•			
64-Pin	•	•	•	•	•	Δ		
80-Pin		•	•	•	•	Δ		
100-Pin				•	•			
PGA								
72-Pin			•	•	•	•	•	•
132-Pin			Δ	•	•	•	•	•
176-Pin						•	•	•
208-Pin								•

Δ Under Development

Package Marking

Example of Plastic Package

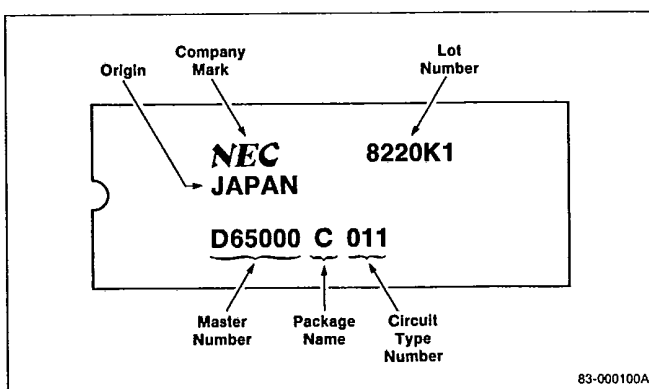

NEC
NEC Electronics Inc.
CORPORATE HEADQUARTERS

401 Ellis Street
P.O. Box 7241
Mountain View, CA 94039
TEL 415-980-6000
TWX 910-379-6985

The information in this document is subject to change without notice. NEC Electronics Inc. makes no warranty of any kind with regard to this material, including, but not limited to, the implied warranties of merchantability and fitness for a particular purpose. NEC Electronics Inc. assumes no responsibility for any errors that may appear in this document. NEC Electronics Inc. makes no commitment to update nor to keep current the information contained in this document. No part of this document may be copied or reproduced in any form or by any means without the prior written consent of NEC Electronics Inc.

NECEL-000246-0185
STOCK NO. 700430