



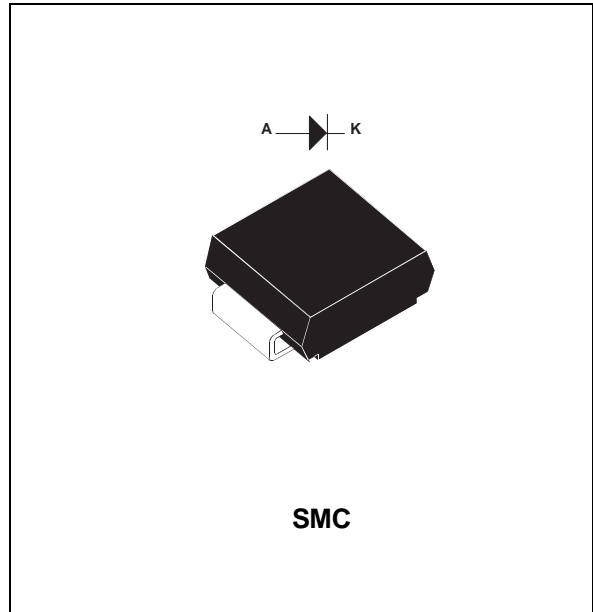
## TURBOSWITCH™ "A". ULTRA-FAST HIGH VOLTAGE DIODE

### MAIN PRODUCTS CHARACTERISTICS

$I_{F(AV)}$	<b>2A</b>
$V_{RRM}$	<b>600V</b>
$t_{rr}$ (typ)	<b>20ns</b>
$V_F$ (max)	<b>1.5V</b>

### FEATURES AND BENEFITS

- SPECIFIC TO "FREEWHEEL MODE" OPERATIONS: FREEWHEEL OR BOOSTER DIODE
- ULTRA-FAST AND SOFT RECOVERY
- VERY LOW OVERALL POWER LOSSES IN BOTH THE DIODE AND THE COMPANION TRANSISTOR
- HIGH FREQUENCY OPERATIONS
- SURFACE MOUNT DEVICE



### DESCRIPTION

The TURBOSWITCH is a very high performance series of ultra-fast high voltage power diodes from 600V to 1200V.

TURBOSWITCH "A" family drastically cuts losses in both the diode and the associated switching IGBT or MOSFET in all "Freewheel Mode" operations and is particularly suitable and efficient

in Motor Control Freewheel applications and in Booster diode applications in Power Factor Control circuitries.

Packaged in SMC surface mount envelope, these 600V devices are particularly intended for use on 240V domestic mains.

### ABSOLUTE MAXIMUM RATINGS

Symbol	Parameter	Value	Unit
$V_{RRM}$	Repetitive peak reverse voltage	600	V
$V_{RSM}$	Non repetitive peak reverse voltage	600	V
$I_{F(RMS)}$	RMS forward current	8	A
$I_{FRM}$	Repetitive peak forward current ( $t_p = 5 \mu s$ , $f = 5kHz$ )	50	A
$T_j$	Maximum operating junction temperature	125	°C
$T_{stg}$	Storage temperature range	- 65 to + 150	°C

## STTA206S

### THERMAL AND POWER DATA

Symbol	Parameter	Conditions	Value	Unit
$R_{th(j-l)}$	Junction to lead		21	°C/W
$P_1$	Conduction power dissipation (see fig. 2)	$I_{F(AV)} = 1.5A$ $\delta = 0.5$ $T_{lead} = 72^\circ C$	2.5	W
$P_{max}$	Total power dissipation $P_{max} = P_1 + P_3$ ( $P_3 = 10\% P_1$ )	$T_{lead} = 67^\circ C$	2.8	W

### STATIC ELECTRICAL CHARACTERISTICS (see Fig. 2)

Symbol	Parameter	Test Conditions	Min	Typ	Max	Unit
$V_F$ *	Forward voltage drop	$I_F = 2A$ $T_j = 25^\circ C$ $T_j = 125^\circ C$		1.1	1.75 1.5	V
$I_R$ **	Reverse leakage current	$V_R = 0.8$ $\times V_{RRM}$ $T_j = 25^\circ C$ $T_j = 125^\circ C$		400	20 1200	$\mu A$

Test pulses widths : \*  $t_p = 380 \mu s$ , duty cycle < 2%

\*\*  $t_p = 5 ms$ , duty cycle < 2%

### DYNAMIC ELECTRICAL CHARACTERISTICS

#### TURN-OFF SWITCHING (see Fig. 3)

Symbol	Parameter	Test Conditions	Min	Typ	Max	Unit
$t_{rr}$	Reverse recovery time	$T_j = 25^\circ C$ $I_F = 0.5 A$ $I_R = 1A$ $I_{rr} = 0.25A$ $I_F = 1 A$ $di_F/dt = -50A/\mu s$ $V_R = 30V$		20	50	ns
$I_{RM}$	Maximum recovery current	$T_j = 125^\circ C$ $V_R = 400V$ $I_F = 2A$ $di_F/dt = -16 A/\mu s$ $di_F/dt = -50 A/\mu s$		2.0	1.2	A
S factor	Softness factor	$T_j = 125^\circ C$ $V_R = 400V$ $I_F = 2A$ $di_F/dt = -50 A/\mu s$		TBD		-

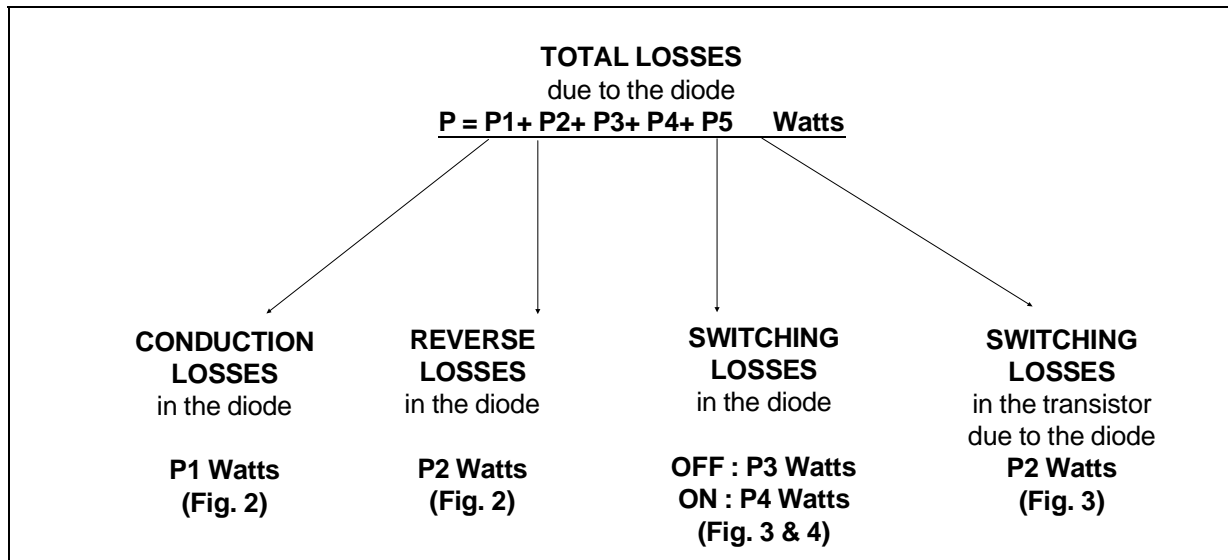
#### TURN-ON SWITCHING (see Fig.8)

Symbol	Parameter	Test Conditions	Min	Typ	Max	Unit
$t_{fr}$	Forward recovery time	$T_j = 25^\circ C$ $I_F = 1 A$ $di_F/dt = 8 A/\mu s$			500	ns
$V_{Fp}$	Peak forward voltage	measured at, $1.1 \times V_F$ max			10	V

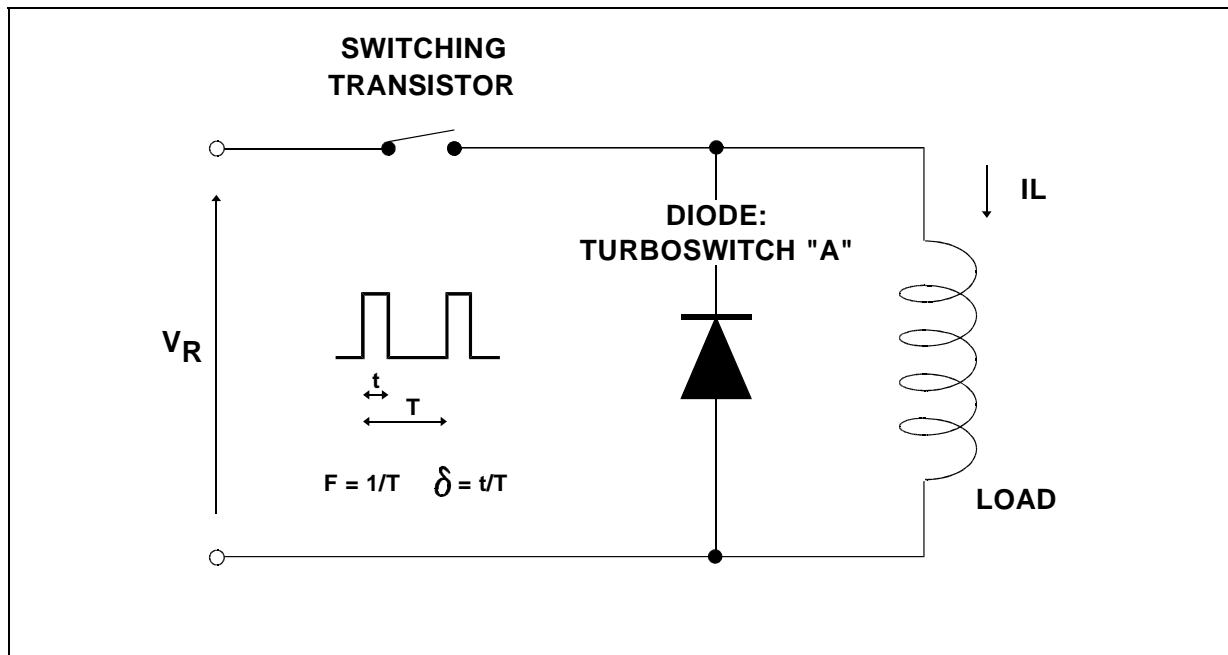
**APPLICATION DATA**

The TURBOSWITCH™ "A" is especially designed to provide the lowest overall power losses in any "Freewheel Mode" application (see fig. 1) considering both the diode and the companion transistor, thus optimizing the overall performance in the end application.

The way of calculating the power losses is given below :

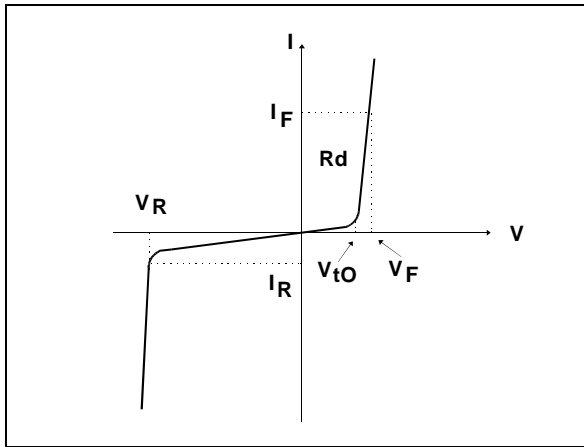


**Fig. 1 : "FREEWHEEL" MODE**



APPLICATION DATA (Cont'd)

Fig. 2 : STATIC CHARACTERISTICS



Conduction losses :

$$P1 = V_{t0} \times I_{F(AV)} + R_d \times I_{F(RMS)}^2$$

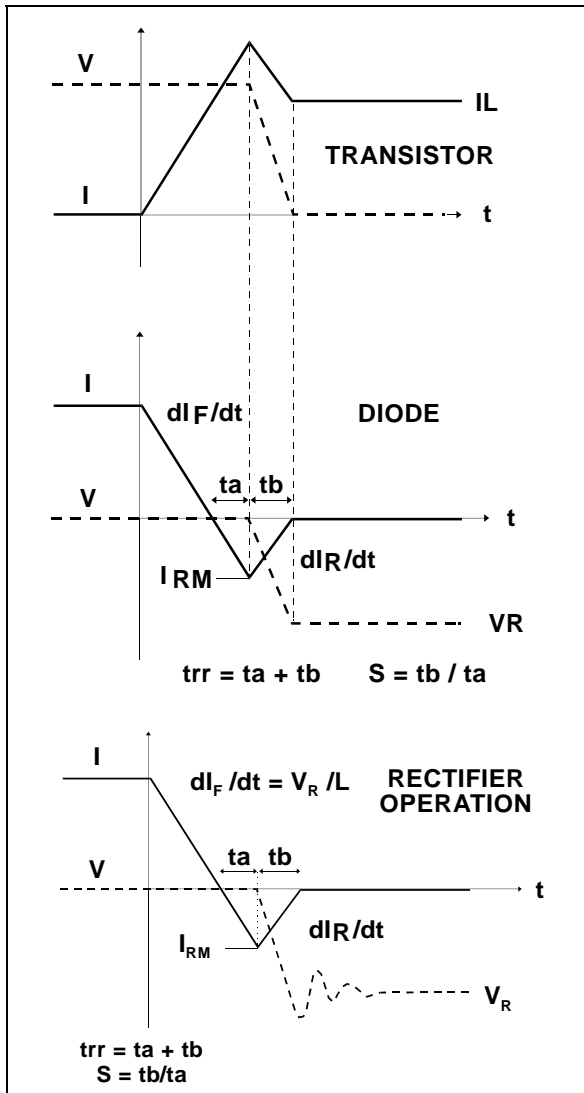
with

$$\begin{aligned} V_{t0} &= 1.15 \text{ V} \\ R_d &= 0.175 \text{ Ohm} \\ &\text{(Max values at 125°C)} \end{aligned}$$

Reverse losses :

$$P2 = V_R \times I_R \times (1 - \delta)$$

Fig. 3 : TURN-OFF CHARACTERISTICS



Turn-on losses :

(in the transistor, due to the diode)

$$\begin{aligned} P5 &= \frac{V_R \times I_{RM}^2 \times (3 + 2 \times S) \times F}{6 \times dI_F/dt} \\ &+ \frac{V_R \times I_{RM} \times I_L \times (S + 2) \times F}{2 \times dI_F/dt} \end{aligned}$$

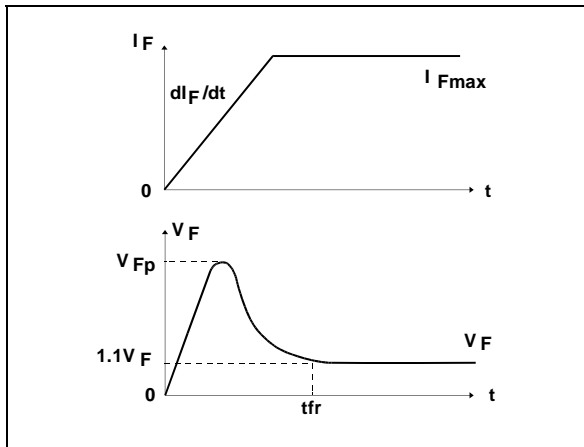
Turn-off losses (in the diode) :

$$P3 = \frac{V_R \times I_{RM}^2 \times S \times F}{6 \times dI_F/dt}$$

P3 and P5 are suitable for power MOSFET and IGBT

APPLICATION DATA (Cont'd)

Fig. 4 : TURN-ON CHARACTERISTICS



Ratings and characteristics curves are ON GOING.

Turn-on losses :

$$P4 = 0.4 (VFp - VF) \times IFmax \times tfr \times F$$

Fig. 5: Conduction losses versus average current.

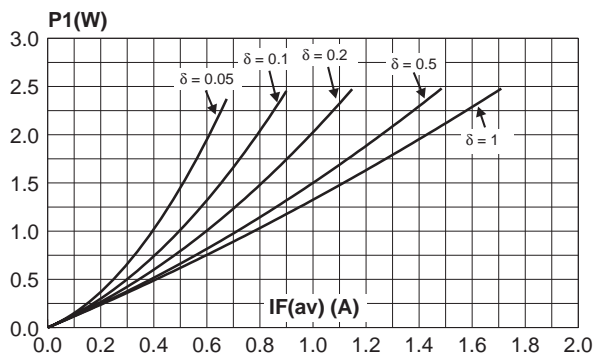


Fig. 7: Switching ON losses versus dIF/dt.

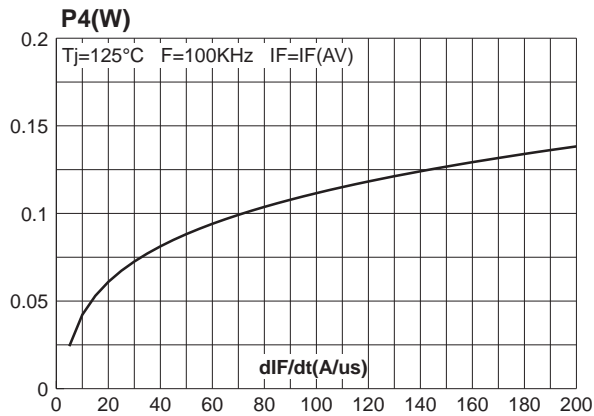


Fig. 6: Switching OFF losses versus dIF/dt.

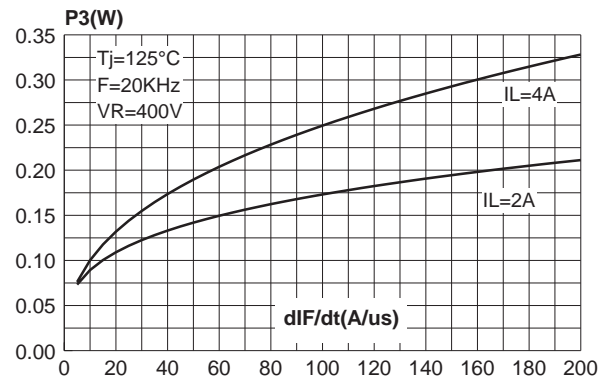
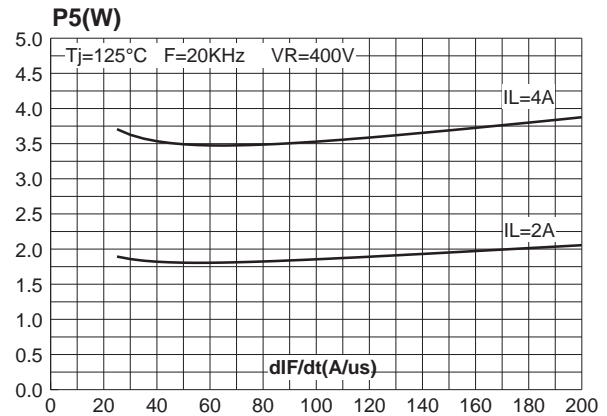
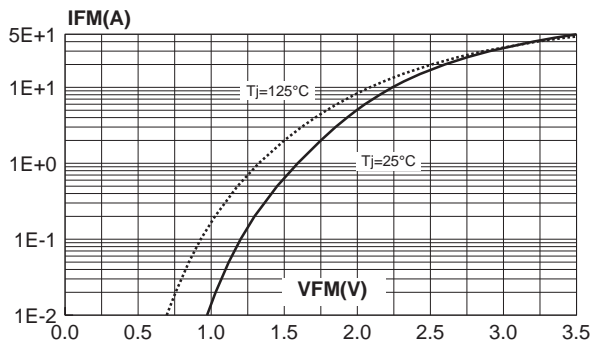


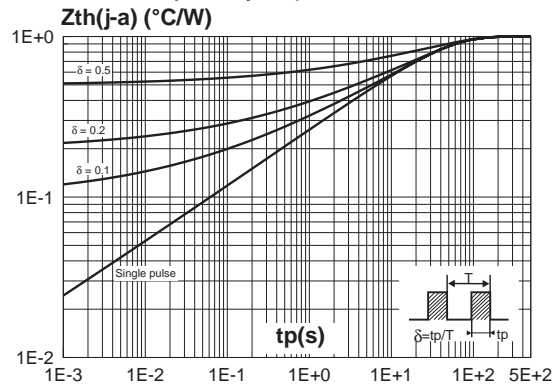
Fig. 8: Switching losses in transistor due to the diode.



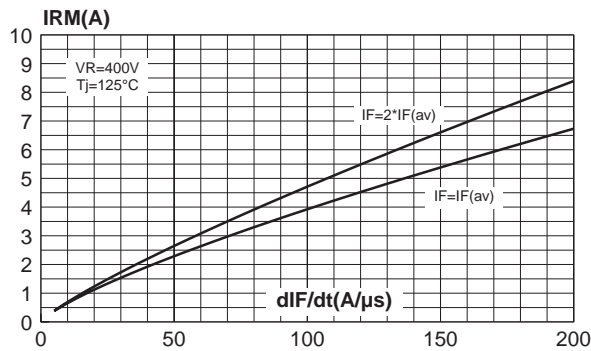
**Fig. 9:** Forward voltage drop versus forward current (maximum values).



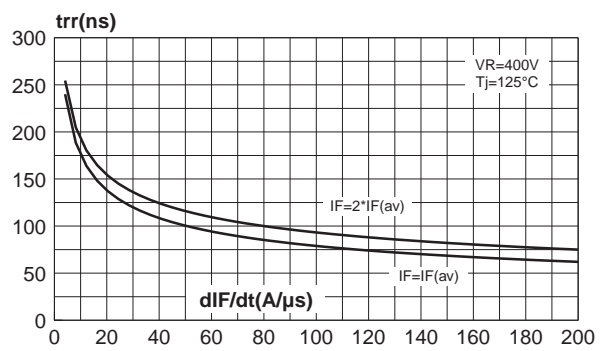
**Fig. 10:** Relative variation of thermal impedance junction to ambient versus pulse duration (recommended pad layout).



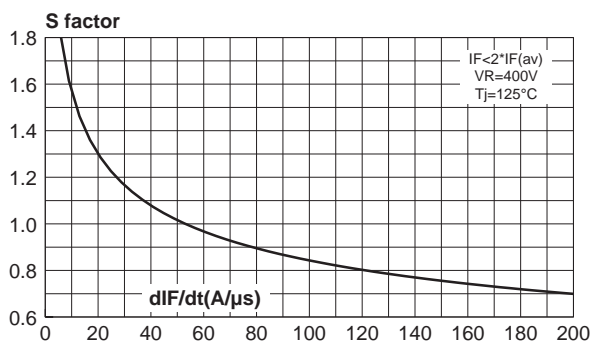
**Fig. 11:** Peak reverse recovery current versus dIF/dt (90% confidence).



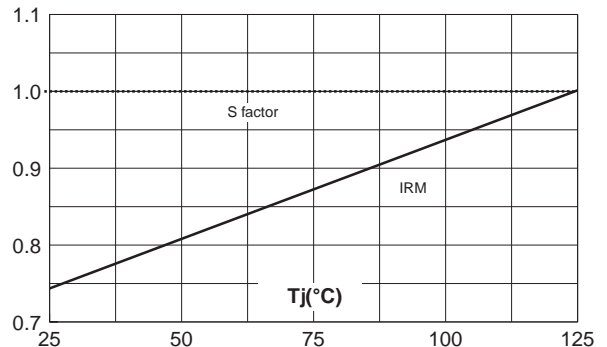
**Fig. 12:** Reverse recovery time versus dIF/dt (90% confidence).



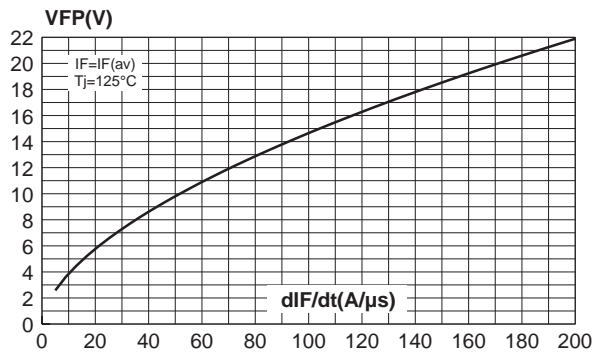
**Fig. 13:** Softness factor (tb/ta) versus dIF/dt (typical values).



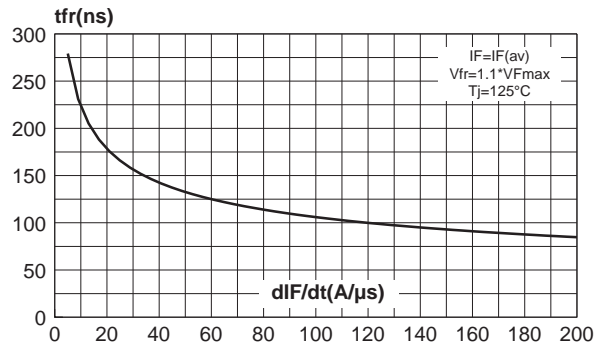
**Fig. 14:** Relative variation of dynamic parameters versus junction temperature (reference Tj=125°C).



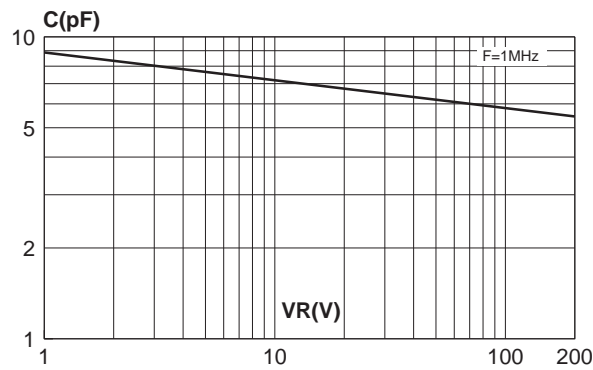
**Fig. 15:** Transient peak forward voltage versus  $dI_F/dt$  (90% confidence).



**Fig. 16:** Forward recovery time versus  $dI_F/dt$  (90% confidence).



**Fig. 17:** Junction capacitance versus reverse voltage applied (typical values).

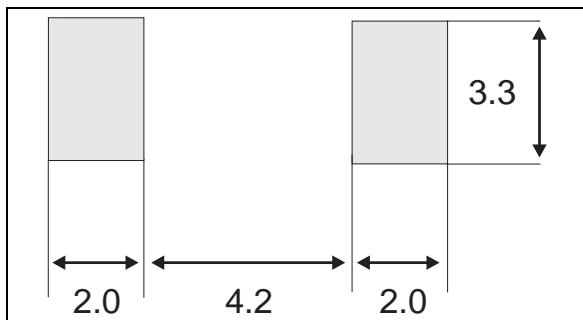


## STTA206S

### PACKAGE MECHANICAL DATA SMC

REF.	DIMENSIONS			
	Millimeters		Inches	
	Min.	Max.	Min.	Max.
A1	1.90	2.45	0.075	0.096
A2	0.05	0.20	0.002	0.008
b	2.90	3.2	0.114	0.126
c	0.15	0.41	0.006	0.016
E	7.75	8.15	0.305	0.321
E1	6.60	7.15	0.260	0.281
E2	4.40	4.70	0.173	0.185
D	5.55	6.25	0.218	0.246

### FOOTPRINT DIMENSIONS (in millimeters)



Type	Marking	Package	Weight	Base qty	Delivery mode
STTA206S	T51	SMC	0.243g	2500	Tape & Reel

- Band indicates cathode
- Epoxy meets UL94, V0

Information furnished is believed to be accurate and reliable. However, STMicroelectronics assumes no responsibility for the consequences of use of such information nor for any infringement of patents or other rights of third parties which may result from its use. No license is granted by implication or otherwise under any patent or patent rights of STMicroelectronics. Specifications mentioned in this publication are subject to change without notice. This publication supersedes and replaces all information previously supplied. STMicroelectronics products are not authorized for use as critical components in life support devices or systems without express written approval of STMicroelectronics.

The ST logo is a registered trademark of STMicroelectronics

© 1999 STMicroelectronics - Printed in Italy - All rights reserved.

STMicroelectronics GROUP OF COMPANIES

Australia - Brazil - China - Finland - France - Germany - Hong Kong - India - Italy - Japan - Malaysia  
Malta - Morocco - Singapore - Spain - Sweden - Switzerland - United Kingdom - U.S.A.

<http://www.st.com>