

# NIF5002N

Preferred Device

## Self-Protected FET with Temperature and Current Limit

### 42 V, 2.0 A, Single N-Channel, SOT-223

HDPlus™ devices are an advanced series of power MOSFETs which utilize ON Semiconductors latest MOSFET technology process to achieve the lowest possible on-resistance per silicon area while incorporating smart features. Integrated thermal and current limits work together to provide short circuit protection. The devices feature an integrated Drain-to-Gate Clamp that enables them to withstand high energy in the avalanche mode. The Clamp also provides additional safety margin against unexpected voltage transients. Electrostatic Discharge (ESD) protection is provided by an integrated Gate-to-Source Clamp.

#### Features

- Current Limitation
- Thermal Shutdown with Automatic Restart
- Short Circuit Protection
- $I_{DSS}$  Specified at Elevated Temperature
- Avalanche Energy Specified
- Slew Rate Control for Low Noise Switching
- Overvoltage Clamped Protection

#### Applications

- Lighting
- Solenoids
- Small Motors

#### MAXIMUM RATINGS ( $T_J = 25^\circ\text{C}$ unless otherwise noted)

Rating	Symbol	Value	Unit
Drain-to-Source Voltage Internally Clamped	$V_{DSS}$	42	V
Drain-to-Gate Voltage Internally Clamped ( $R_G = 1.0\text{ M}\Omega$ )	$V_{DGR}$	42	V
Gate-to-Source Voltage	$V_{GS}$	$\pm 14$	V
Continuous Drain Current	$I_D$	Internally Limited	
Power Dissipation	@ $T_A = 25^\circ\text{C}$ (Note 1)	1.1	W
	@ $T_A = 25^\circ\text{C}$ (Note 2)	1.7	
	@ $T_T = 25^\circ\text{C}$ (Note 3)	8.9	
Operating Junction and Storage Temperature	$T_J, T_{stg}$	-55 to 150	$^\circ\text{C}$
Single Pulse Drain-to-Source Avalanche Energy ( $V_{DD} = 32\text{ V}, V_G = 5.0\text{ V}, I_{PK} = 1.0\text{ A}, L = 300\text{ mH}, R_{G(ext)} = 25\ \Omega$ )	$E_{AS}$	150	mJ

#### THERMAL RESISTANCE RATINGS

Rating	Symbol	Value	Unit
Junction-to-Ambient - Steady State (Note 1)	$R_{\theta JA}$	114	$^\circ\text{C/W}$
Junction-to-Ambient - Steady State (Note 2)	$R_{\theta JA}$	72	
Junction-to-Tab - Steady State (Note 3)	$R_{\theta JT}$	14	

1. Surface-mounted onto min pad FR4 PCB, (2 oz. Cu, 0.06" thick).
2. Surface-mounted onto 2" sq. FR4 board (1" sq., 1 oz. Cu, 0.06" thick).
3. Surface-mounted onto min pad FR4 PCB, (2 oz. Cu, 0.06" thick).



ON Semiconductor®

<http://onsemi.com>

$V_{(BR)DSS}$ (Clamped)	$R_{DS(ON)}$ TYP	$I_D$ MAX
42 V	165 m $\Omega$ @ 10 V	2.0 A*

\*Max current limit value is dependent on input condition.

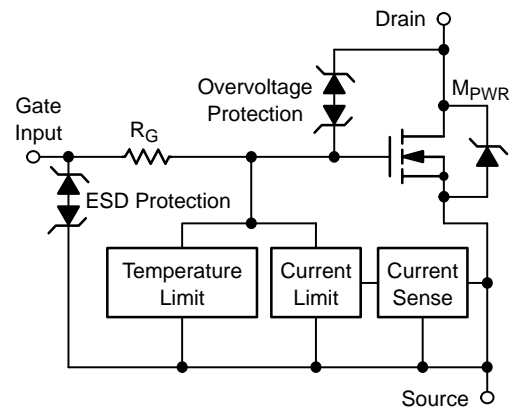

SOT-223  
CASE 318E  
Style 3

#### MARKING DIAGRAM

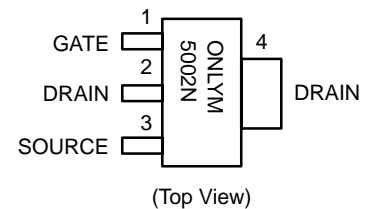

5002N = Specific Device Code  
L = Location Code  
YM = Year, Month

#### ORDERING INFORMATION

Device	Package	Shipping†
NIF5002NT1	SOT-223	1000/Tape & Reel
NIF5002NT3	SOT-223	4000/Tape & Reel

†For information on tape and reel specifications, including part orientation and tape sizes, please refer to our Tape and Reel Packaging Specifications Brochure, BRD8011/D.

Preferred devices are recommended choices for future use and best overall value.

# NIF5002N

## ELECTRICAL CHARACTERISTICS (T<sub>J</sub> = 25°C unless otherwise noted)

Parameter	Symbol	Test Condition	Min	Typ	Max	Unit	
<b>OFF CHARACTERISTICS</b>							
Drain-to-Source Breakdown Voltage (Note 4)	V <sub>(BR)DSS</sub>	V <sub>GS</sub> = 0 V, I <sub>D</sub> = 10 mA	T <sub>J</sub> = 25°C	42	46	55	V
			T <sub>J</sub> = 150°C	40	45	55	
Zero Gate Voltage Drain Current	I <sub>DSS</sub>	V <sub>GS</sub> = 0 V, V <sub>DS</sub> = 32 V	T <sub>J</sub> = 25°C		0.25	4.0	μA
			T <sub>J</sub> = 150°C		1.1	20	
Gate Input Current	I <sub>GSSF</sub>	V <sub>DS</sub> = 0 V, V <sub>GS</sub> = 5.0 V		50	100	μA	

## ON CHARACTERISTICS (Note 4)

Gate Threshold Voltage	V <sub>GS(th)</sub>	V <sub>GS</sub> = V <sub>DS</sub> , I <sub>D</sub> = 150 μA	1.3	1.8	2.2	V	
Gate Threshold Temperature Coefficient	V <sub>GS(th)</sub> /T <sub>J</sub>			4.0	6.0	-mV/°C	
Static Drain-to-Source On-Resistance	R <sub>DS(on)</sub>	V <sub>GS</sub> = 10 V, I <sub>D</sub> = 1.7 A	T <sub>J</sub> = 25°C		165	200	mΩ
			T <sub>J</sub> = 150°C		305	400	
		V <sub>GS</sub> = 5.0 V, I <sub>D</sub> = 1.7 A	T <sub>J</sub> = 25°C		195	230	
			T <sub>J</sub> = 150°C		360	460	
		V <sub>GS</sub> = 5.0 V, I <sub>D</sub> = 0.5 A	T <sub>J</sub> = 25°C		190	230	
			T <sub>J</sub> = 150°C		350	460	
Source-Drain Forward On Voltage	V <sub>SD</sub>	V <sub>GS</sub> = 0 V, I <sub>S</sub> = 7.0 A		1.0		V	

## SWITCHING CHARACTERISTICS

Turn-on Time	t <sub>d(on)</sub>	V <sub>GS</sub> = 10 V, V <sub>DD</sub> = 12 V, I <sub>D</sub> = 2.5 A, R <sub>L</sub> = 4.7 Ω, (10% V <sub>in</sub> to 90% I <sub>D</sub> )		20	30	μs
Turn-off Time	t <sub>d(off)</sub>			65	100	
Slew Rate On	dV <sub>DS</sub> /dt <sub>on</sub>	R <sub>L</sub> = 4.7 Ω, V <sub>in</sub> = 0 to 10 V, V <sub>DD</sub> = 12 V, 70% to 50%		1.2		V/μs
Slew-Rate Off	dV <sub>DS</sub> /dt <sub>off</sub>	R <sub>L</sub> = 4.7 Ω, V <sub>in</sub> = 0 to 10 V, V <sub>DD</sub> = 12 V, 50% to 70%		0.5		

## SELF PROTECTION CHARACTERISTICS (T<sub>J</sub> = 25°C unless otherwise noted) (Note 5)

Current Limit	I <sub>LIM</sub>	V <sub>DS</sub> = 10 V, V <sub>GS</sub> = 5.0 V	T <sub>J</sub> = 25°C	3.1	4.7	6.3	A
			T <sub>J</sub> = 150°C	2.0	3.2	4.3	
		V <sub>DS</sub> = 10 V, V <sub>GS</sub> = 10 V	T <sub>J</sub> = 25°C	3.8	5.7	7.6	
			T <sub>J</sub> = 150°C	2.8	4.3	5.7	
Temperature Limit (Turn-off)	T <sub>LIM(off)</sub>	V <sub>GS</sub> = 5.0 V	150	175	200	°C	
Temperature Limit (Circuit Reset)	T <sub>LIM(on)</sub>	V <sub>GS</sub> = 5.0 V	135	160	185		
Temperature Limit (Turn-off)	T <sub>LIM(off)</sub>	V <sub>GS</sub> = 10 V	150	165	185		
Temperature Limit (Circuit Reset)	T <sub>LIM(on)</sub>	V <sub>GS</sub> = 10 V	135	150	170		

## ESD ELECTRICAL CHARACTERISTICS (T<sub>J</sub> = 25°C unless otherwise noted)

Electro-Static Discharge Capability	ESD	Human Body Model (HBM)	4000			V
		Machine Model (MM)	400			

4. Pulse Test: Pulse Width ≤ 300 μs, Duty Cycle ≤ 2%.

5. Fault conditions are viewed as beyond the normal operating range of the part.

TYPICAL PERFORMANCE CURVES

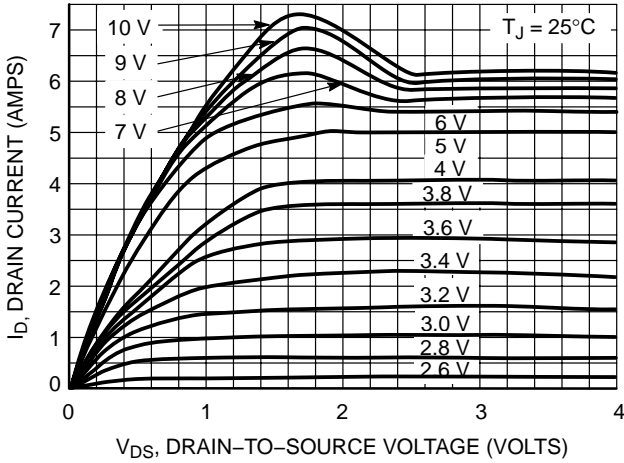

Figure 1. On-Region Characteristics

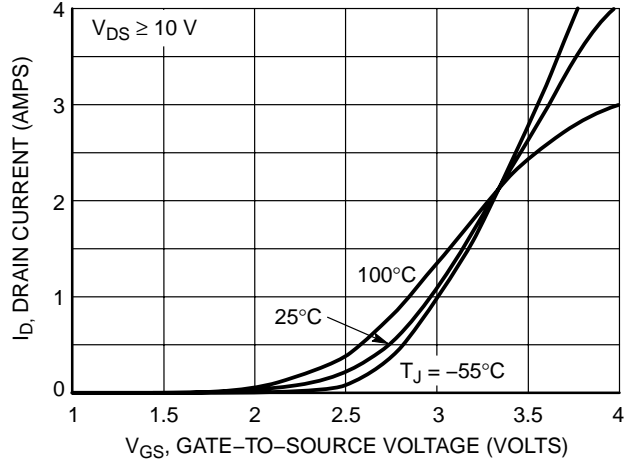

Figure 2. Transfer Characteristics

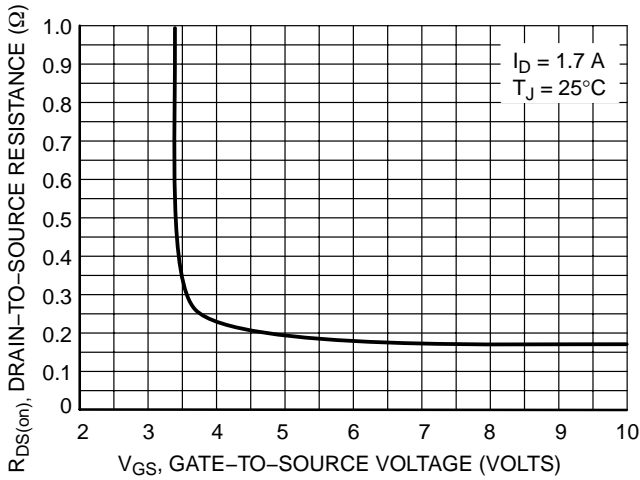

Figure 3. On-Resistance vs. Gate-to-Source Voltage

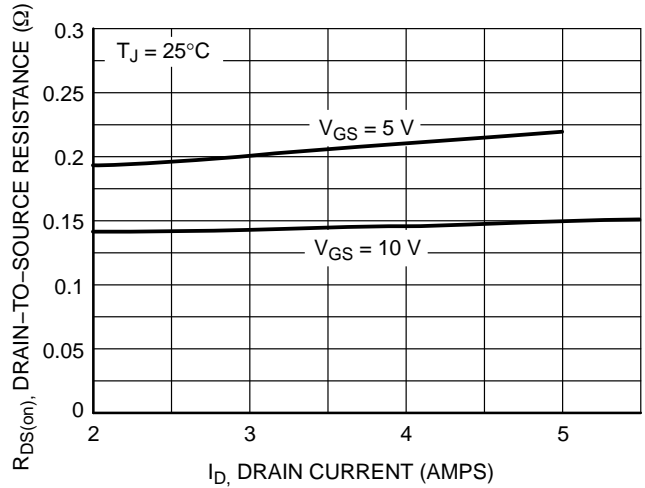

Figure 4. On-Resistance vs. Drain Current and Gate Voltage

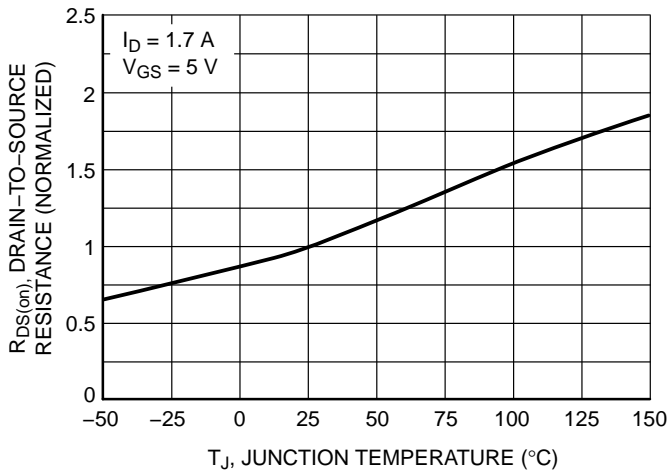

Figure 5. On-Resistance Variation with Temperature

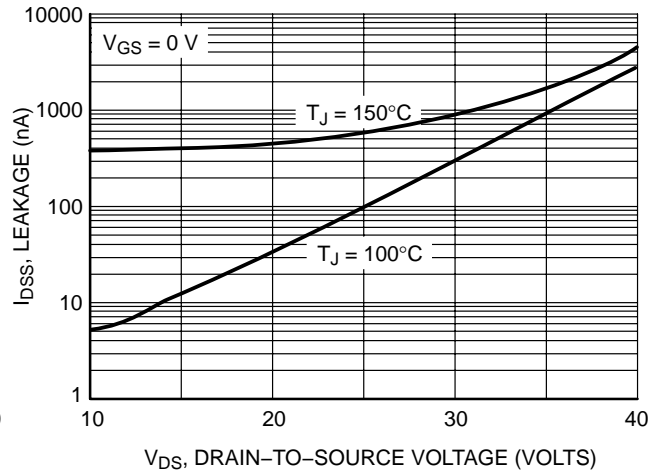

Figure 6. Drain-to-Source Leakage Current vs. Voltage

TYPICAL PERFORMANCE CURVES

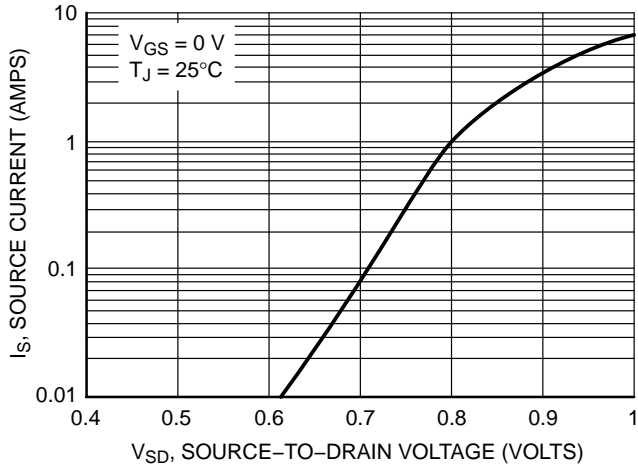

Figure 7. Diode Forward Voltage vs. Current

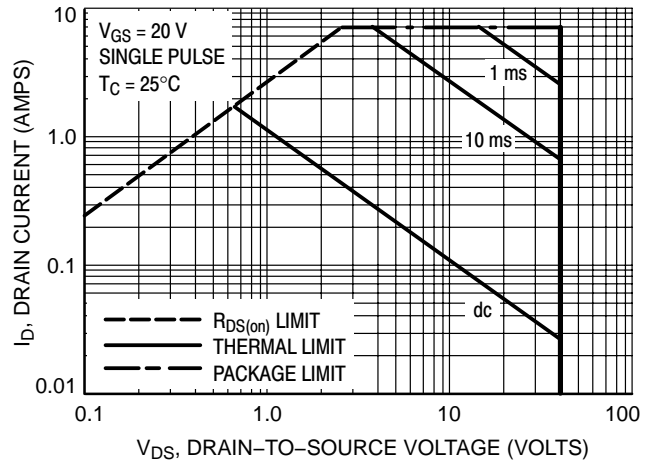

Figure 8. Maximum Rated Forward Biased Safe Operating Area

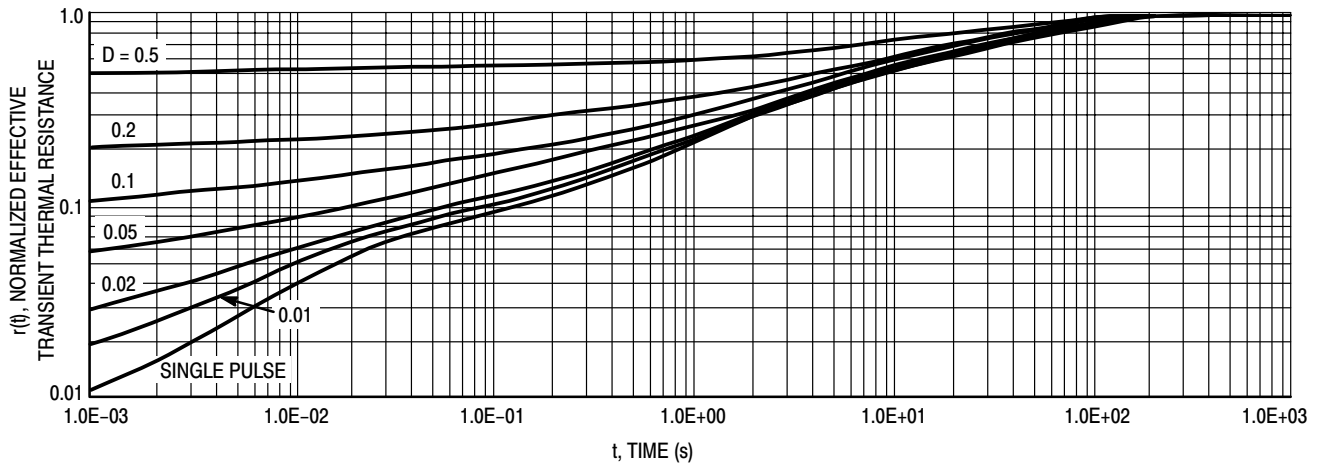
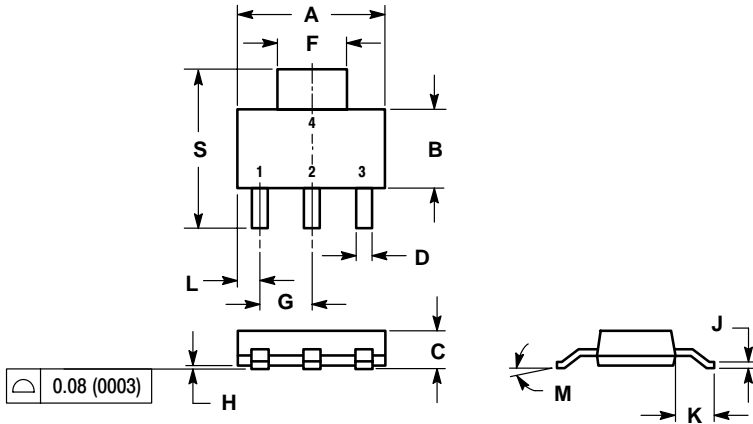

Figure 9. Thermal Response

# NIF5002N

## PACKAGE DIMENSIONS

SOT-223  
CASE 318E-04  
ISSUE K



NOTES:  
1. DIMENSIONING AND TOLERANCING PER ANSI Y14.5M, 1982.  
2. CONTROLLING DIMENSION: INCH.

DIM	INCHES		MILLIMETERS	
	MIN	MAX	MIN	MAX
A	0.249	0.263	6.30	6.70
B	0.130	0.145	3.30	3.70
C	0.060	0.068	1.50	1.75
D	0.024	0.035	0.60	0.89
F	0.115	0.126	2.90	3.20
G	0.087	0.094	2.20	2.40
H	0.0008	0.0040	0.020	0.100
J	0.009	0.014	0.24	0.35
K	0.060	0.078	1.50	2.00
L	0.033	0.041	0.85	1.05
M	0°	10°	0°	10°
S	0.264	0.287	6.70	7.30

STYLE 3:  
PIN 1. GATE  
2. DRAIN  
3. SOURCE  
4. DRAIN

HDPlus is registered trademark of Semiconductor Components Industries, LLC (SCILLC).

**ON Semiconductor** and  are registered trademarks of Semiconductor Components Industries, LLC (SCILLC). SCILLC reserves the right to make changes without further notice to any products herein. SCILLC makes no warranty, representation or guarantee regarding the suitability of its products for any particular purpose, nor does SCILLC assume any liability arising out of the application or use of any product or circuit, and specifically disclaims any and all liability, including without limitation special, consequential or incidental damages. "Typical" parameters which may be provided in SCILLC data sheets and/or specifications can and do vary in different applications and actual performance may vary over time. All operating parameters, including "Typicals" must be validated for each customer application by customer's technical experts. SCILLC does not convey any license under its patent rights nor the rights of others. SCILLC products are not designed, intended, or authorized for use as components in systems intended for surgical implant into the body, or other applications intended to support or sustain life, or for any other application in which the failure of the SCILLC product could create a situation where personal injury or death may occur. Should Buyer purchase or use SCILLC products for any such unintended or unauthorized application, Buyer shall indemnify and hold SCILLC and its officers, employees, subsidiaries, affiliates, and distributors harmless against all claims, costs, damages, and expenses, and reasonable attorney fees arising out of, directly or indirectly, any claim of personal injury or death associated with such unintended or unauthorized use, even if such claim alleges that SCILLC was negligent regarding the design or manufacture of the part. SCILLC is an Equal Opportunity/Affirmative Action Employer. This literature is subject to all applicable copyright laws and is not for resale in any manner.

## PUBLICATION ORDERING INFORMATION

### LITERATURE FULFILLMENT:

Literature Distribution Center for ON Semiconductor  
P.O. Box 5163, Denver, Colorado 80217 USA

**Phone:** 303-675-2175 or 800-344-3860 Toll Free USA/Canada

**Fax:** 303-675-2176 or 800-344-3867 Toll Free USA/Canada

**Email:** [orderlit@onsemi.com](mailto:orderlit@onsemi.com)

**N. American Technical Support:** 800-282-9855 Toll Free  
USA/Canada

**Japan:** ON Semiconductor, Japan Customer Focus Center  
2-9-1 Kamimeguro, Meguro-ku, Tokyo, Japan 153-0051  
**Phone:** 81-3-5773-3850

**ON Semiconductor Website:** <http://onsemi.com>

**Order Literature:** <http://www.onsemi.com/litorder>

For additional information, please contact your  
local Sales Representative.