

LT202A

GaAs Hall IC for Fan Motor

■ Features

- Increasing the efficiency of motor rotation due to cutting the electric current which doesn't contributing to rotation
- Combining a GaAs Hall device and a driver IC in a compact 8-pin SOP package
- Operation in low magnetic flux density (10mT) due to applied high sensitive Hall device
- Built-in protection circuit, alarm output and automatic restart circuit

■ Applications

- Brushless fan motors
 1. Cooling fan motors for personal computers, word processors, etc.
 2. Directly cooling fan motors for cooling fin, PCB, etc.
 3. Fan motors for air circulation of temperature sensor in air conditioner

■ Outline Dimensions

(Unit : mm)

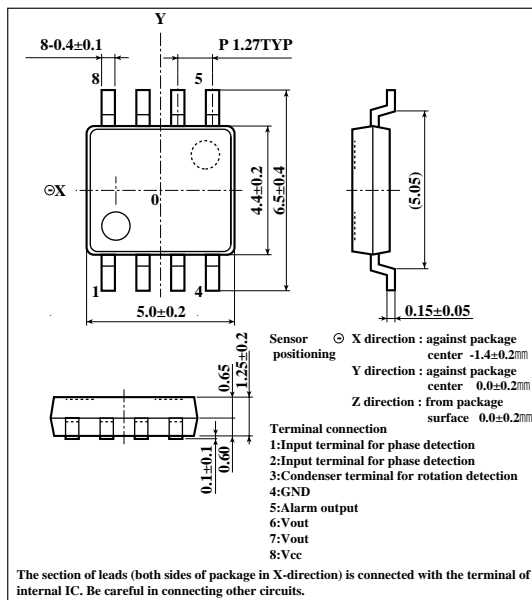

■ Absolute Maximum Ratings

(T_a=25°C)

Parameter	Symbol	Conditions	Rating	Unit
Supply voltage	V _{CC}		30	V
Output voltage	V _O		55	V
Output current (peak)	I _{OMAX}	V _{CC} =12V	750	mA
		V _{CC} =24V	450	mA
Output current (continuous)	I _O	V _{CC} =12V	250	mA
		V _{CC} =24V	150	mA
Coil input voltage	V _{IN}		-0.2 to 0.2	V
Alarm output sink current	I _{ISINK}		5	mA
Power dissipation	P _D		400	mW
Operating temperature	T _{opr}		-20 to +80	°C
Storage temperature	T _{stg}		-55 to +150	°C
Soldering temperature*1	T _{sol}		260	°C

*1 Soldering time : within 10 seconds

As for dimensions of tape-packaged products, refer to page 44 .

■ Electrical Characteristics

(T_a=25°C)

Parameter	Symbol	Conditions	MIN.	TYP.	MAX.	Unit
Output saturation voltage	V _{OUT}	I _O =250mA, V _{CC} =12V	-	-	1.5	V
Output cut-off current	I _{OC}	V _O =55V	-	-	30	μA
Operating supply voltage	V _{CC}	*	8	-	28	V
Supply current	I _{CC}	At no-load	-	-	13	mA
Operating magnetic flux density	B ₁		-10	-	-	mT
	B ₂		-	-	10	mT
Coil input sensitivity	V _{IN}		15	-	-	mV
Alarm output saturation voltage	V _{SAT}	I _{ISINK} =4mA	-	-	0.5	V
Alarm output leakage current	I _{LEAK}	V=28V	-	-	15	μA

(Note) Unspecified condition is V_{CC}=24V.* In case of oscillating from power supply due to wiring, connect a condenser between 8-pin (V_{CC}) and 4-pin (GND).

SHARP

In the absence of confirmation by device specification sheets, SHARP takes no responsibility for any defects that may occur in equipment using any SHARP devices shown in catalogs, data books, etc. Contact SHARP in order to obtain the latest device specification sheets before using any SHARP device.

Block Diagram and Timing Chart

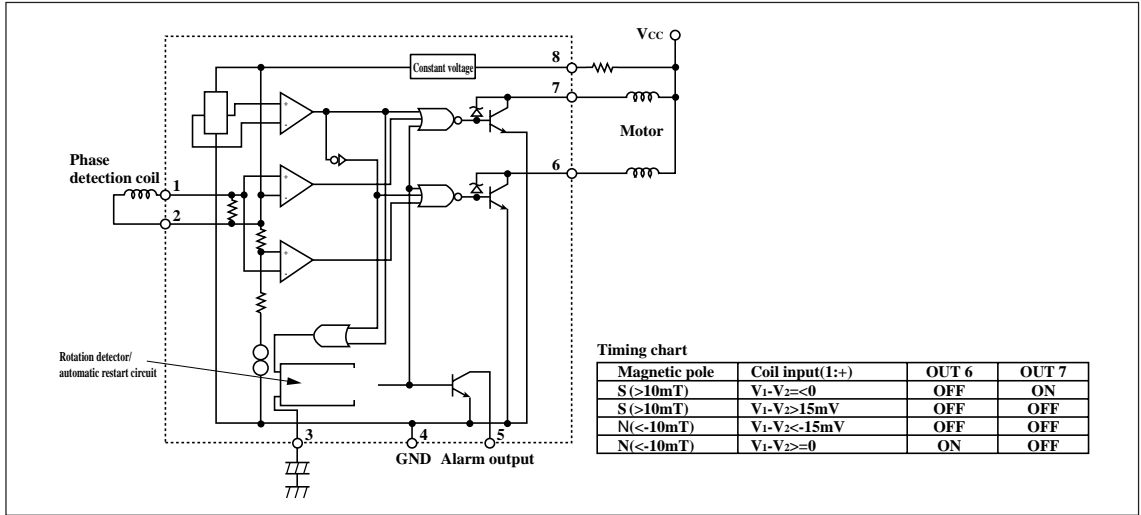

Fig. 1 Output Saturation Voltage vs. Ambient Temperature

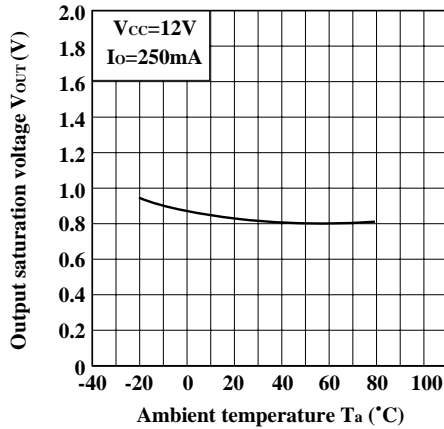

Fig. 2 Output Saturation Voltage vs. Input Current (Continuous)

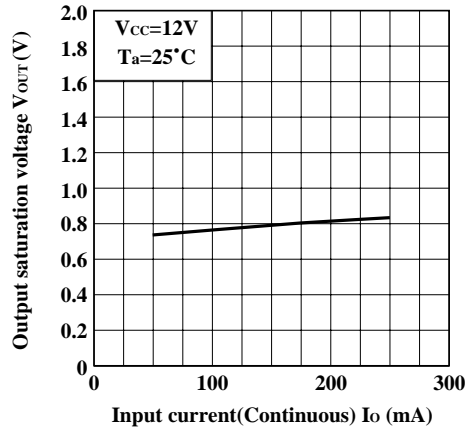

Fig. 3 Supply Current vs. Ambient Temperature

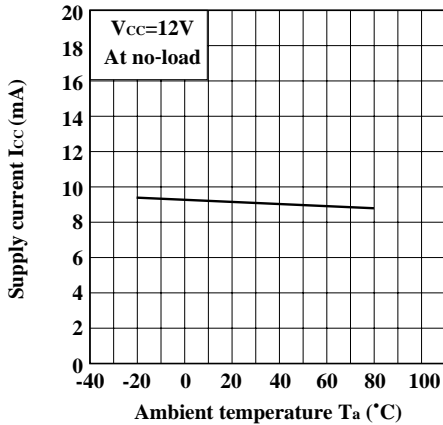

Fig. 4 Supply Current vs. Supply Voltage

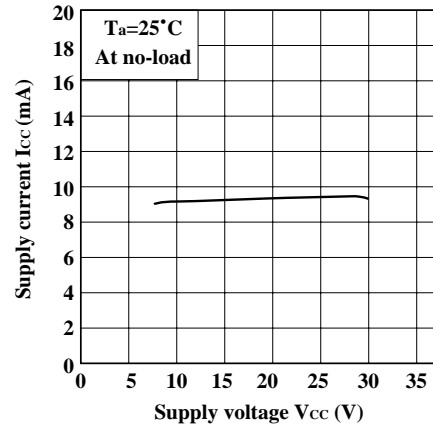

Fig. 5 Coil Input Sensitivity vs. Ambient Temperature

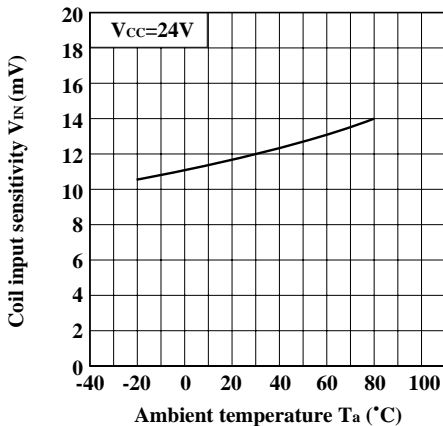

Fig. 6 Operating Magnetic Flux Density vs. Ambient Temperature

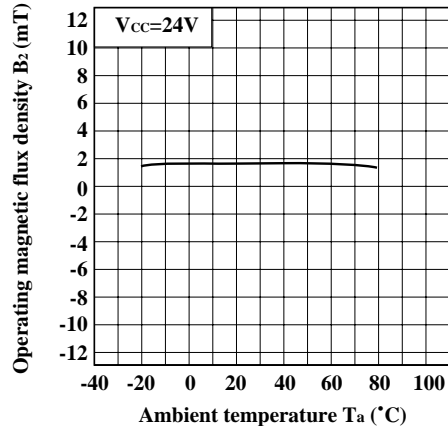

Fig. 7 Alarm Output Saturation Voltage vs. Ambient Temperature

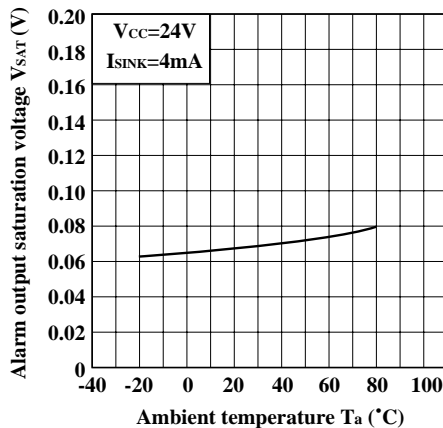

Fig. 8 Alarm Output Saturation Voltage vs. Alarm Output Sink Current

