

SHINDENGEN

Schottky Rectifiers (SBD)

Dual

D10SC6M

60V 10A

FEATURES

- Tj150
- P_{RRSM} avalanche guaranteed
- Fully Isolated Molding

APPLICATION

- Switching power supply
- DC/DC converter
- Home Appliances, Office Equipment
- Telecommunication

OUTLINE DIMENSIONS

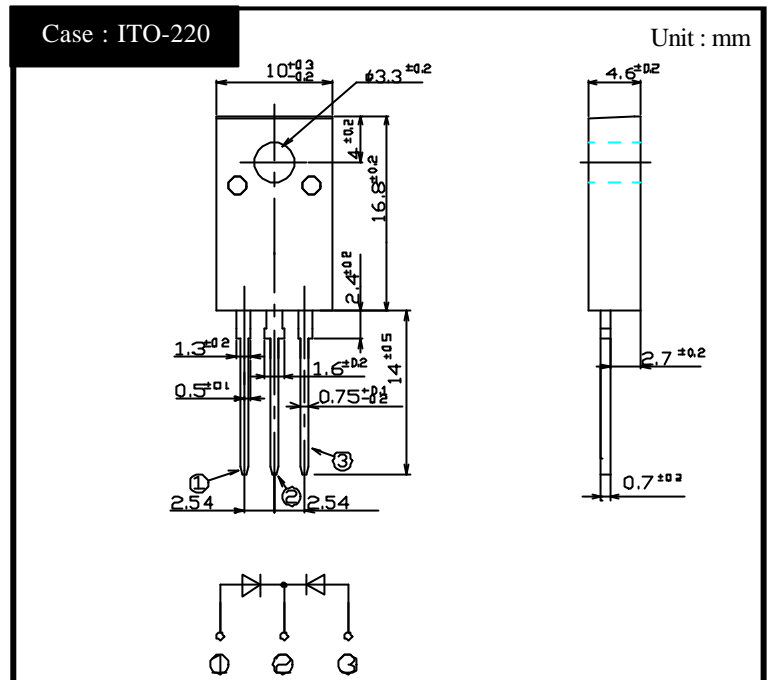

RATINGS

Absolute Maximum Ratings (If not specified Tc=25)

Item	Symbol	Conditions	Ratings	Unit
Storage Temperature	T _{stg}		-40 ~ 150	
Operating Junction Temperature	T _j		150	
Maximum Reverse Voltage	V _{RM}		60	V
Repetitive Peak Surge Reverse Voltage	V _{RRSM}	Pulse width 0.5ms, duty 1/40	65	V
Average Rectified Forward Current	I _o	50Hz sine wave, R-load, Rating for each diode I _o /2, T _c =120	10	A
Peak Surge Forward Current	I _{FSM}	50Hz sine wave, Non-repetitive 1 cycle peak value, T _j =125	100	A
Repetitive Peak Surge Reverse Power	P _{RRSM}	Pulse width 10 μs, Rating of per diode, T _j = 25	330	W
Dielectric Strength	V _{dis}	Terminals to case, AC 1 minute	1.5	kV
Mounting Torque	TOR	(Recommended torque :0.3N·m)	0.5	N·m

Electrical Characteristics (If not specified Tc=25)

Item	Symbol	Conditions	Ratings	Unit
Forward Voltage	V _F	I _F =5A, Pulse measurement, Rating of per diode	Max.0.58	V
Reverse Current	I _R	V _R =V _{RM} , Pulse measurement, Rating of per diode	Max.4.5	mA
Junction Capacitance	C _j	f=1MHz, V _R =10V, Rating of per diode	Typ.200	pF
Thermal Resistance	j-c	junction to case	Max.3.3	/W
	c-f	case to heatsink, Mounting torque=0.5N·m	Max.1.5	
	j-f	junction to heatsink, Mounting torque=0.5N·m	Max.4.8	

D10SC6M Forward Voltage

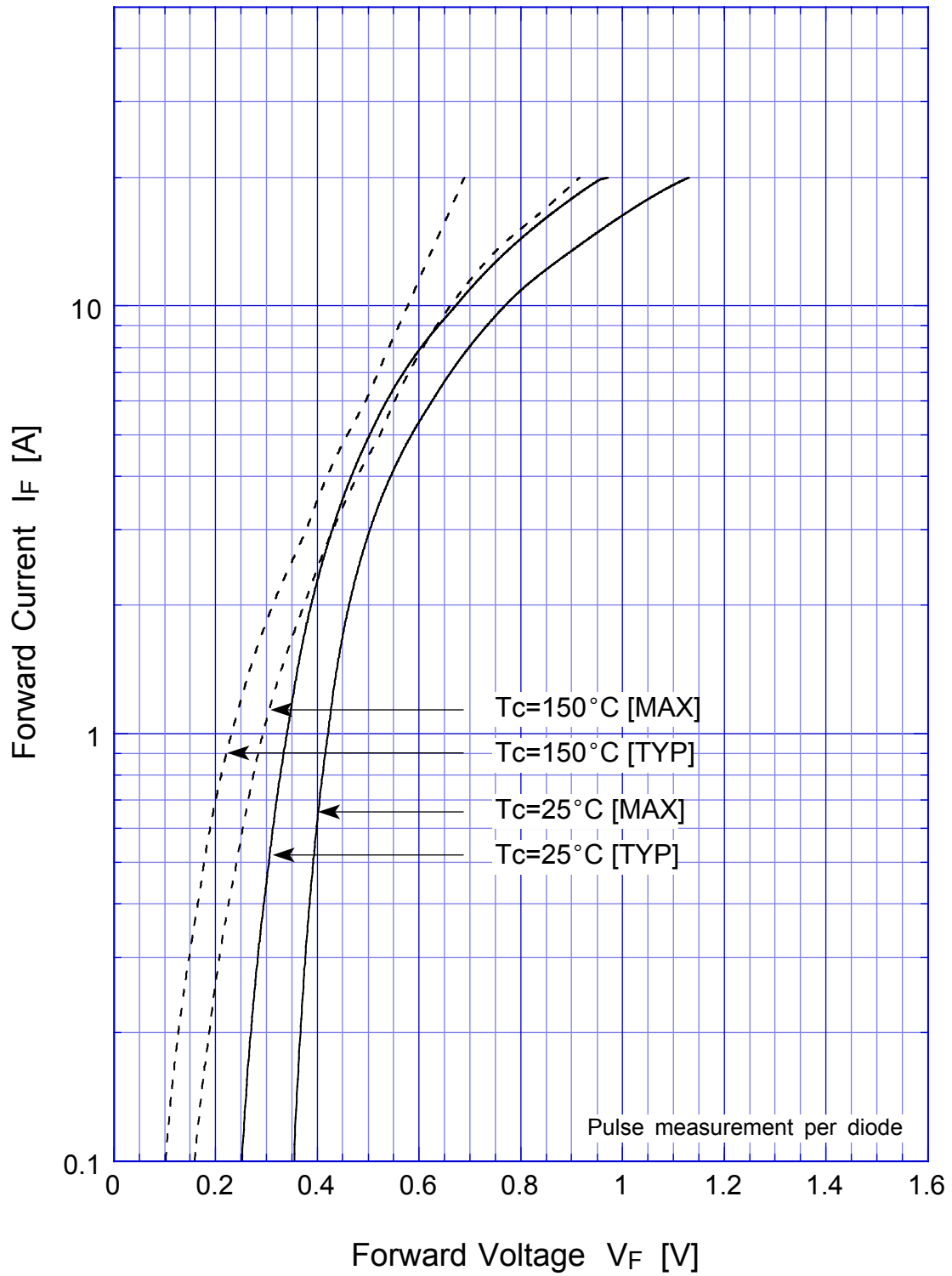

D10SC6M

Junction Capacitance

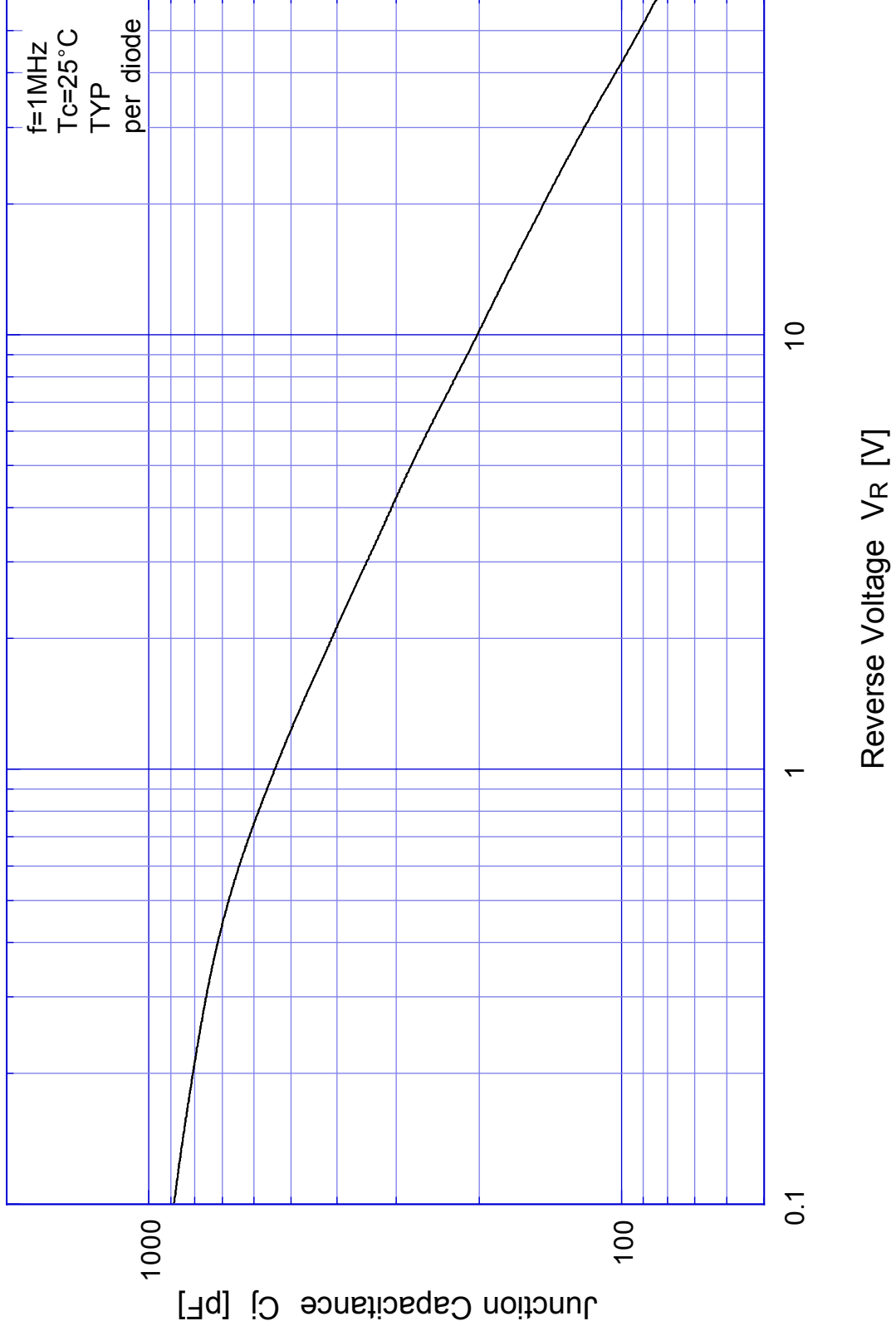

D10SC6M Reverse Current

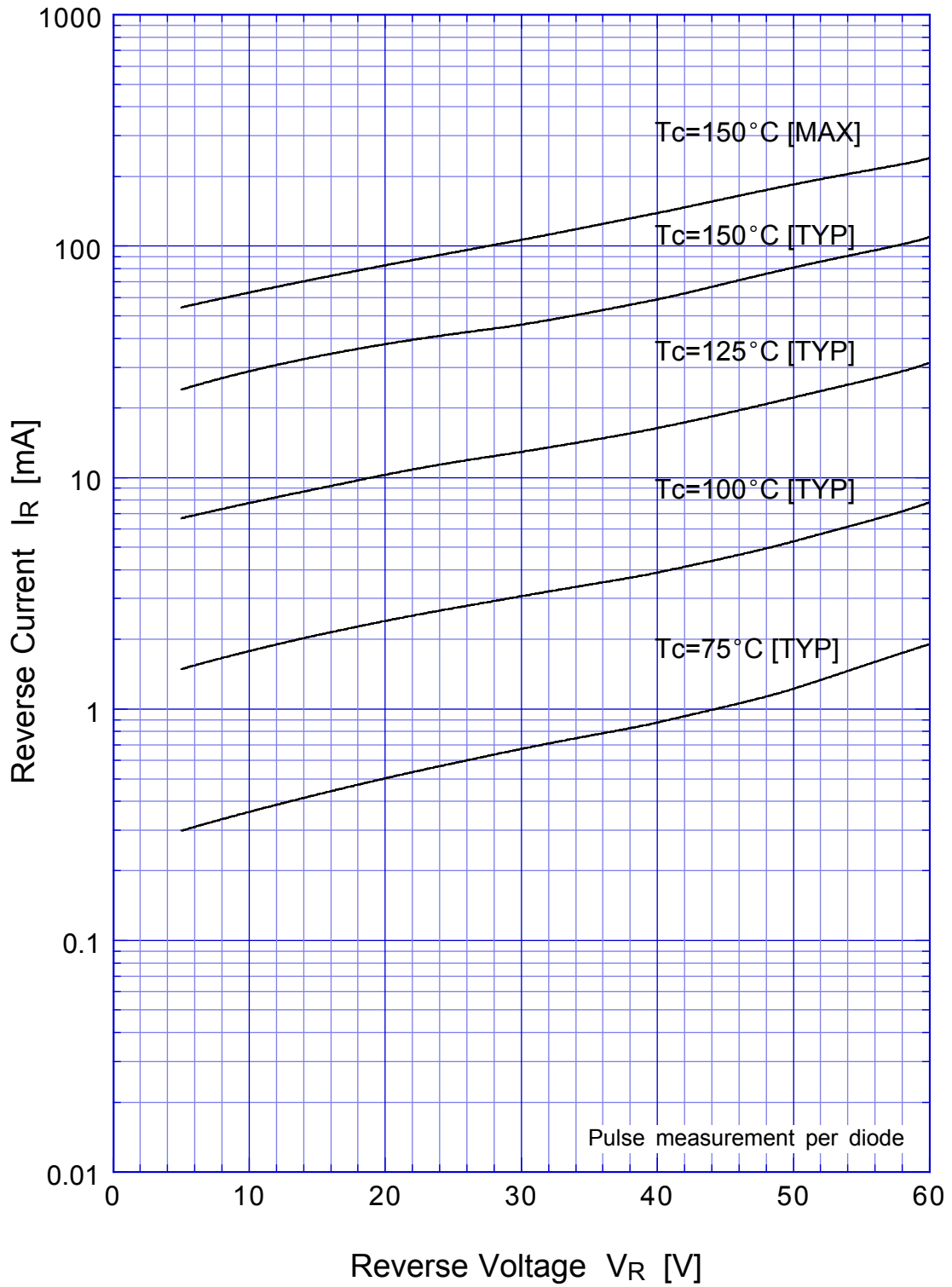

D10SC6M Reverse Power Dissipation

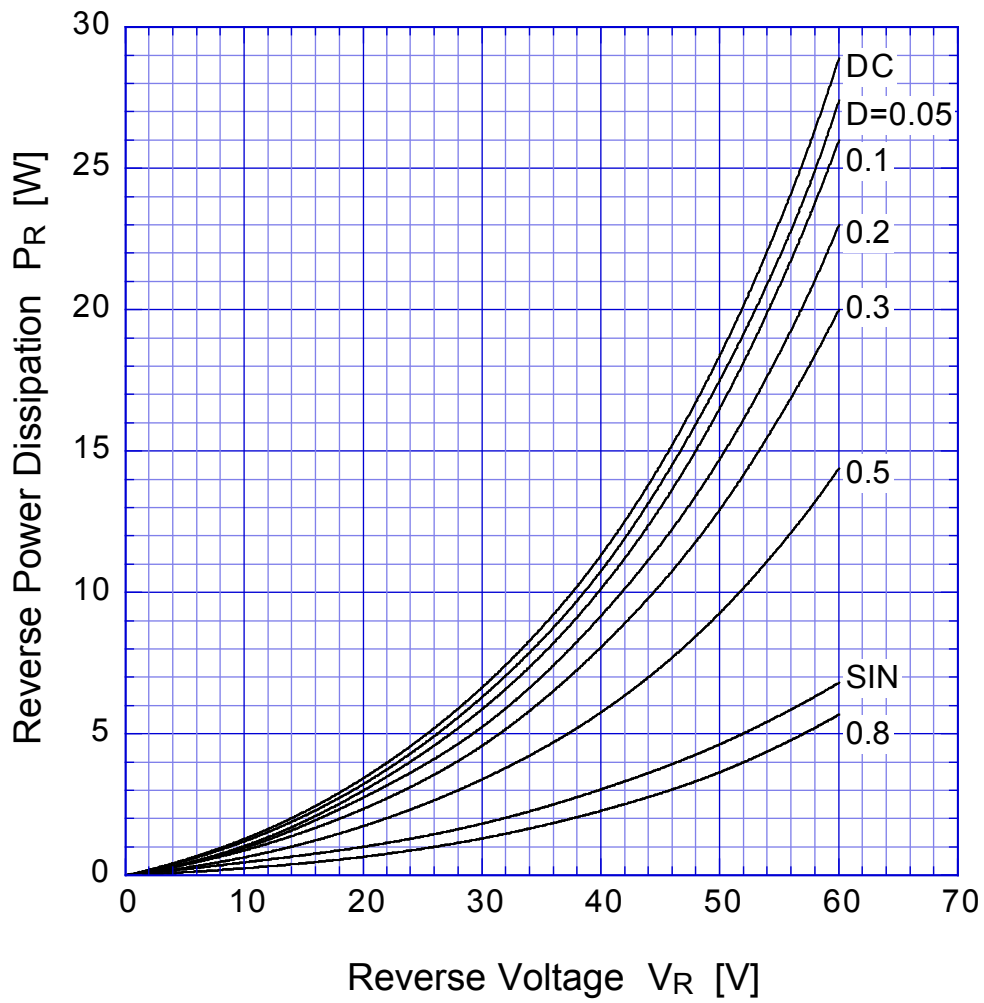

$T_j = 150^\circ\text{C}$

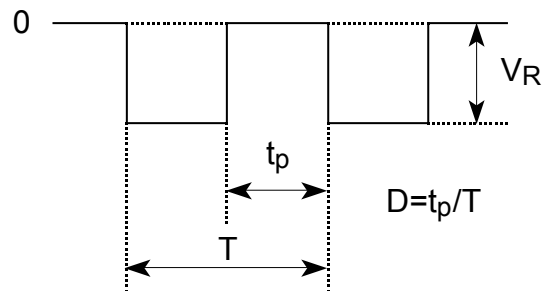

D10SC6M Forward Power Dissipation

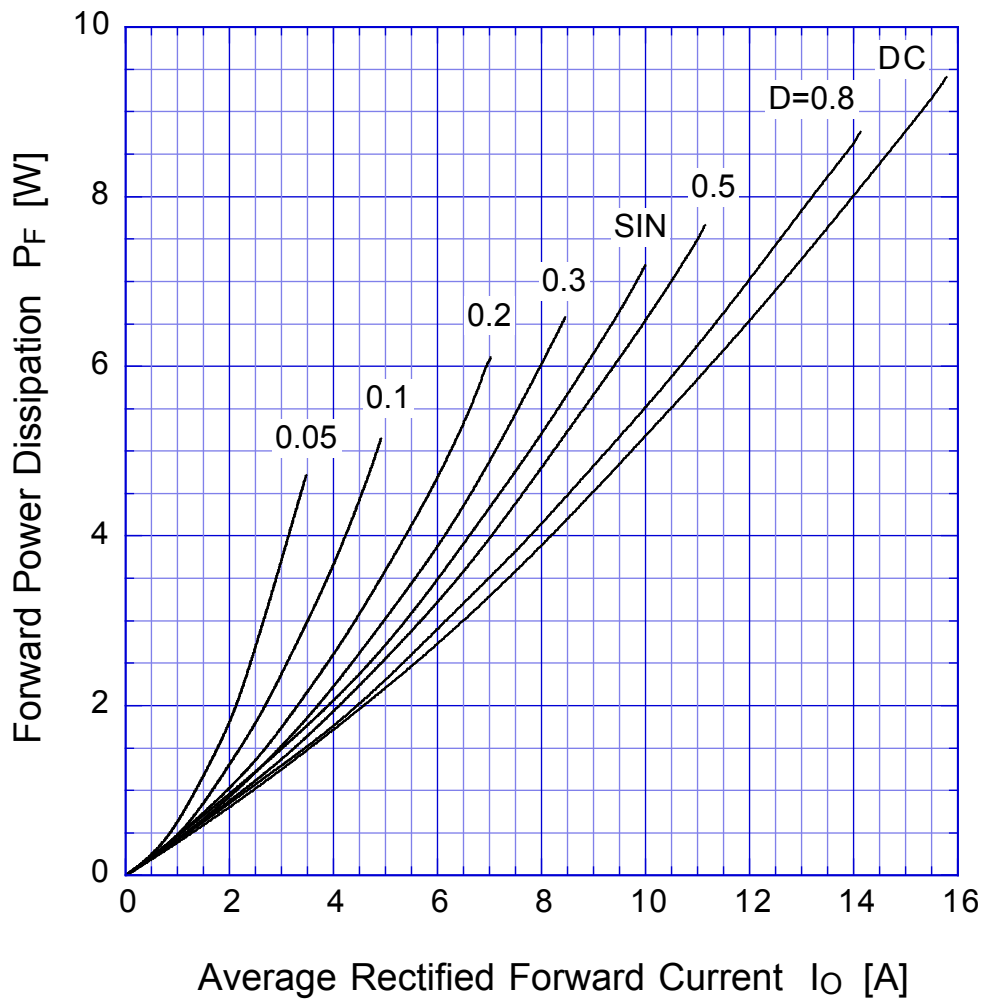

$T_j = 150^\circ\text{C}$

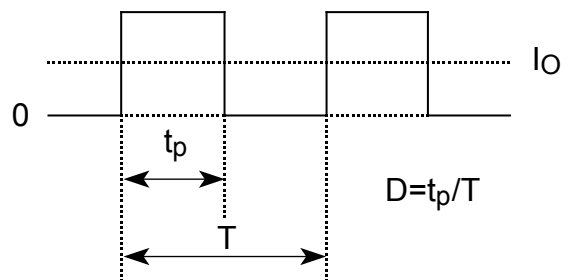

D10SC6M

Derating Curve

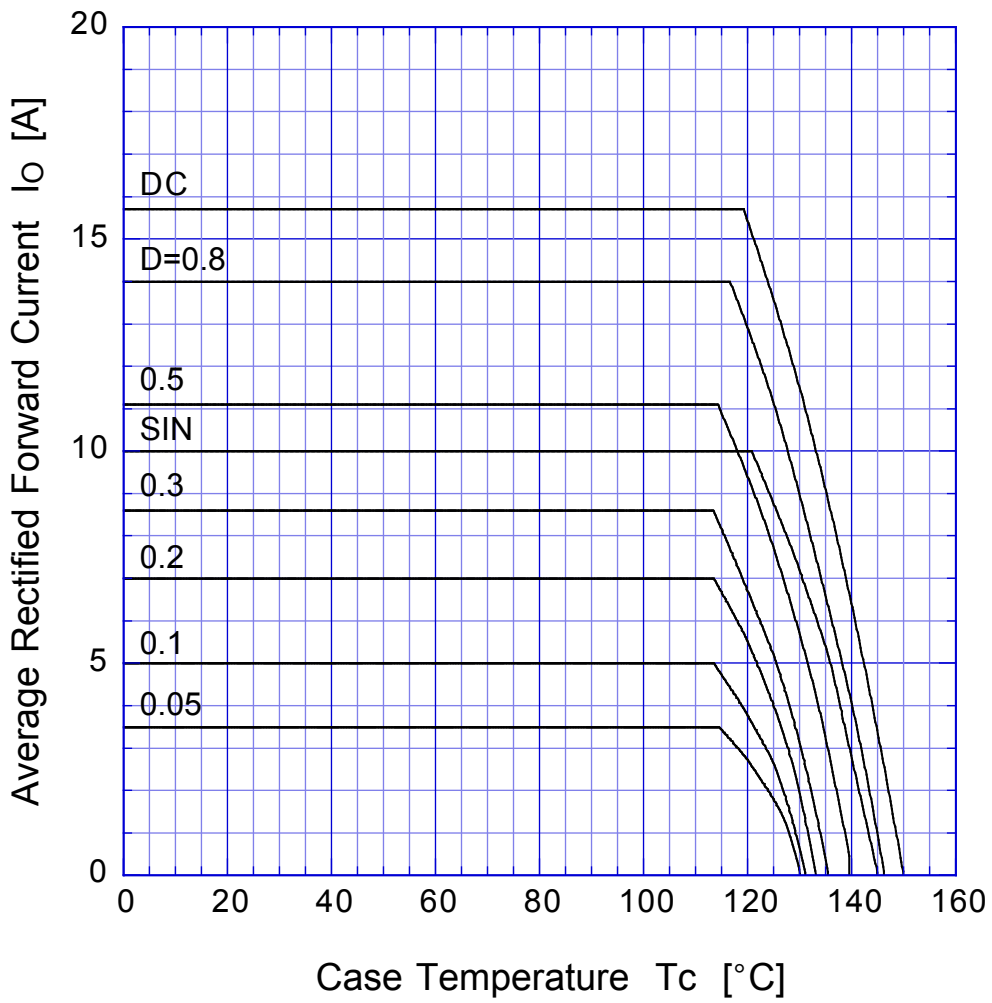

$V_R = 30V$



D10SC6M

Derating Curve

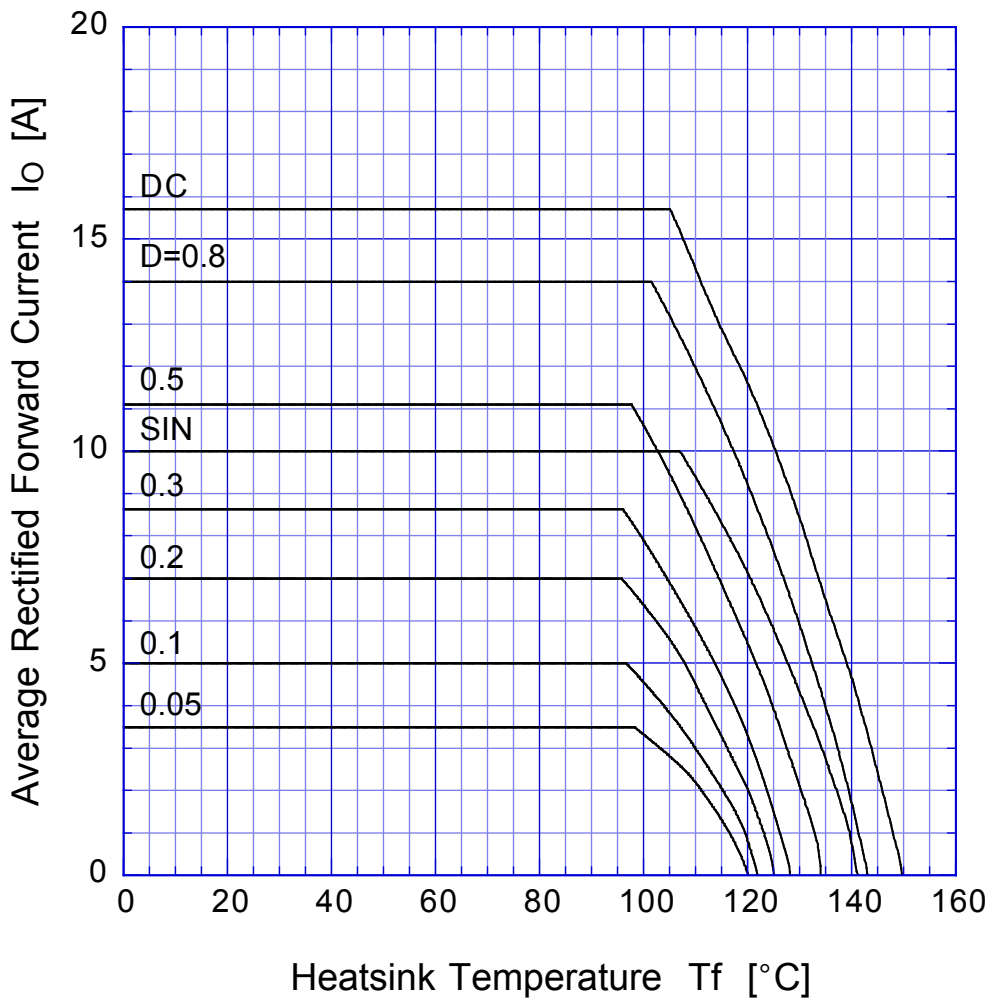

$V_R = 30V$

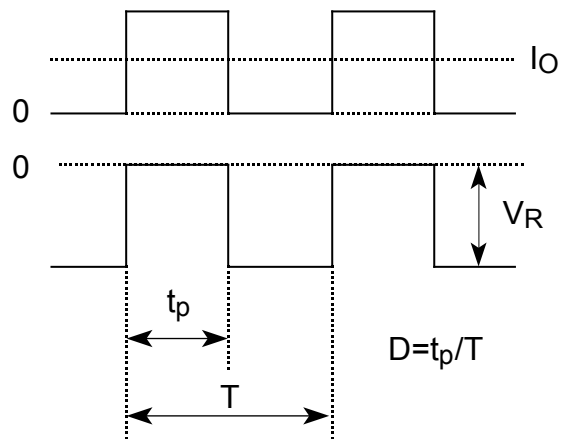

D10SC6M Peak Surge Forward Capability

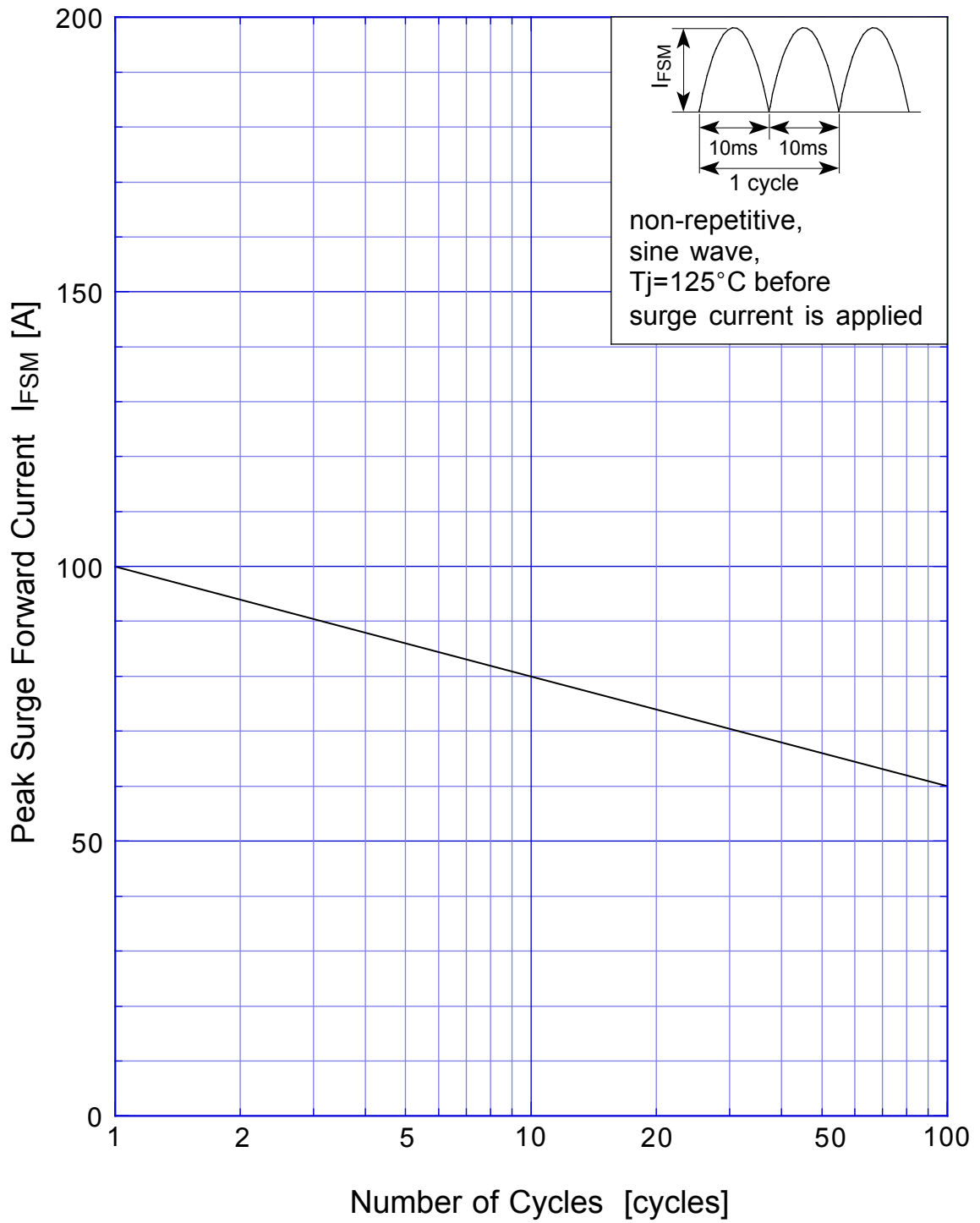

SBD Repetitive Surge Reverse Power Derating Curve

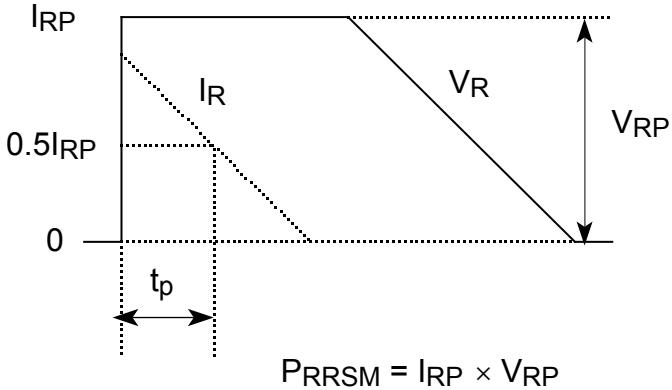
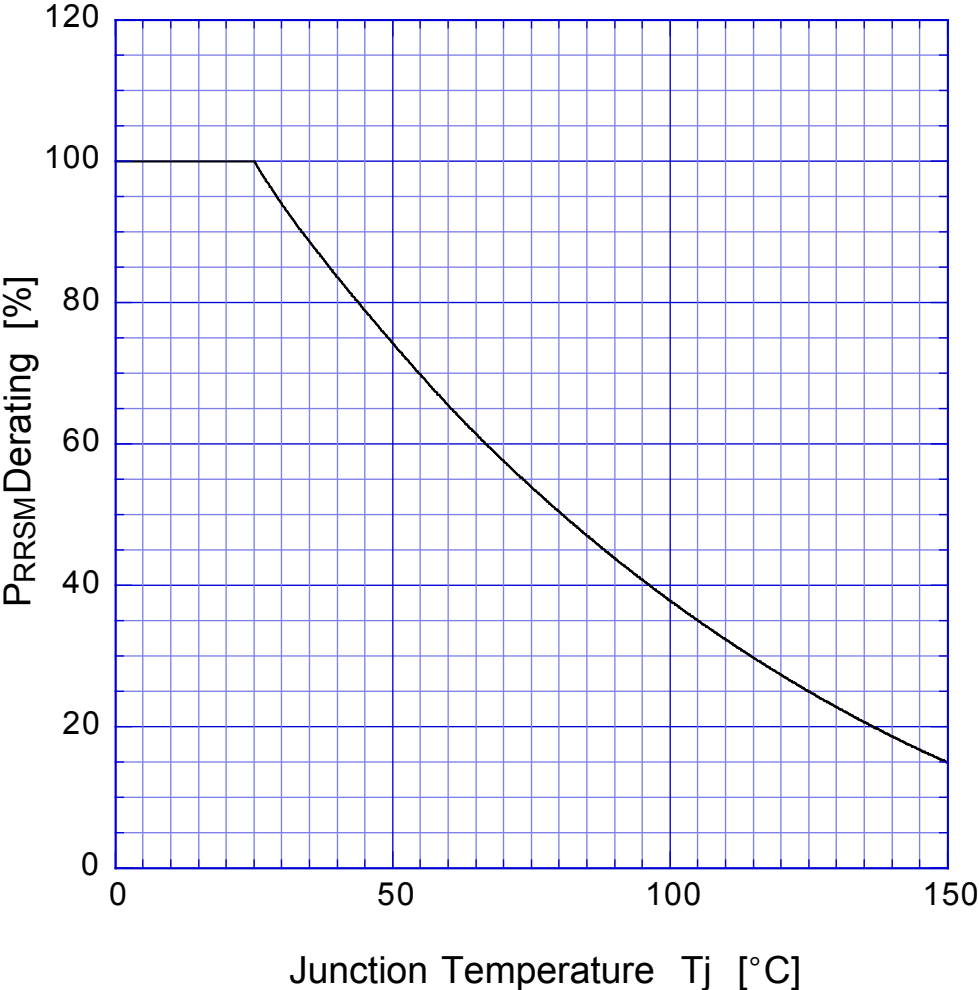

SBD

Repetitive Surge Reverse Power Capability

