

**μ A9665 • μ A9666
 μ A9667 • μ A9668**
**High Current/Voltage
 Darlington Drivers**

Linear Division Interface Products

Description

The μ A9665, μ A9666, μ A9667, and μ A9668 are comprised of seven high voltage, high current NPN Darlington transistor pairs. All units feature common emitter, open collector outputs. To maximize their effectiveness, these units contain suppression diodes for inductive loads and appropriate emitter base resistors for leakage.

The μ A9665 is a general purpose array which may be used with DTL, TTL, PMOS, CMOS, etc. Input current limiting is done by connecting an appropriate discrete resistor to each input.

The μ A9666 version does away with the need for any external discrete resistors, since each unit has a resistor and a Zener diode in series with the input. The μ A9666 was specifically designed for direct interface from PMOS logic (operating at supply voltages from 14 V to 25 V) to solenoids or relays.

The μ A9667 has a series base resistor to each Darlington pair, thus allowing operation directly with TTL or CMOS operating at supply voltages of 5.0 V.

The μ A9668 has an appropriate input resistor to allow direct operation from CMOS or PMOS outputs operating from supply voltages of 6.0 V to 15 V.

The μ A9665, μ A9666, μ A9667, and μ A9668 offer solutions to a great many interface needs, including solenoids, relays, lamps, small motors, and LEDs. Applications requiring sink currents beyond the capability of a single output may be accommodated by paralleling the outputs.

- Seven High Gain Darlington Pairs
- High Output Voltage ($V_{CE} = 50$ V)
- High Output Current ($I_C = 350$ mA)
- DTL, TTL, PMOS, CMOS Compatible
- Suppression Diodes For Inductive Loads
- 2 Watt Molded DIP On Copper Lead Frame
- Extended Temperature Range

**Connection Diagram
 16-Lead DIP
 (Top View)**

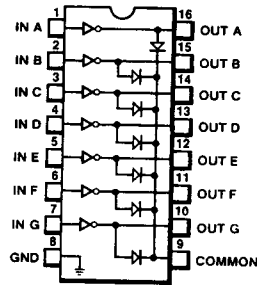

Order Information

Device Code	Package Code	Package Description
μ A9665DC	6B	Ceramic DIP
μ A9665PC	9B	Molded DIP
μ A9666DM	6B	Ceramic DIP
μ A9666DC	6B	Ceramic DIP
μ A9666PC	9B	Molded DIP
μ A9667DM	6B	Ceramic DIP
μ A9667DC	6B	Ceramic DIP
μ A9667PC	9B	Molded DIP
μ A9668DM	6B	Ceramic DIP
μ A9668DC	6B	Ceramic DIP
μ A9668PC	9B	Molded DIP

Absolute Maximum Ratings

Storage Temperature Range	
Ceramic DIP	-65°C to +175°C
Molded DIP	-65°C to +150°C
Operating Temperature Range	
Extended (μ A9666/7/8M)	-55°C to +125°C
Commercial (μ A9665/6/7/8C)	0°C to +70°C
Lead Temperature	
Ceramic DIP (soldering, 60 s)	300°C
Molded DIP (soldering, 10 s)	265°C
Internal Power Dissipation ^{1, 2}	
16L-Ceramic DIP	1.50 W
16L-Molded DIP	1.04 W
Input Voltage	30 V
Output Voltage	55 V
Emitter-Base Voltage	6.0 V
Continuous Collector Current	500 mA
Continuous Base Current	25 mA

Notes

- $T_{J \text{ Max}}$ = 175°C for the Ceramic DIP, and 150°C for the Molded DIP.
- Ratings apply to ambient temperature at 25°C. Above this temperature, derate the 16L-Ceramic DIP at 10 mW/°C, and the 16L-Molded DIP at 8.3 mW/°C.
- Under normal operating conditions, these units will sustain 350 mA per output with $V_{CE(Sat)}$ = 1.6 V at 70°C with a pulse width of 20 ms and a duty cycle of 30%.

Equivalent Circuits

μ A9665

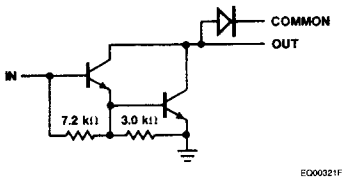

μ A9667

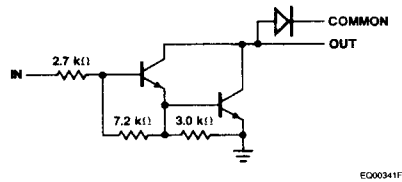

μ A9666

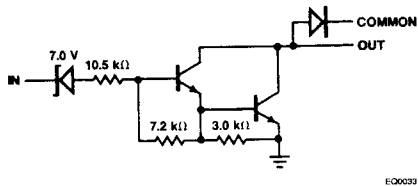

μ A9668

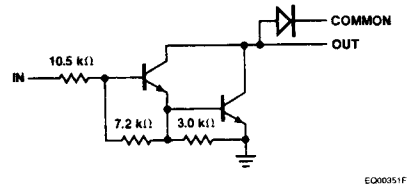

μA9665/6/7/8

Electrical Characteristics $T_A = 25^\circ\text{C}$, unless otherwise specified.

Symbol	Characteristic	Conditions ¹	Test Figure	Min	Typ	Max	Unit
I_{CEX}	Output Leakage Current	$T_A = 70^\circ\text{C}$ for Commercial $V_{CE} = 50\text{ V}$	1a			100	μA
		$V_{CE} = 50\text{ V}$, $V_I = 6.0\text{ V}$	μA9666	1b		500	
		$V_{CE} = 50\text{ V}$, $V_I = 1.0\text{ V}$	μA9668	1b		500	
$V_{CE(sat)}$	Collector-Emitter Saturation Voltage	$I_C = 350\text{ mA}$, $I_B = 500\ \mu\text{A}$	2		1.25	1.6	V
		$I_C = 200\text{ mA}$, $I_B = 350\ \mu\text{A}$	2		1.1	1.3	
		$I_C = 100\text{ mA}$, $I_B = 250\ \mu\text{A}$	2		0.9	1.1	
$I_{I(ON)}$	Input Current	$V_I = 17\text{ V}$	μA9666	3	0.85	1.3	mA
		$V_I = 3.85\text{ V}$	μA9667	3	0.93	1.35	
		$V_I = 5.0\text{ V}$	μA9668	3	0.35	0.5	
		$V_I = 12\text{ V}$		3	1.0	1.45	
$I_{I(OFF)}$	Input Current ²	$T_A = 70^\circ\text{C}$ for Commercial $I_C = 500\ \mu\text{A}$	4	50	65		μA
$V_{I(ON)}$	Input Voltage ³	$V_{CE} = 2.0\text{ V}$, $I_C = 300\text{ mA}$	μA9666	5		13	V
		$V_{CE} = 2.0\text{ V}$, $I_C = 200\text{ mA}$	μA9667	5		2.4	
		$V_{CE} = 2.0\text{ V}$, $I_C = 250\text{ mA}$		5		2.7	
		$V_{CE} = 2.0\text{ V}$, $I_C = 300\text{ mA}$		5		3.0	
		$V_{CE} = 2.0\text{ V}$, $I_C = 125\text{ mA}$	μA9668	5		5.0	
		$V_{CE} = 2.0\text{ V}$, $I_C = 200\text{ mA}$		5		6.0	
		$V_{CE} = 2.0\text{ V}$, $I_C = 275\text{ mA}$		5		7.0	
		$V_{CE} = 2.0\text{ V}$, $I_C = 350\text{ mA}$		5		8.0	
h_{FE}	DC Forward Current Transfer Ratio	$V_{CE} = 2.0\text{ V}$, $I_C = 350\text{ mA}$	μA9665	2	1000		
C_I	Input Capacitance				15	30	pF
t_{PLH}	Turn-On Delay	$0.5\ V_I$ to $0.5\ V_O$			1.0	5.0	μs
t_{PHL}	Turn-Off Delay	$0.5\ V_I$ to $0.5\ V_O$			1.0	5.0	μs
I_R	Clamp Diode Leakage Current	$V_R = 50\text{ V}$	6			50	μA
V_F	Clamp Diode Forward Voltage	$I_F = 350\text{ mA}$	7		1.7	2.0	V

Notes

- All limits stated apply to the complete Darlington series except as specified for a single device type.
- The $I_{I(OFF)}$ current limit guaranteed against partial turn-on of the output.
- The $V_{I(ON)}$ voltage limit guarantees a minimum output sink current per the specified test conditions.

Typical Performance Curves

Collector Current vs Saturation Voltage

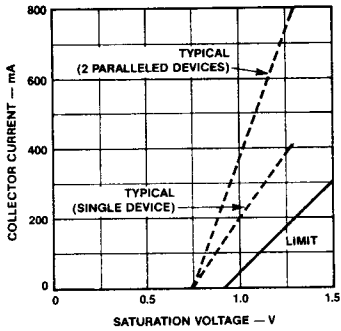

PC06231F

Collector Current vs Input Current

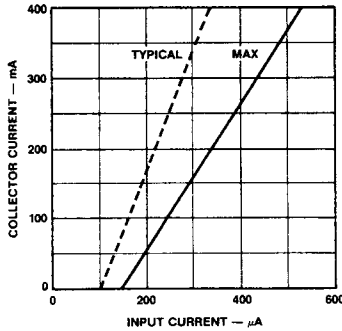

PC06241F

μ A9666 Input Current vs Input Voltage

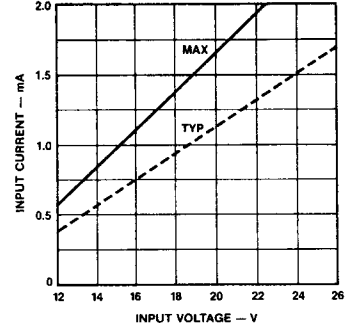

PC06251F

μ A9667 Input Current vs Input Voltage

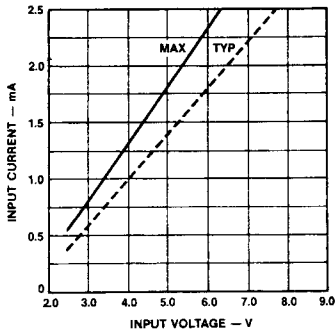

PC06261F

μ A9668 Input Current vs Input Voltage

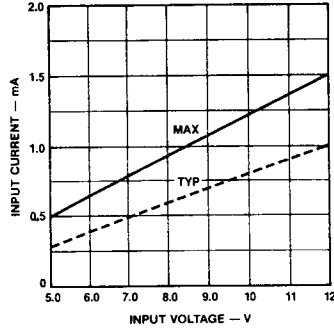

PC06271F

Peak Collector Current vs Duty Cycle and Number of Outputs (Molded Package)

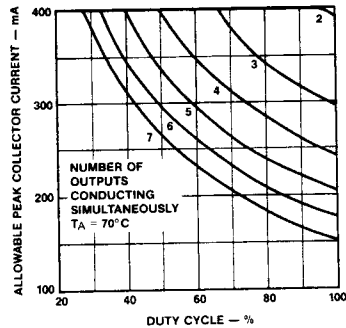

PC06291F

Peak Collector Current vs Duty Cycle and Number of Outputs (Ceramic Package)

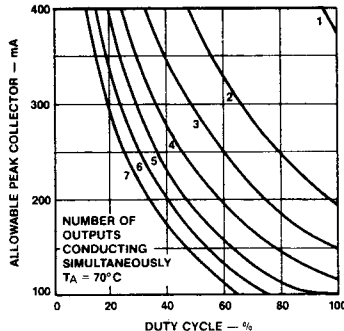

PC06301F

Test Circuits

Figure 1a

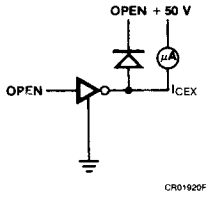

Figure 3

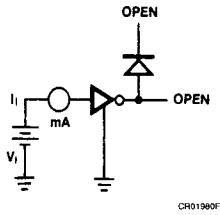

Figure 6

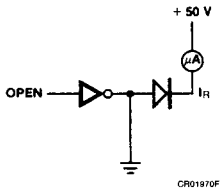

Figure 1b

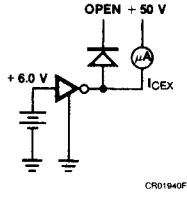

Figure 4

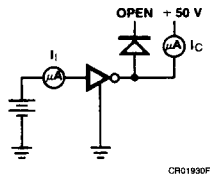

Figure 7

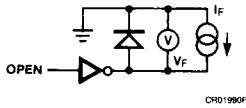

Figure 2

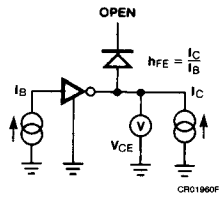
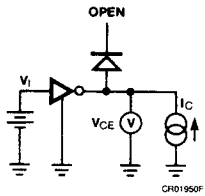
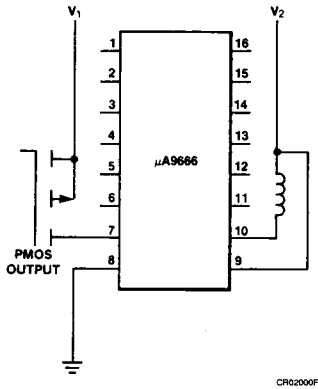

Figure 5



Typical Applications

PMOS to Load



Buffer for Higher Current Loads

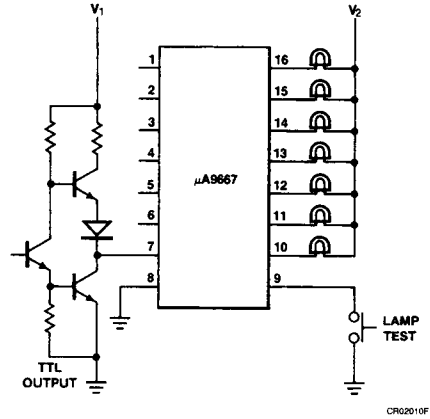

TTL to Load

