

January 26, 1999

Preliminary

MSM9562/63/66/67

IC for FM Multiplex Demodulation

User's Manual
[Control Flow]

Oki Electric Co., Ltd.
Version 0.9

IMPORTANT NOTICE

DARC (DATA Radio Channel), an FM multiplex broadcast technology, has been developed by NHK (Japan Broadcasting Corporation). DARC is a registered trademark of NHK Engineering Service (NHK-ES).

Any manufacturer who intends to manufacture/sell products that utilize DARC technology needs to be licensed by NHK-ES.

For detailed information on licenses, please contact:

NHK Engineering Service

Phone: (+81) 3-3481-2650



DARC (DATA Radio Channel), an FM multiplex broadcast technology, has been developed by NHK (Japan Broadcasting Corporation). DARC is a registered trademark of NHK Engineering Service (NHK-ES).

Any manufacturer licensed by NHK-ES can manufacture and sell products that utilize the DARC technology. The products utilizing the DARC technology can be marked with the logotype shown to the left.

In the DARC system, 16kbps of digital data L-MSK modulated at 76KHz are multiplied on an ordinary FM broadcast base band signal.

An FM multiplex demodulation LSI performs decoding of the digital data signal.

For detailed information on license, please contact:

NHK Engineering Service Phone: 81-3-3481-2650

NOTICE

1. The information contained herein can change without notice owing to product and/or technical improvements. Before using the product, please make sure that the information being referred to is up-to-date.
2. The outline of action and examples for application circuits described herein have been chosen as an explanation for the standard action and performance of the product. When planning to use the product, please ensure that the external conditions are reflected in the actual circuit, assembly, and program designs.
3. When designing your product, please use our product below the specified maximum ratings and within the specified operating ranges including, but not limited to, operating voltage, power dissipation, and operating temperature.
4. Oki assumes no responsibility or liability whatsoever for any failure or unusual or unexpected operation resulting from misuse, neglect, improper installation, repair, alteration or accident, improper handling, or unusual physical or electrical stress including, but not limited to, exposure to parameters beyond the specified maximum ratings or operation outside the specified operating range.
5. Neither indemnity against nor license of a third party's industrial and intellectual property right, etc. is granted by us in connection with the use of the product and/or the information and drawings contained herein. No responsibility is assumed by us for any infringement of a third party's right which may result from the use thereof.
6. The products listed in this document are intended for use in general electronics equipment for commercial applications (e.g., office automation, communication equipment, measurement equipment, consumer electronics, etc.). These products are not authorized for use in any system or application that requires special or enhanced quality and reliability characteristics nor in any system or application where the failure of such system or application may result in the loss or damage of property, or death or injury to humans. Such applications include, but are not limited to, traffic and automotive equipment, safety devices, aerospace equipment, nuclear power control, medical equipment, and life-support systems.
7. Certain products in this document may need government approval before they can be exported to particular countries. The purchaser assumes the responsibility of determining the legality of export of these products and will take appropriate and necessary steps at their own expense for these.
8. No part of the contents contained herein may be reprinted or reproduced without our prior permission.
9. MS-DOS is a registered trademark of Microsoft Corporation.

Copyright 1999 Oki Electric Industry Co., Ltd.

CONTENTS

1. Modes

1.1 Operating Modes	1
1.2 Frame Format	1
Figure 1.1 Main Channel Mode Reception	2
Figure 1.2 Switched Reception Between Main Channel Mode and Sub-Channel Mode	3
Figure 1.3 Page Mode Reception	4

2. Control Flow Examples

2.1 Normal Reception	5
2.1.1 Total Flow	5
2.1.2 Total Configuration	5
2.1.3 Interrupts	5
2.1.4 User RAM Configuration	6
Table 2.1.4 User RAM Contents	6
2.1.5 Description of Each Flow	7
Figure 2.1.1 Total Flow	8
Figure 2.1.2 Total Configuration	9
Figure 2.1.3 Simplified Interrupt Flow	10
Figure 2.1.4 USR_RAM Configuration	11
Figure 2.1.5.1 Power-On Control Flow	12
Table 2.1 Recommended Parameter Setting Values	13
Table 2.2 Registers That Do Not Require Parameter Setting	13
Figure 2.1.5.2 Initial Parameter Setting	14
Figure 2.1.5.3 Main Channel Activation	14
Figure 2.1.5.4 Main Channel Switched Reception	14
Figure 2.1.5.5 Main Channel Halt	15
Figure 2.1.5.6 Interrupt Control	16
Figure 2.1.5.7 Receive _MAIN After 1 st Horizontal Error Correction	17
Figure 2.1.5.8 Reception After 2 nd Horizontal Error Correction	18
Figure 2.1.5.9 Status Monitor	19
2.2 Main/Sub Switched Reception	20
2.2.1 Total Flow	20
2.2.2 Total Configuration	20
2.2.3 Interrupts	21
2.2.4 User RAM Configuration	21
Table 2.2.4 User RAM Contents	22
2.2.5 Description of Each Flow	23
Figure 2.2.1.1 Main/Sub Switched Reception Block Diagram	26
Figure 2.2.1.2 Total Flow	27
Figure 2.2.1.3-1/2 Main/Sub Switched Reception Timing	28
Figure 2.2.1.3-2/2 Main/Sub Switched Reception Timing	29
Figure 2.2.2 Total Configuration	30
Figure 2.2.3 Simplified Interrupt Flow	31
Figure 2.2.4 USR_RAM Configuration	32
Figure 2.2.5.1 Power-On Control Flow	33
Table 2.3 Recommended Parameter Setting Values	34
Table 2.4 Registers That Do Not Require Parameter Setting	34

Figure 2.2.5.2	Initial Parameter Setting	35
Figure 2.2.5.3	Main Channel Activation	35
Figure 2.2.5.4	Main Channel Switched Reception	35
Figure 2.2.5.5	Sub Channel Activation	36
Figure 2.2.5.6	Halting the SUB Channel	37
Figure 2.2.5.7	Halting the Main Channel	38
Figure 2.2.5.8	Interrupt Control	39
Figure 2.2.5.9	Frame Timing Setup _SUB	40
Figure 2.2.5.10	Reception After 2nd Horizontal Error Correction	41
Figure 2.2.5.11	Status Monitor	42
Figure 2.2.5.12	SUB Control	43
Figure 2.2.5.13	Sub Channel Connection	44
Figure 2.2.5.14	Receive _SUB After 1 st Horizontal Error Correction	45
Figure 2.2.5.15	Main Channel Connection	46
Figure 2.2.5.16	Bit Displacement Compensation	47

MSM9562/63/66/67 Control Flow

1. Modes

1.1 Operating Modes

This IC has three reception modes.

- (1) A main channel mode (conventional method) that continuously receives data from a single broadcast station and outputs the received data in units of packets and frames
- (2) A sub-channel mode that receives data by switching a tuner at high-speed between one broadcast station (main station) and another broadcast station (sub-station), and outputs the sub-station receive data in packet units
(During sub-station reception, missing main station packets can be regenerated by error correction. Therefore, by watching for missing packets, simultaneous reception of the main station and sub-station is possible.)
- (3) A page mode that writes the 1st horizontal receive data to frame memory and outputs the collective packets receive during a specific time interval

Figures 1.1 to 1.3 show the receive operation of each receive mode.

Applications of the sub-channel mode include simultaneous reception an FM multiplexed broadcast program on one channel and packet data on another channel.
The page mode can be applied to pager or high-speed broadcast program verification.

Each mode can be switched to another mode.

1.2 Frame Format

This IC fully supports international standard frame formats A0, A1, B (Japan) and C. High-speed switching of each frame format is also possible.

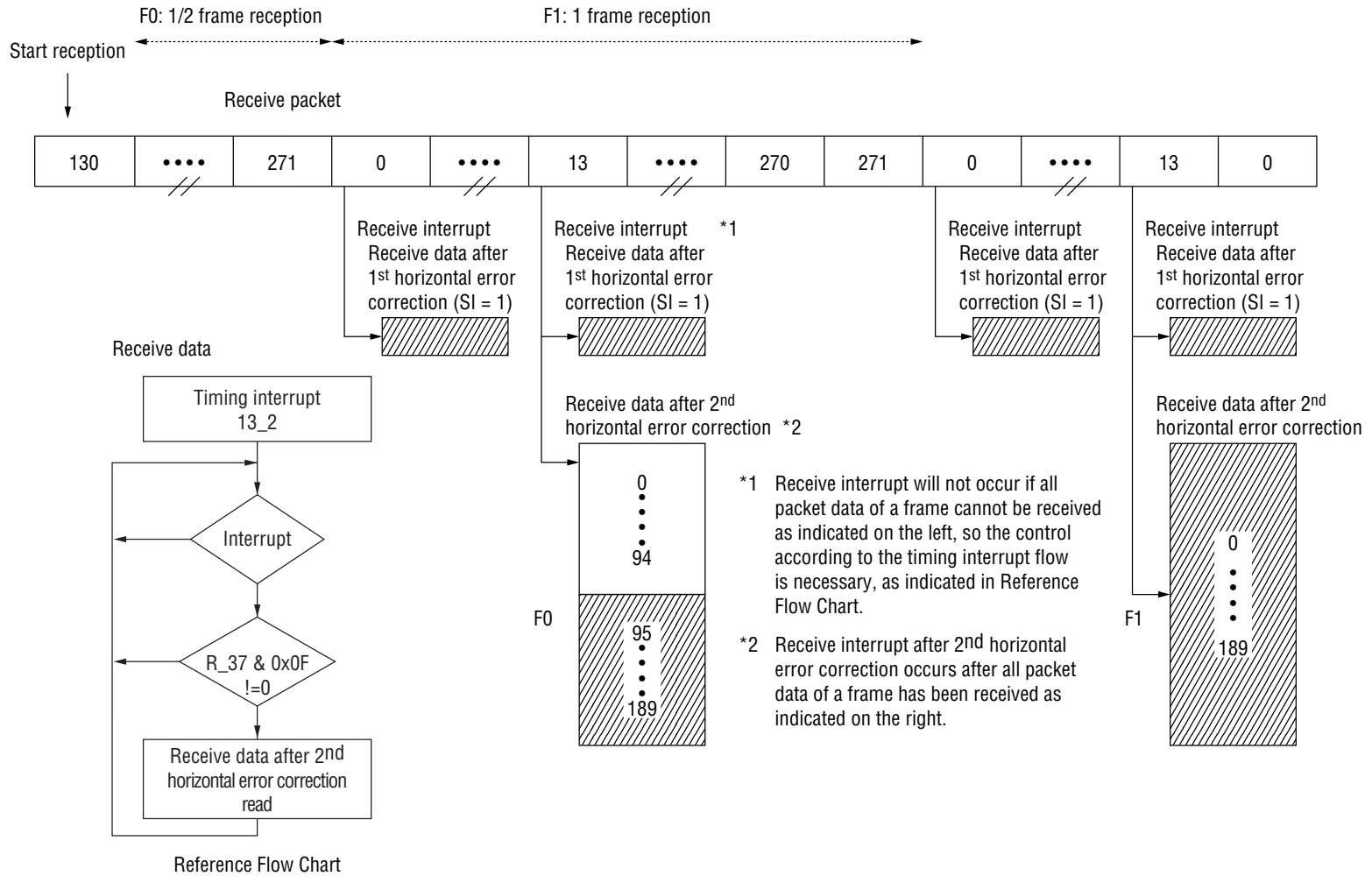

Figure 1.1 Main Channel Mode Reception
(Case where only SI = 1 at reception after the first horizontal error correction)

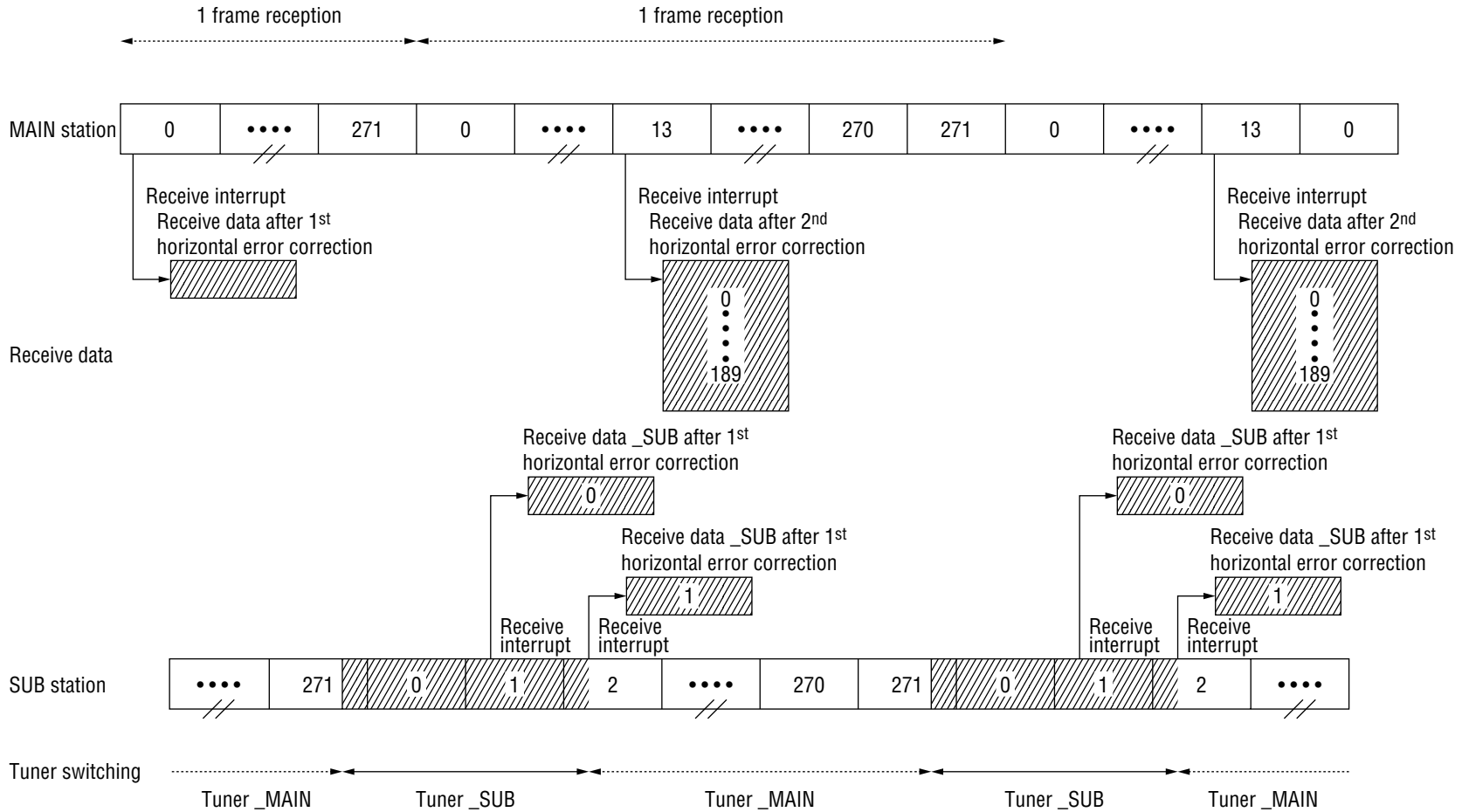

Figure 1.2 Switched Reception Between Main Channel Mode and Sub-Channel Mode

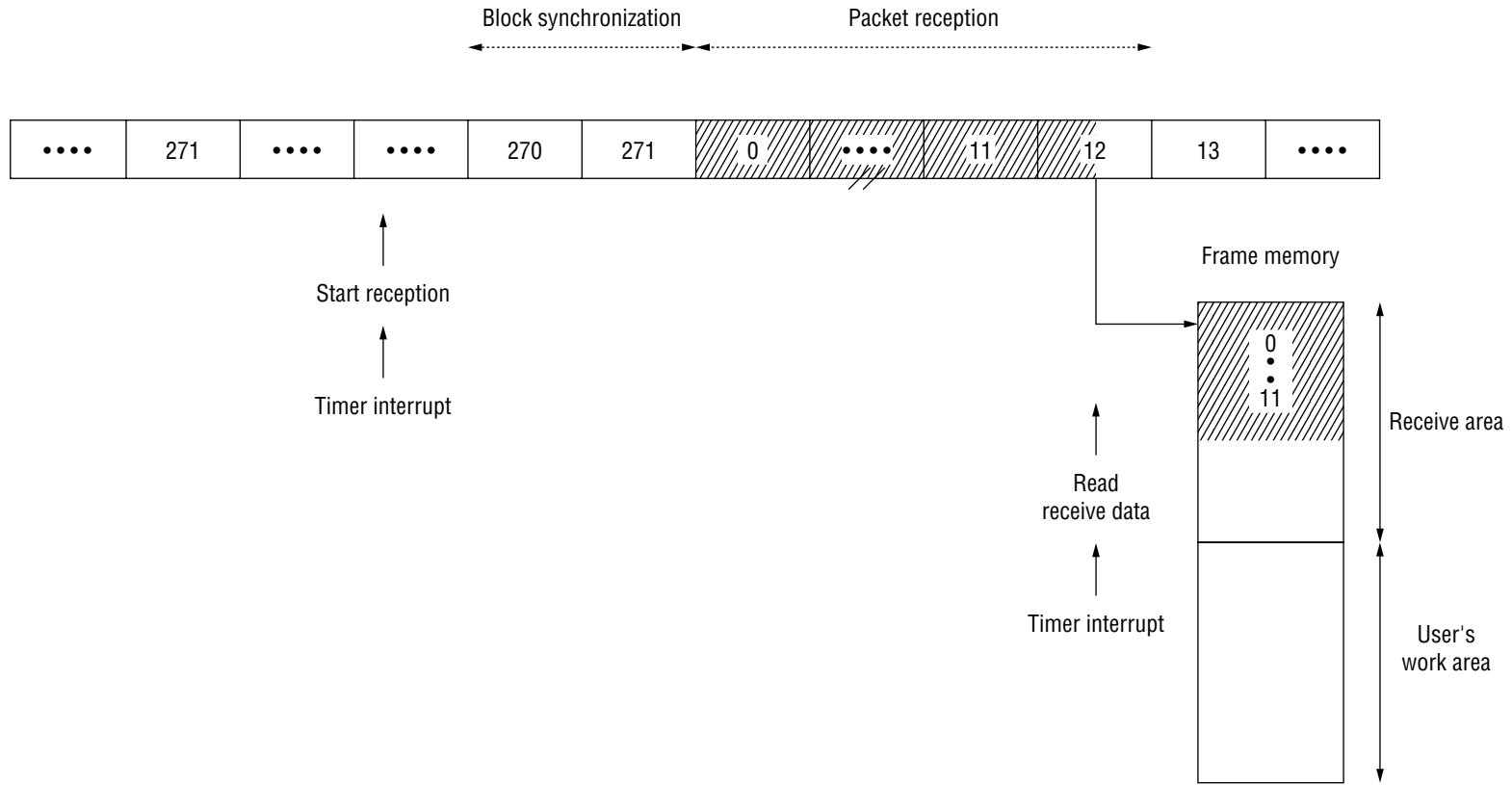

Figure 1.3 Page Mode Reception

2. Control Flow Examples

2.1 Normal Reception

This flow example indicates the control flow of receive _MAIN after the 1st horizontal error correction, and of reception after the 2nd horizontal error correction.

2.1.1 Total Flow

Figure 2.1.1 shows the total flow.

The total flow can be changed by the following three controls.

- Power-on/receive start (power-on 2/receive start 3)
- Switching the MAIN channel
- Halting operation

2.1.2 Total Configuration

Figure 2.1.2 shows the total configuration.

This figure shows the total flow control and the function of interrupts.

Controls that manage the total flow such as MAIN reception or halting operation are executed from the main program. It is not necessary to synchronize these controls with the IC.

The transfer of receive data (layer 3 data) after the 2nd horizontal error correction or receive _MAIN data after the 1st horizontal error correction to the USR_RAM, modification and display of this receive data, display of the synchronous state of the FM multiplexing IC, etc. are performed by interrupt control. This control must be synchronized with an IC interrupt.

2.1.3 Interrupts

Figure 2.1.3 shows the flow of interrupt processing.

2.1.4 User RAM Configuration

Figure 2.1.4 shows the configuration of user RAM and table 2.1.4 shows the contents of user RAM utilized in this flow.

Table 2.1.4 User RAM Contents

1	(R_00)	Content of interrupt register R_00 that was read
2	(R_01)	Content of interrupt mask register R_01 that was written
3	(R_04)	Content of channel connection register R_04 that was written
4	(R_05)	Content of timing interrupt register R_05 that was written
5	(R_1A)	Display of frame sync monitor R_1A that was read (4 times/1 frame)
6	(R_34)	Content of interrupt condition register R_34 that was written
7	(R_37)	Display of receive status register R_37 (1 time/1 frame at receive interrupt after 2 nd horizontal error correction)
8	PacketNo_MAIN	Packet number of main channel when an interrupt (main channel) is generated
9	2 nd horizontal data update flag	Display at completion of receive data read after 2 nd horizontal error correction
10	N	Number of block transfers 1 to 5: Receive data exists after 2 nd horizontal error correction 0: No receive data after 2 nd horizontal error correction
11	i	2 nd horizontal error correction USR_RAM pointer To simplify explanation, cleared to "0" at reset
12	2 nd horizontal USR_RAM	Buffer area for receive data that was read after 2 nd horizontal error correction
13	j	1 st horizontal error correction USR_RAM_SUB pointer To simplify explanation, cleared to "0" at reset
14	1 st horizontal USR_RAM	Buffer area for receive data that was read after 1 st horizontal error correction

2.1.5 Description of Each Flow

Control of the total flow is indicated in items (1) to (5).

- (1) Power-on control flow
Shown in figure 2.1.5.1.
- (2) Initial parameter setting
Table 2.1 lists recommended parameter setting values and table 2.2 lists registers in which parameter setting is unnecessary. Figure 2.1.5.2 shows the parameter setting flow.
- (3) MAIN channel activation
Shown in figure 2.1.5.3.
- (4) MAIN channel switching
Shown in figure 2.1.5.4.
- (5) MAIN channel halting
Shown in figure 2.1.5.5.

Interrupt control of the MAIN channel is indicated in items (6) to (9).

- (6) Interrupt control
Shown in figure 2.1.5.6.
- (7) Receive _MAIN after 1st horizontal error correction
Shown in figure 2.1.5.7.
- (8) Reception after 2nd horizontal error correction
Shown in figure 2.1.5.8.
If there is a receive interrupt after the 2nd horizontal error correction, set the receive port (R_38) pointer to "0." Because the quantity of data is large, if the data cannot all be read at once (approx. 10 ms), divide it into several packets and then read the data.
In this example, data is divided into N = 5 packets and is read five times. Interrupts are set at each packet timing. When N = 0 and the read is completed, interrupts are released at each packet timing, and after the 2nd horizontal error correction, update and display data is written.
- (9) Status monitor
Shown in figure 2.1.5.9.

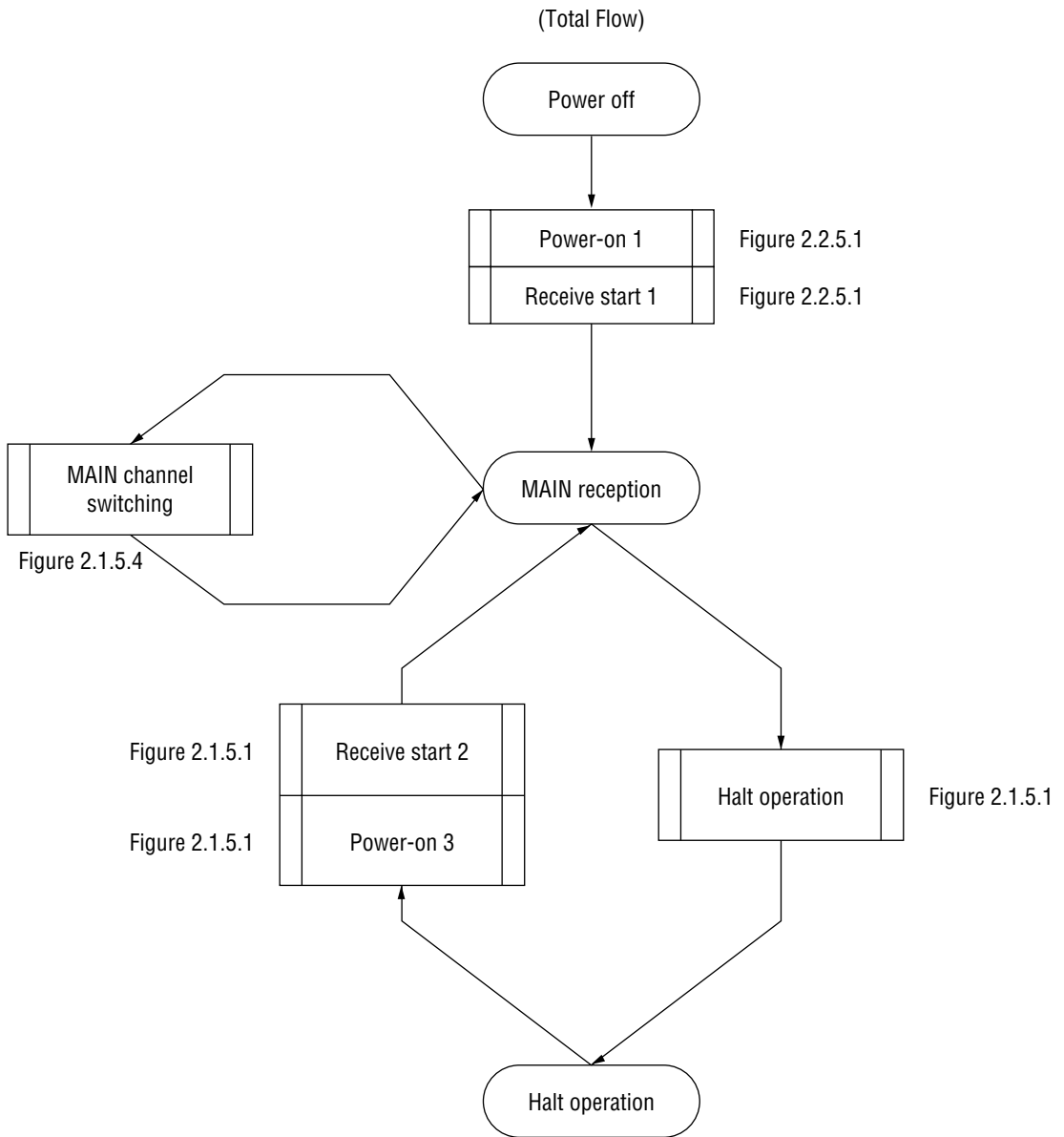

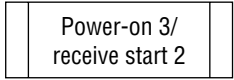
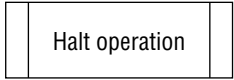
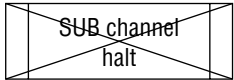
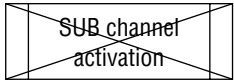
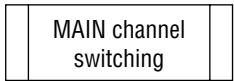
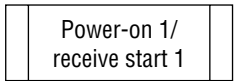

- Interrupts
- Timing _MAIN
 - Receive _MAIN after 1st horizontal error correction
 - Receive _MAIN after 2nd horizontal error correction

Power-on 1/receive start 1

MAIN channel switching

~~SUB channel activation~~

~~SUB channel stop~~

Halt operation

Power-on 3/receive start 2

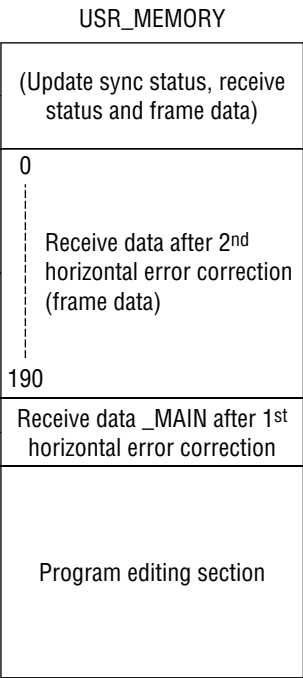
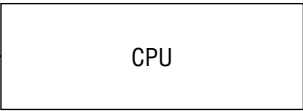

Timing interrupt (4 times/frame)

Timing/Interrupt after 2nd horizontal error correction

(5 times/frame)

Receive interrupt _MAIN after 1st horizontal error correction

Figure 2.1.2 Total Configuration

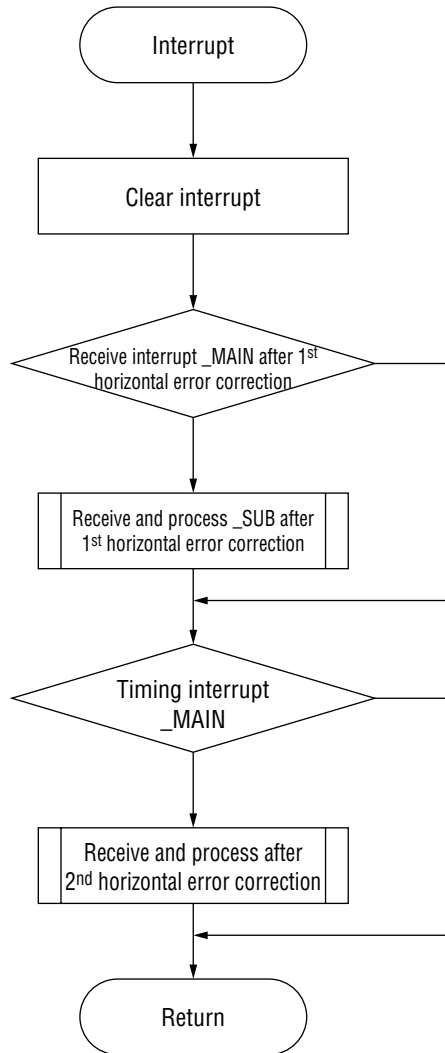
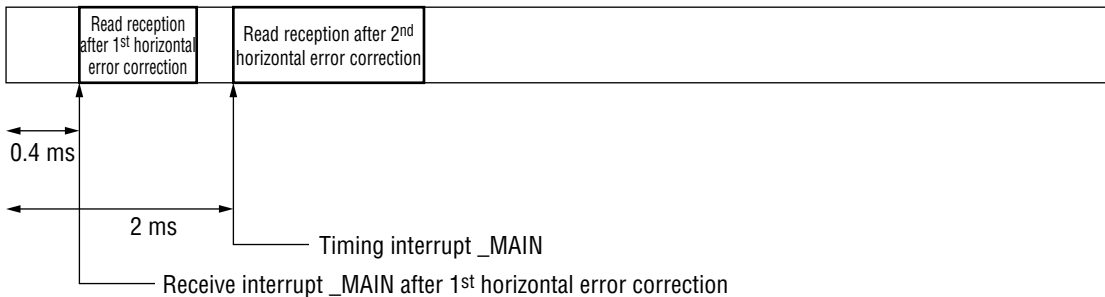

Figure 2.1.3 Simplified Interrupt Flow

Case where receive _MAIN after 1st horizontal error correction and timing interrupt _MAIN occur in the same packet



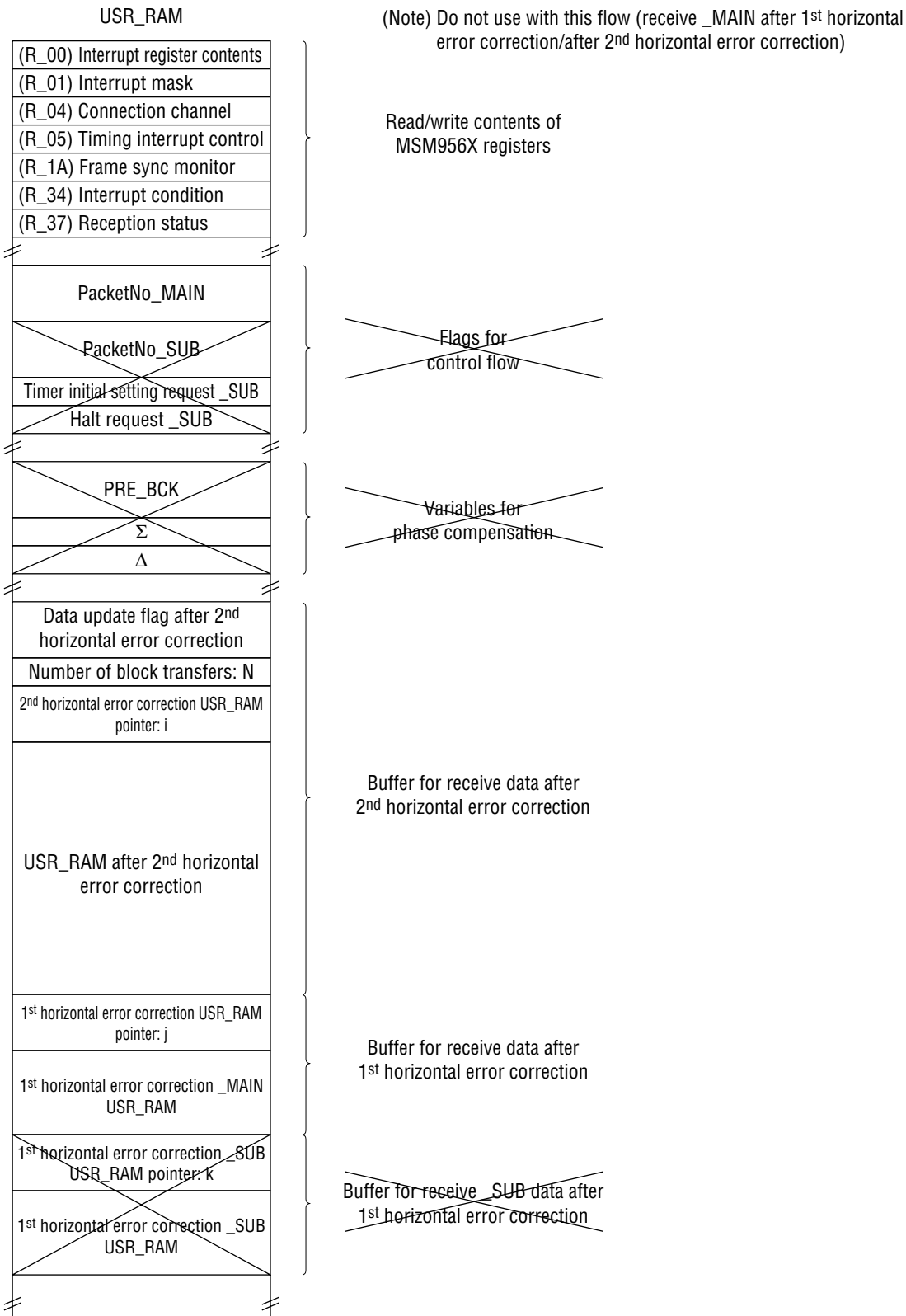

Figure 2.1.4 USR_RAM Configuration

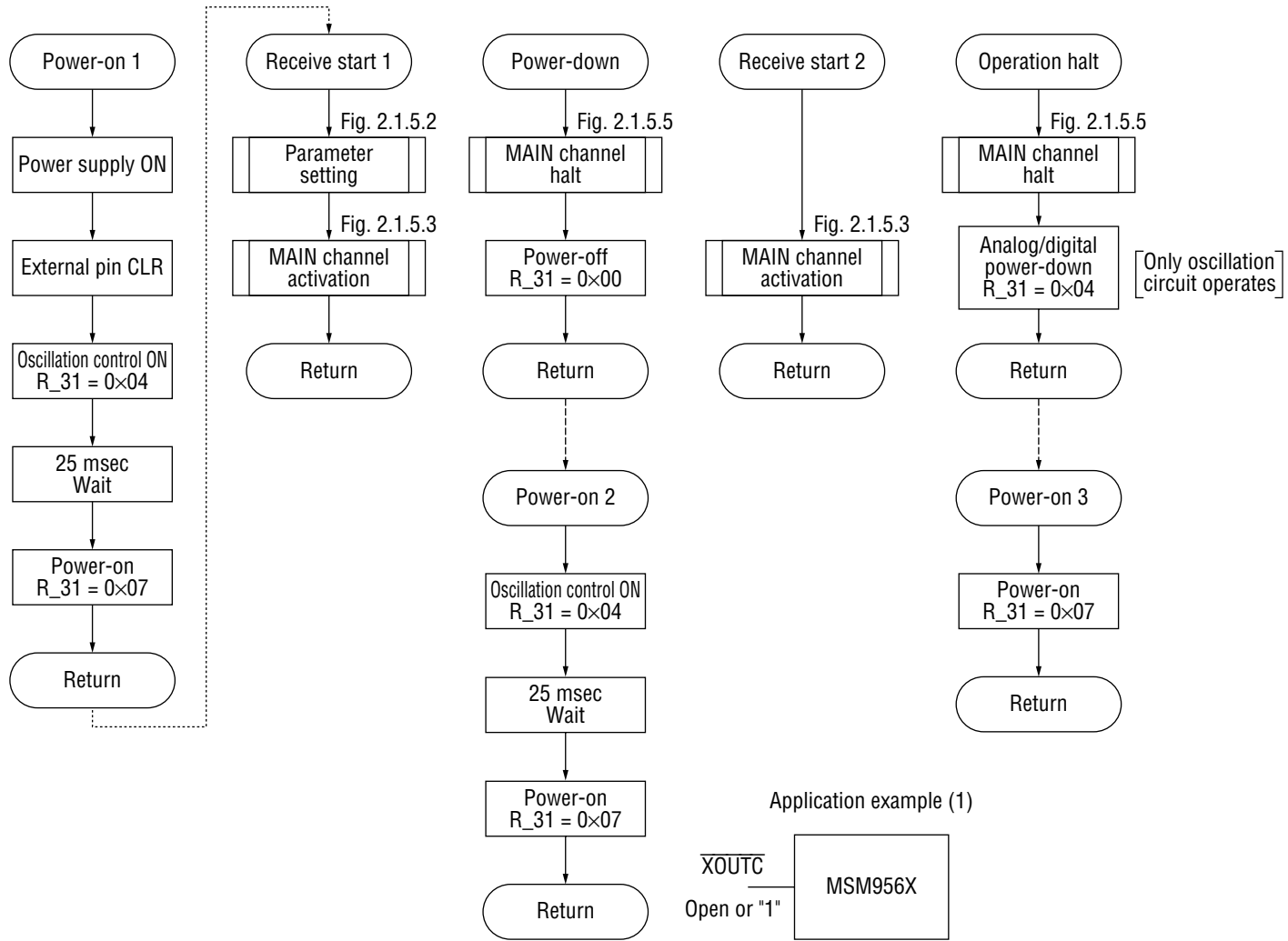

Figure 2.1.5.1 Power-On Control Flow

Table 2.1 Recommended Parameter Setting Values

Register	Address	Setting value	Description
Interrupt mask	0x01	0x36	Receive _MAIN after 1 st horizontal error correction = timing _MAIN = "1" After 2 nd horizontal error correction, setting is unnecessary since receive _MAIN and sync displacement are determined at time of R_00 read.
Integration constant before block synchronization	0x0C	0x06	6
Integration constant after block synchronization	0x0D	0x10	16
Phase correction step	0x0E	0x33	4/4MHz
Allowable Number of BIC Error Bits	0x10	0x09	Before synchronization: 1 After synchronization: 2
No. of Block Sync Backward Protection Steps	0x11	0x12	SUB = 1 MAIN = 2
No. of Block Sync Forward Protection Steps	0x12	0x4F	SUB = 4 MAIN = 15
No. of Frame Sync Backward Protection Steps	0x18	0x00	1
No. of Frame Sync Forward Protection Steps	0x19	0x04	4
DDJ mode *	0x28	0xA0	1 st horizontal error correction/2 nd horizontal error correction mode
Analog	0x30	0x06	DETO_DTST: invalid, ADETIN: invalid Amp gain: ×3, DETTC: invalid
TST1	0x33	0x04	PN decoding: on, Differential decoding: off, Monitor: off

* For MSM9566/67 only

Table 2.2 Registers That Do Not Require Parameter Setting

Register	Address	Initial value	Description
Receive port switching after 1 st horizontal error correction	0x02	0x00	Use initial value of receive _MAIN after 1 st horizontal error correction
Main/sub channel switching	0x04	0x01	Use initial value of main channel (no switching)
Fixed phase adjustment	0x0B	0x00	Setting unnecessary
Clear/set block sync	0x14	0x00	Setting unnecessary
Clear sync	0x1B	0x00	Setting unnecessary
Set sync	0x1C	0x00	Setting unnecessary
Frame format	0x1F	0x02	B format
Error correction	0x20 to 0x22	0x00	Not used
Number of error corrections	0x23	0xFB	Use initial value
Number of error corrections/threshold value	0x25	0xEE	Use initial value
Operating mode	0x3E	0x00	Use initial value

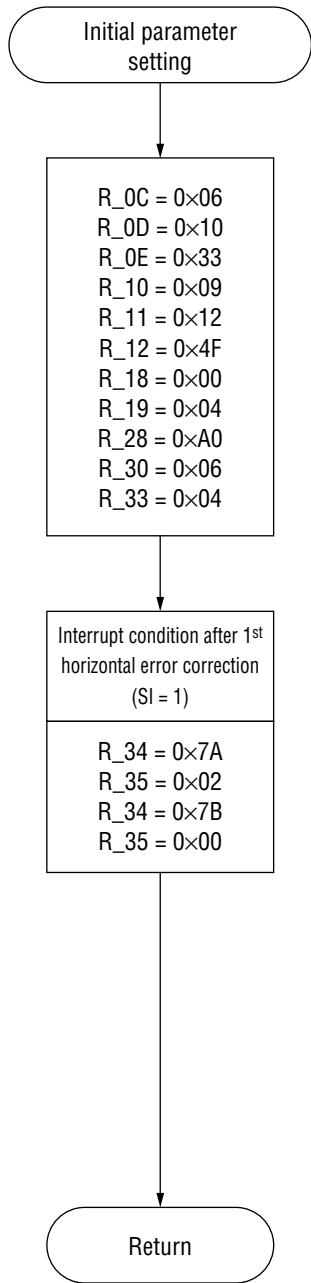

Figure 2.1.5.2
Initial Parameter Setting

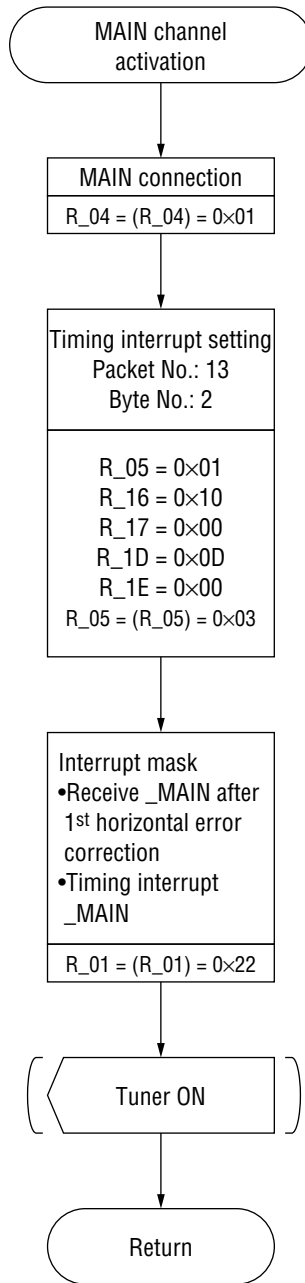

Figure 2.1.5.3
Main Channel Activation

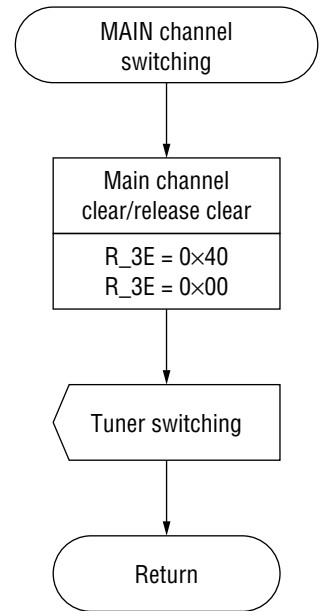

Figure 2.1.5.4
**Main Channel Switched
 Reception**

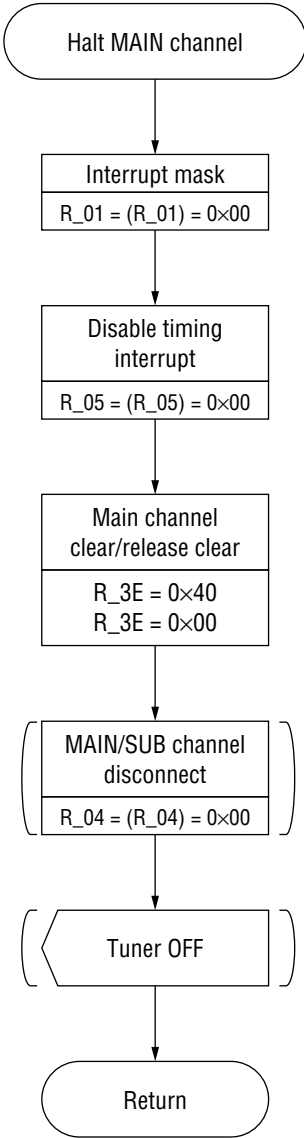

Figure 2.1.5.5 Main Channel Halt

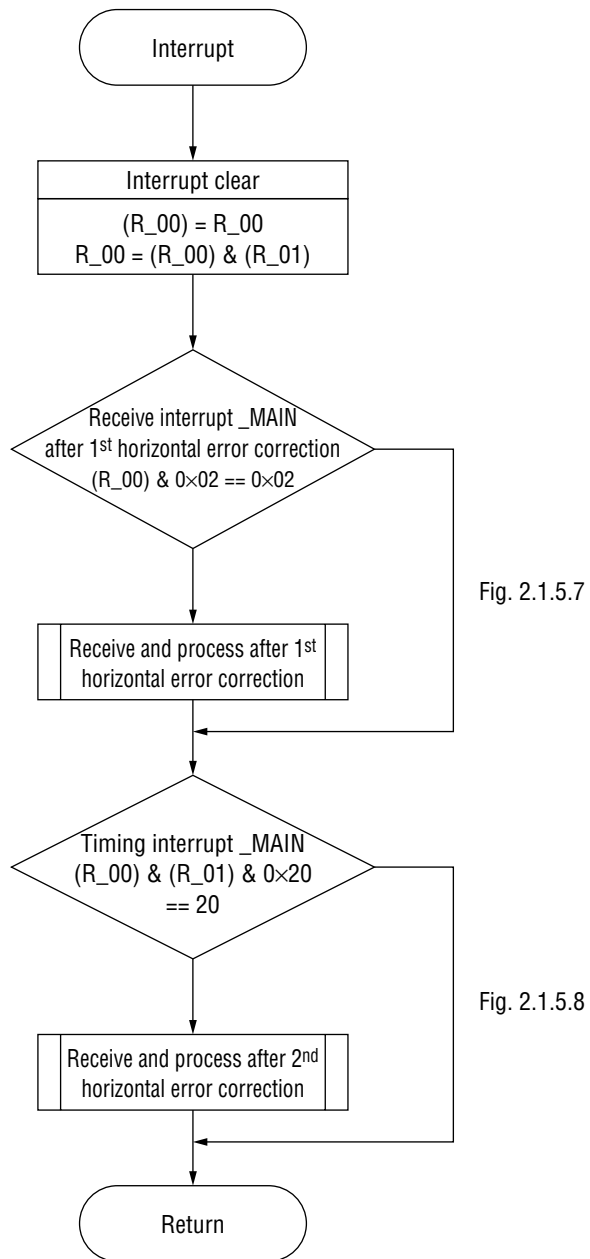

Figure 2.1.5.6 Interrupt Control

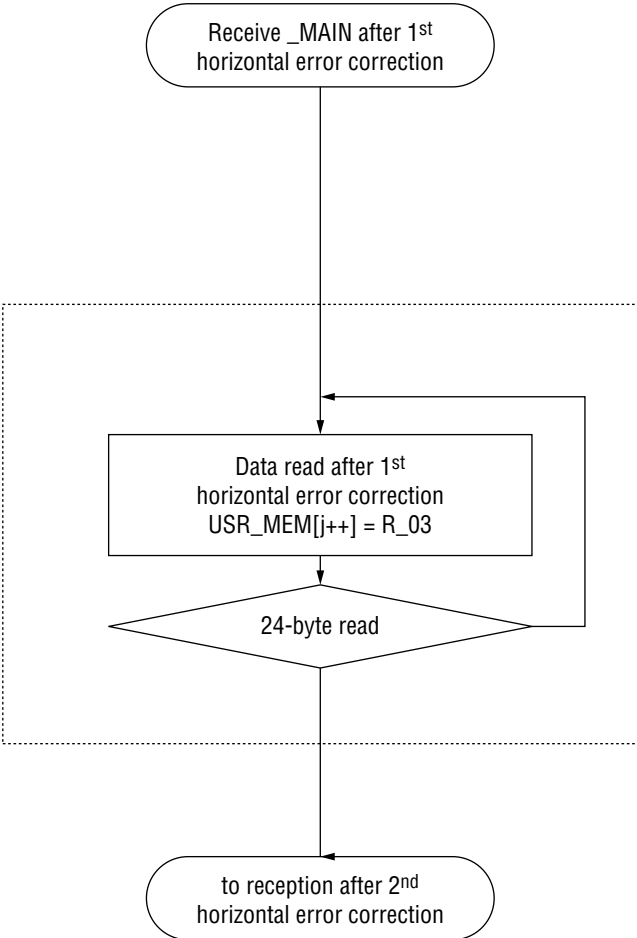

Figure 2.1.5.7 Receive _MAIN After 1st Horizontal Error Correction

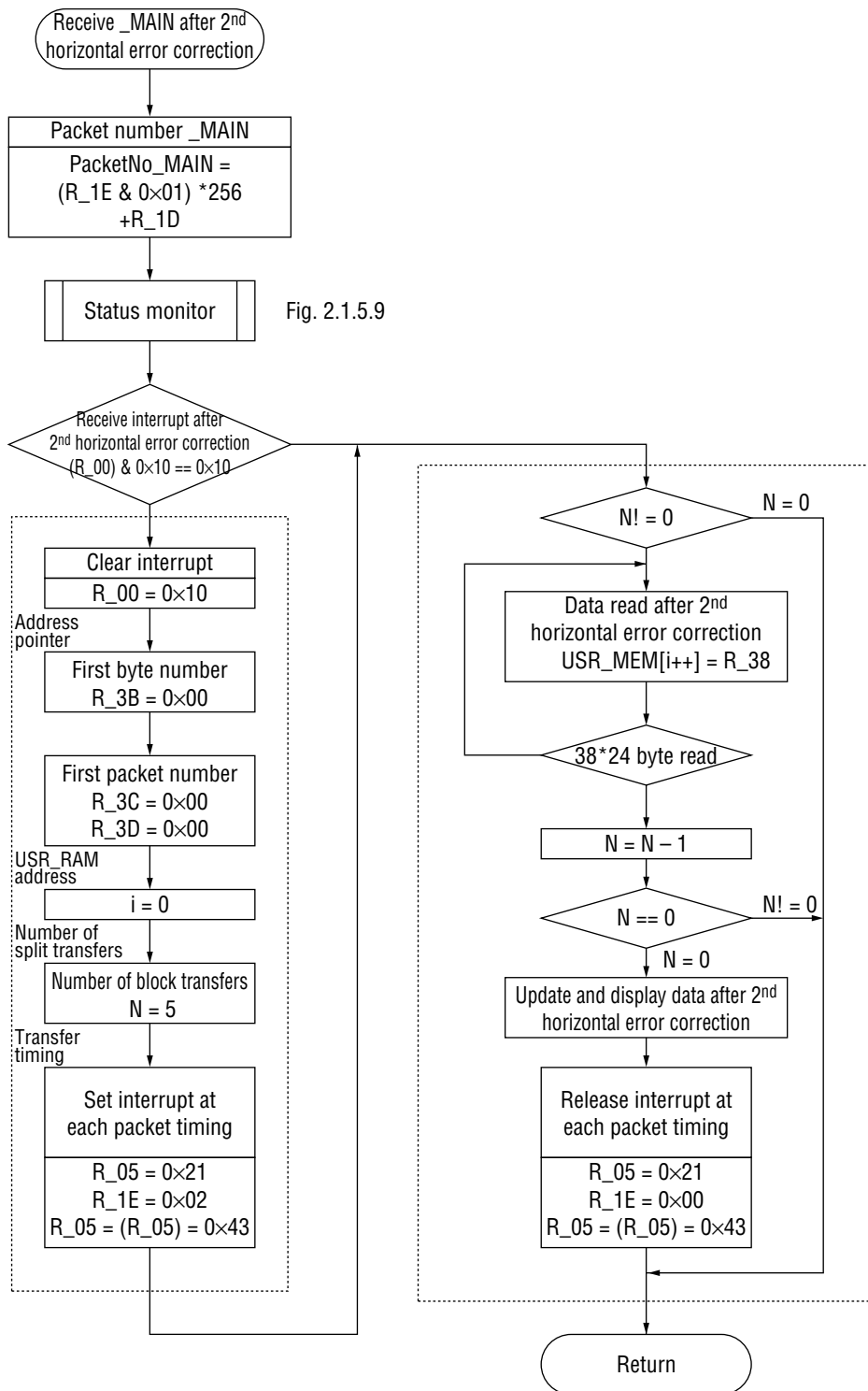

Fig. 2.1.5.9

Figure 2.1.5.8 Reception After 2nd Horizontal Error Correction

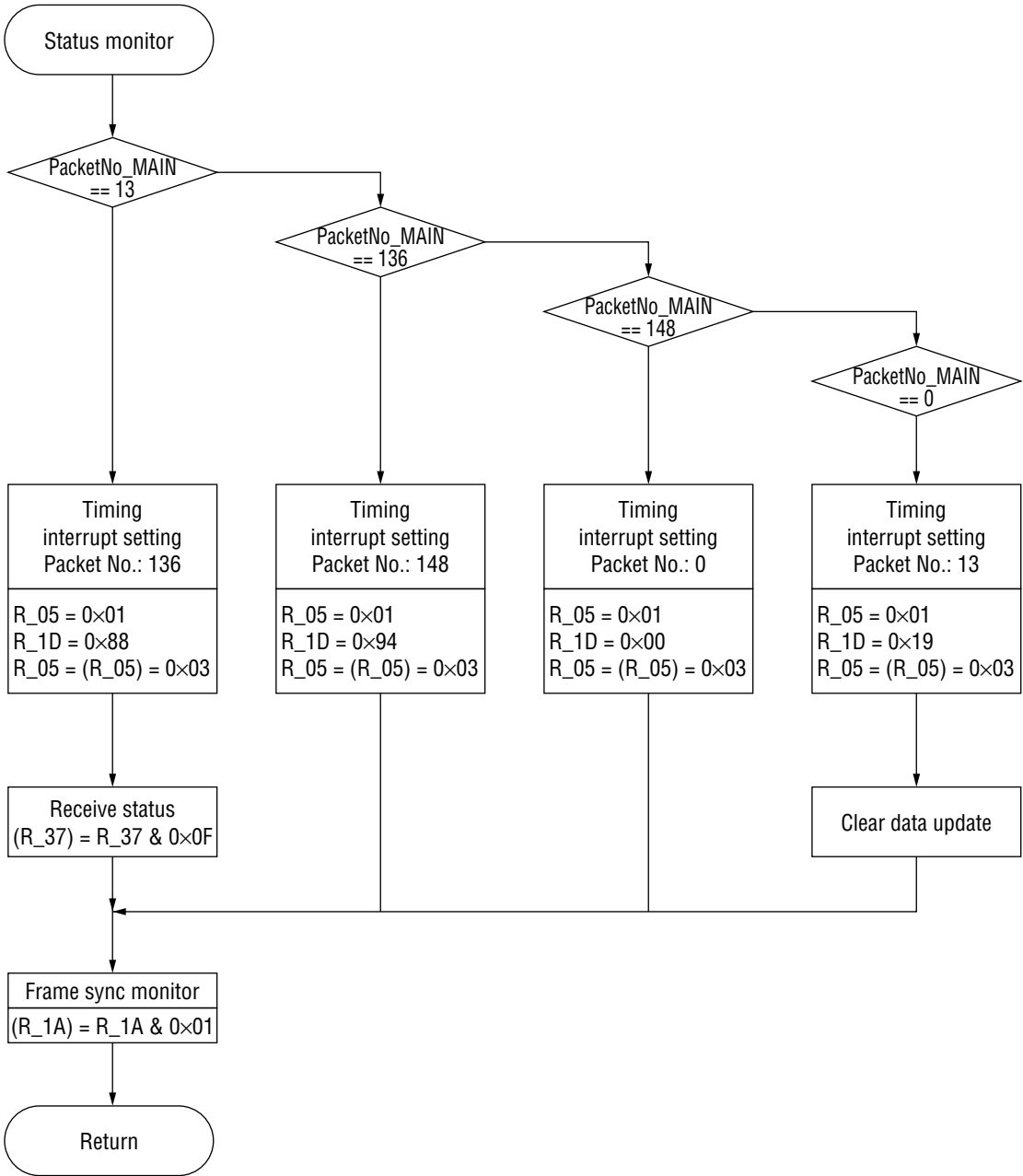

Figure 2.1.5.9 Status Monitor

2.2 Main/Sub Switched Reception

An example of the control flow of main/sub switched reception is listed below.

- (1) This example indicates the control flow of the receive _MAIN after the 2nd horizontal error correction and the receive _SUB after the 1st horizontal error correction. The receive _MAIN after the 1st horizontal error correction is omitted.
- (2) This example assumes that the sub-channel reception time includes: tuner switching time of 1×2 packets, clock capture time of 1/3 packet, and block synchronization time of 1 packet. In this case, 5.5 packets (including receive packet 2) disappear from the main channel.

2.2.1 Total Flow

- (1) Figure 2.2.1.1 shows the block diagram.
- (2) Figure 2.2.1.2 shows the total flow.
The total flow can be changed by the following five controls
 - Power-on/receive start (power-on 2/receive start 3)
 - Switching the MAIN channel
 - Activating the SUB channel
 - Halting the SUB channel
 - Halting operation
- (3) Figure 2.2.1.3-1/2 and figure 2.2.1.3-2/2 show the main/sub switching timing. Main channel packets are shown on the left and sub-channel packets on the right. To simplify this example, the packets have matching starting positions. In an actual application these positions are displaced, however details of the explanation do not change.

2.2.2 Total Configuration

Figure 2.2.2 shows the total configuration.

This figure shows the total flow control and the function of interrupts.

Controls that manage the total flow such as MAIN reception, MAIN/SUB switched reception, halting operation, etc. are executed from the main program. It is not necessary to synchronize these controls to the IC.

The transfer of receive data (Layer 3 data) after the 2nd horizontal error correction or of receive _SUB data after the 1st horizontal error correction to the USR_RAM, modification and display of this receive data, display of the synchronous state of the FM multiplexing IC, etc. are performed by interrupt control. This control must be synchronized with an IC interrupt.

2.2.3 Interrupts

Figure 2.2.3 shows a simplified flow of interrupt processing.

2.2.4 User RAM Configuration

Figure 2.2.4 shows the configuration of user RAM and table 2.2.4 shows the contents of user RAM utilized in this flow.

Table 2.2.4 User RAM Contents

1	(R_00)	Content of interrupt register R_00 that was read
2	(R_01)	Content of interrupt mask register R_01 that was written
3	(R_04)	Content of channel connection register R_04 that was written
4	(R_05)	Content of timing interrupt register R_05 that was written
5	(R_1A)	Display of frame sync monitor R_1A that was read (4 times/1 frame)
6	(R_34)	Content of interrupt condition register R_34 that was written
7	(R_37)	Display of receive status register R_37 (1 time/1 frame at receive interrupt after 2 nd horizontal error correction)
8	PacketNo_MAIN	Packet number of main channel when an interrupt (main channel) is generated
9	PacketNo_SUB	Packet number of sub channel when an interrupt (sub-channel) is generated
10	Halt request _SUB	Halt request flag for sub-channel reception
11	PRE_BCK	Stores the bit number immediately prior to block synchronization of the sub-channel If there is no bit displacement, the value is 16.
12	Δ	Stores the bit displacement $\Delta = \text{PRE_BCK} - 16$
13	Σ	Stores the bit displacement compensation value ($\Sigma = \Sigma + \Delta$)
14	2 nd horizontal data update flag	Displayed at completion of receive data read after 2 nd horizontal error correction
15	N	Number of block transfers when reading data after the 2 nd horizontal error correction. In this example, transfers are divided into N = 5 times. 1 to 5: Receive data exists after 2 nd horizontal error correction 0: No receive data after 2 nd horizontal error correction
16	i	2 nd horizontal error correction USR_RAM pointer To simplify explanation, cleared to "0" at reset
17	2 nd horizontal USR_RAM	Buffer area for receive data after 2 nd horizontal error correction that was read
18	j	USR_RAM_SUB pointer after 1 st horizontal error correction To simplify explanation, cleared to "0" at reset
19	1 st horizontal USR_RAM_SUB	Buffer area for receive data SUB after 1 st horizontal error correction that was read

2.2.5 Description of Each Flow

Control of the total flow is indicated in items (1) to (7).

- (1) Power-on control flow
Shown in figure 2.2.5.1.
- (2) Initial parameter setting
Table 2.3 lists recommended parameter setting values and table 2.4 lists registers in which parameter setting is unnecessary. Figure 2.2.5.2 shows the parameter setting flow.
- (3) MAIN channel activation
Shown in figure 2.2.5.3.
- (4) MAIN channel switching
Shown in figure 2.2.5.4.
- (5) SUB channel activation
Shown in figure 2.2.5.5.
- (6) SUB channel halting
Shown in figure 2.2.5.6.
- (7) MAIN channel halting
Shown in figure 2.2.5.7.

Interrupt control

- (8) Interrupt control
Shown in figure 2.2.5.8.

Interrupt control of the MAIN channel is indicated in items (9) to (11).

- (9) Frame timing setup _SUB
Shown in figure 2.2.5.9.
If $(R_01) = 0 \times 11$ (MAIN/SUB), since synchronization will be established for the first time with the SUB station, frame timing setup _SUB control is performed.
The control flow initializes settings of the timer _SUB to the packet number of the synchronous SUB station.
The packet number of the MAIN channel is set to the packet number counter (R_08, R_09) of the sub-channel so that the packet numbers are equal. Thereafter, use of timing interrupt _SUB is possible.
Next, the timing is set to switch the tuner to the SUB station (packet number _SUB = 269, byte number = 22).

Since frame timing setup _SUB is completed via the MAIN channel, reception with the MAIN channel is possible. After the 1st horizontal error correction, original receive conditions (R_34) are restored and the receive state of the SUB station is cleared (R_3E). The tuner switches to the MAIN channel and, continuing from step (8), processing of this interrupt is completed.

- (10) Reception after 2nd horizontal error correction
Shown in figure 2.2.5.10.
If there is a receive interrupt after the 2nd horizontal error correction, set the receive port (R_38) pointer to "0". Since the quantity of data is large, if the data cannot be read at once (approx. 10 ms), divide it into several packets and then read the data.
In this example, data is divided into N = 5 packets and is read. Interrupts are set at each packet timing. When N = 0 and the read is completed, interrupts are released at each packet timing, and after the 2nd horizontal error correction, update and display data is written.

- (11) Status monitor
Shown in figure 2.2.5.11.

Interrupt control of the SUB channel is indicated in items (12) to (16).

- (12) SUB control
Shown in figure 2.2.5.12.
Interrupt control of the SUB channel is activated by timer interrupt _SUB.
Depending upon the packet number _SUB of the internal counter that is read, control switches to SUB connection, receive _SUB after 1st horizontal error correction, or main connection.

- (13) SUB connection
Shown in figure 2.2.5.13.
When the SUB station's packet number equals 269, control transfers to this flow.
The channel is set to SUB connection and the tuner is switched from the MAIN station to the SUB station.
Next, the receive timing of the 1st packet _SUB is set (packet number _SUB = 1, byte number = 2). The time until reception of the first packet _SUB consists of the following: tuner switch time, clock capture time, block sync time, and time required for reception of the first packet _SUB.

- (14) Receive _SUB after 1st horizontal error correction
Shown in figure 2.2.5.14.
When packet number of the SUB station equals 1 or 2, control transfers to this flow.
When the receive interrupt is 1 after the 1st horizontal error correction, read 24 bytes of receive data.
When the packet number of the SUB station equals 2, since the packets of the SUB channel are completed, execute various controls (synchronous clear _SUB, SUB disconnect, switch the tuner from the SUB station to the MAIN station) to complete processing of this interrupt.

- (15) MAIN channel connection
Shown in figure 2.2.5.15.
When the packet number of the SUB station equals 3, control transfers to this flow and connects the MAIN channel. When packet number _SUB equals 2, the switched tuner is stabilized and main channel reception can be resumed while maintaining the synchronous status when disconnected with a packet number of 269.

(16) Bit displacement compensation

Shown in figure 2.2.5.16.

After several consecutive frames, even if the packet number of the SUB station cannot be received, bit displacement compensation is performed to enable SUB connection with accurate timing.

7 bits can be compensated with 1 instruction. Bit compensation of up to 7 bits is implemented during the second packet reception of step (6). In the case of compensation of 8 bits or more, compensation of the remainder is implemented when MAIN channel connection of step (7) is 3.

Σ is the previous bit compensation number and Δ is the bit displacement detected this time. Control of bit displacement compensation is required regardless of whether or not there is a receive packet.

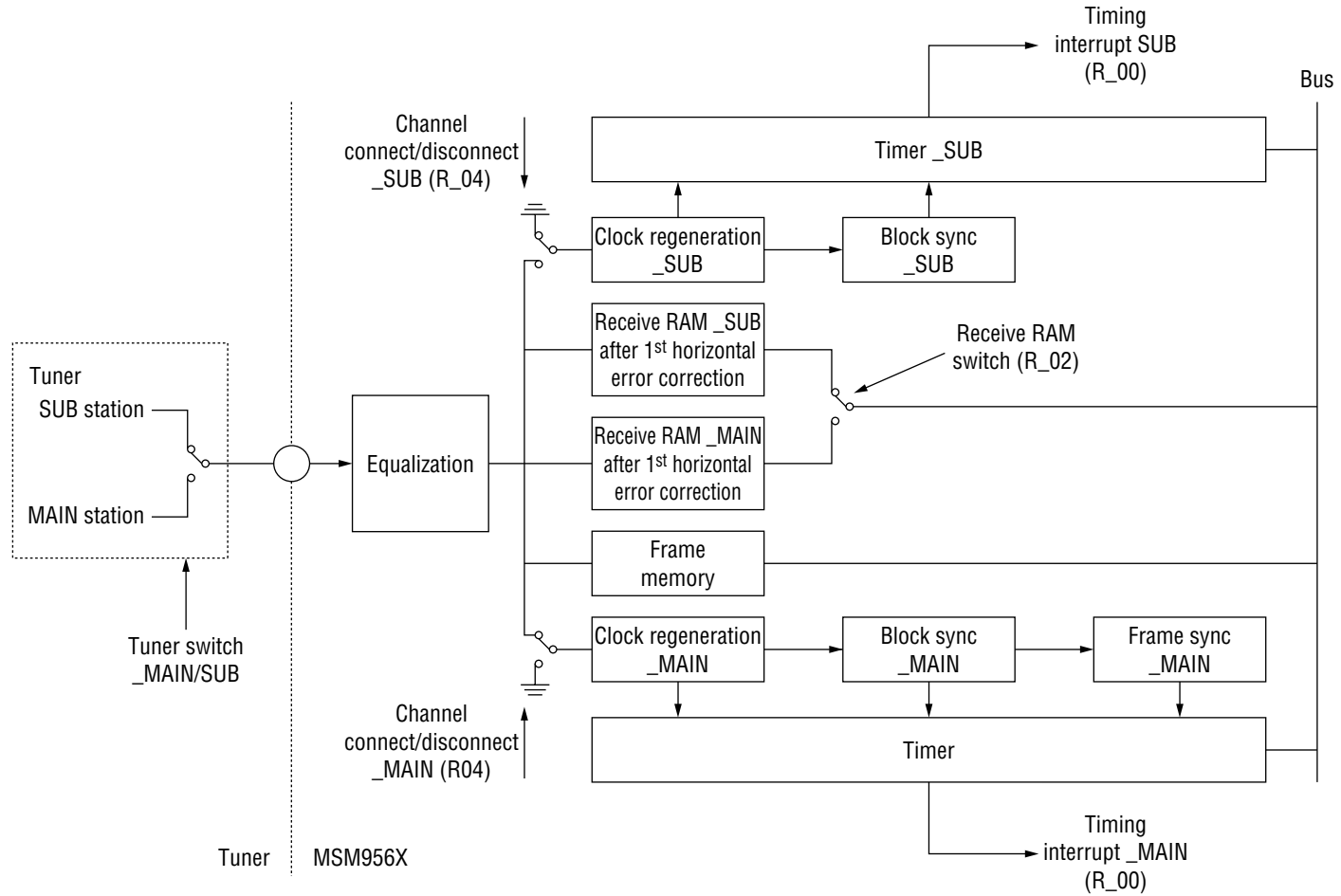

Figure 2.2.1.1. Main/Sub Switched Reception Block Diagram

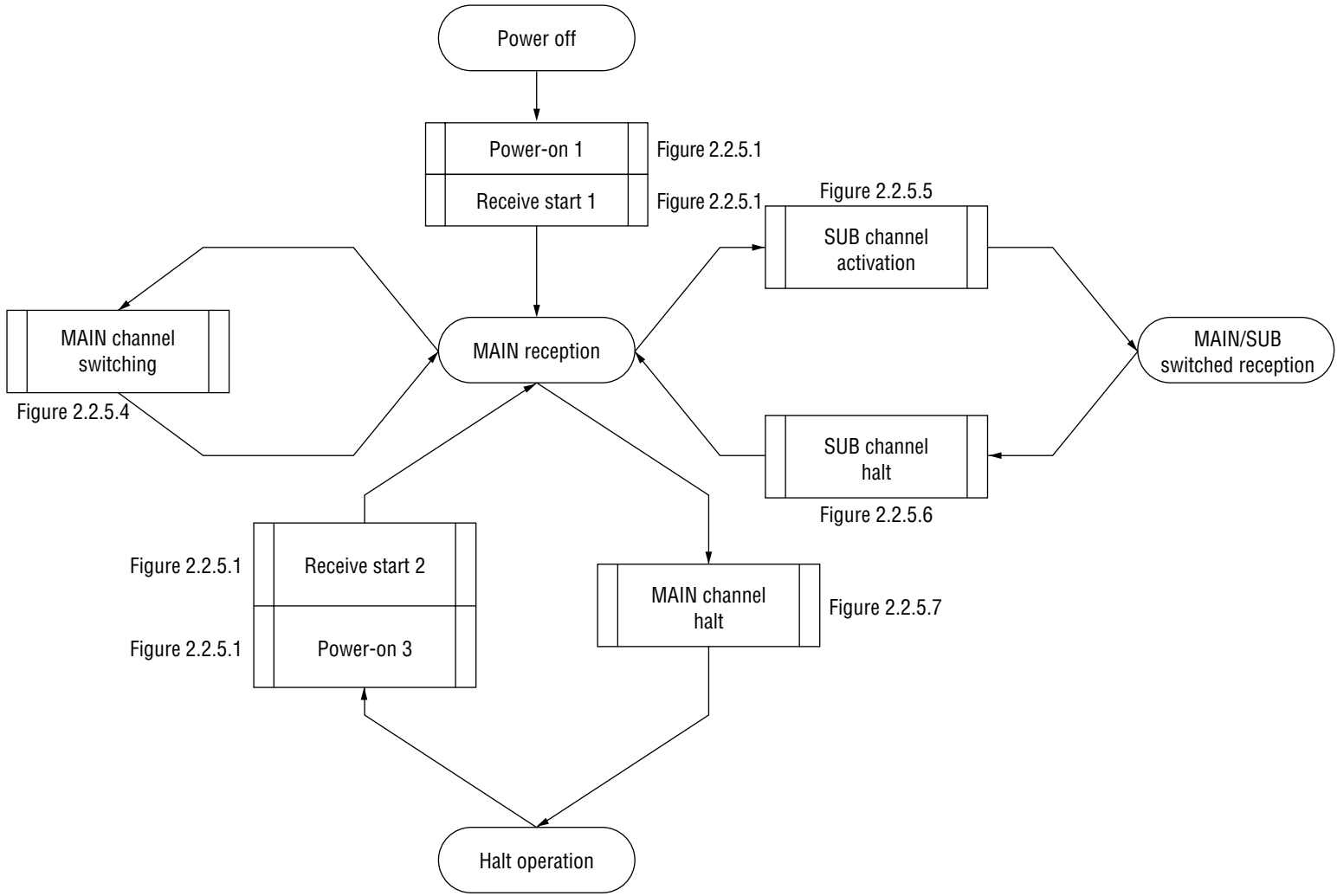

Figure 2.2.1.2 Total Flow

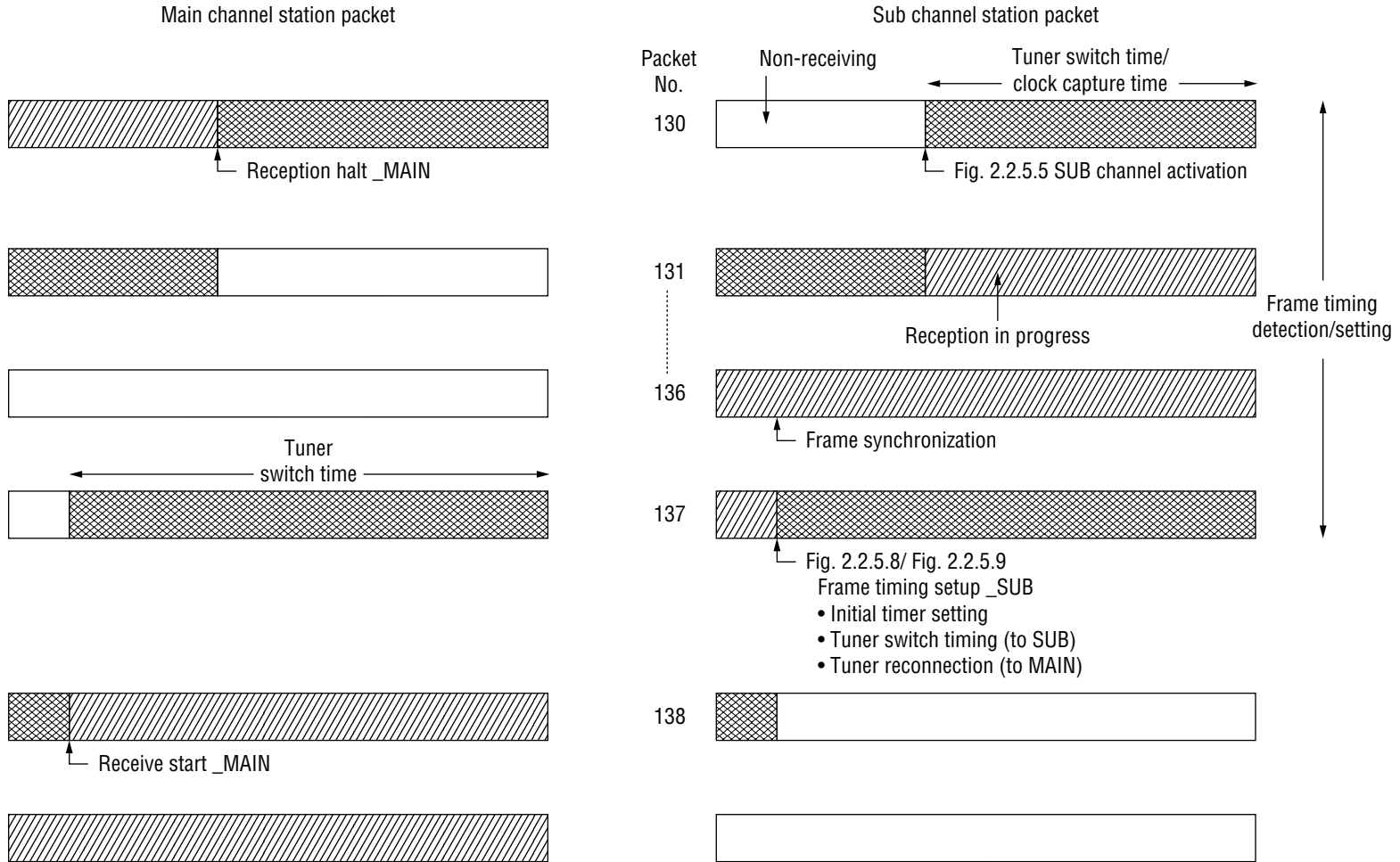

Figure 2.2.1.3-1/2 Main/Sub Switched Reception Timing

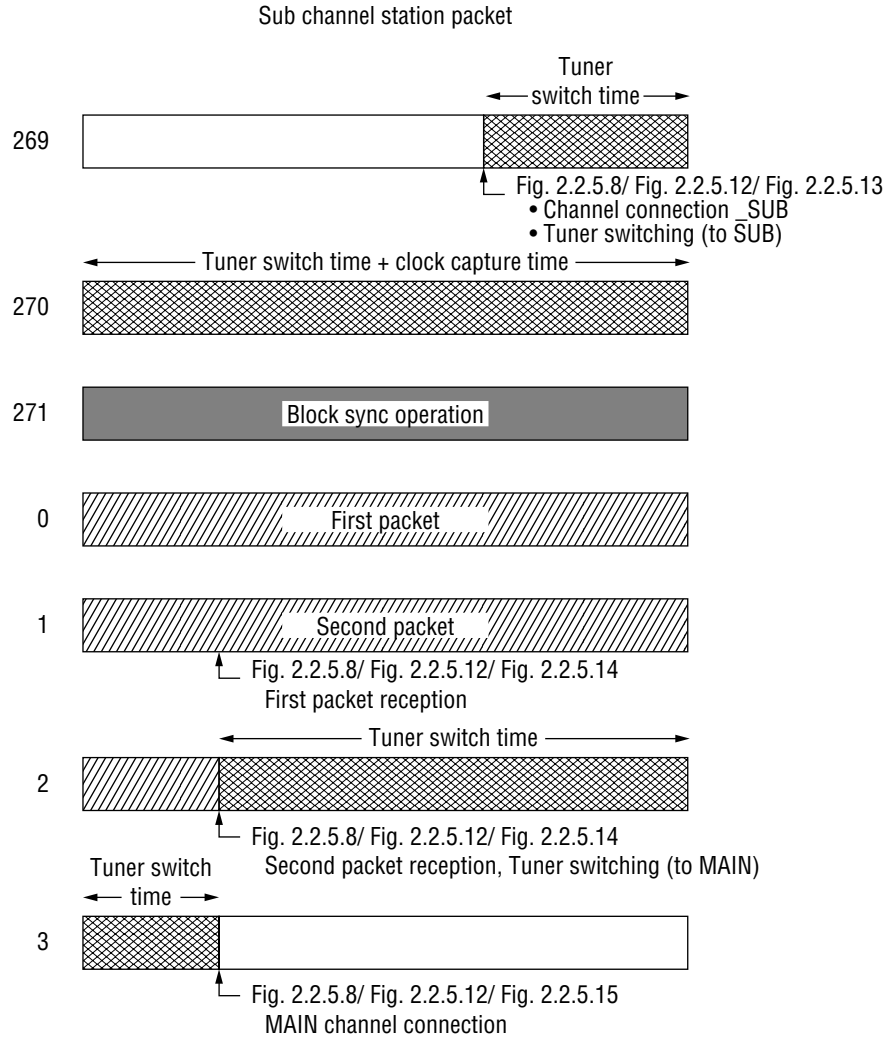
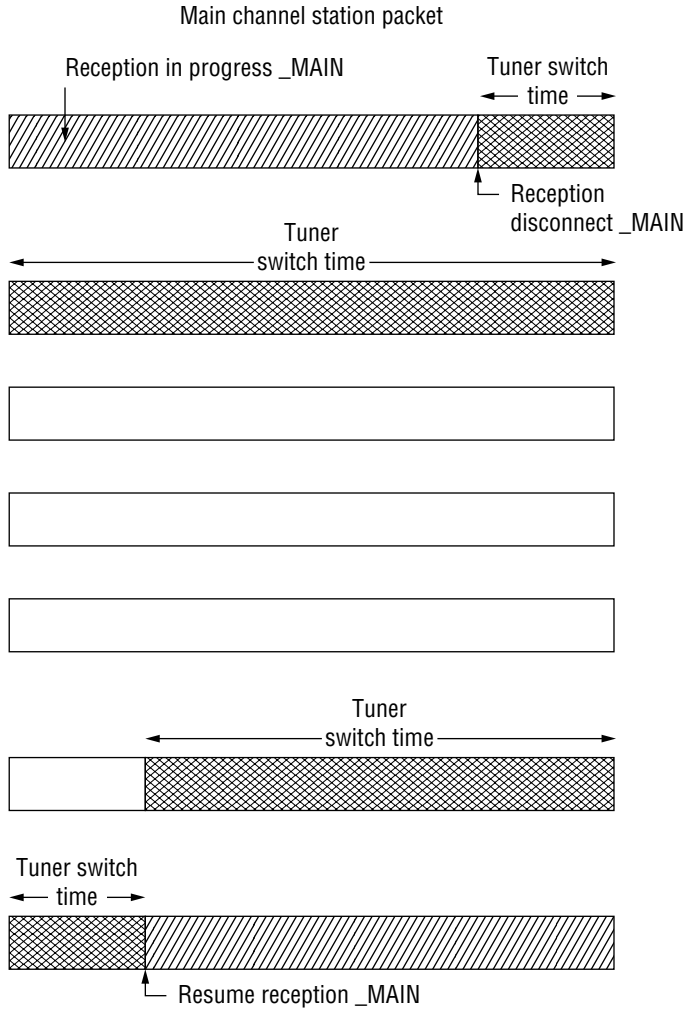

Figure 2.2.1.3-2/2 Main/Sub Switched Reception Timing

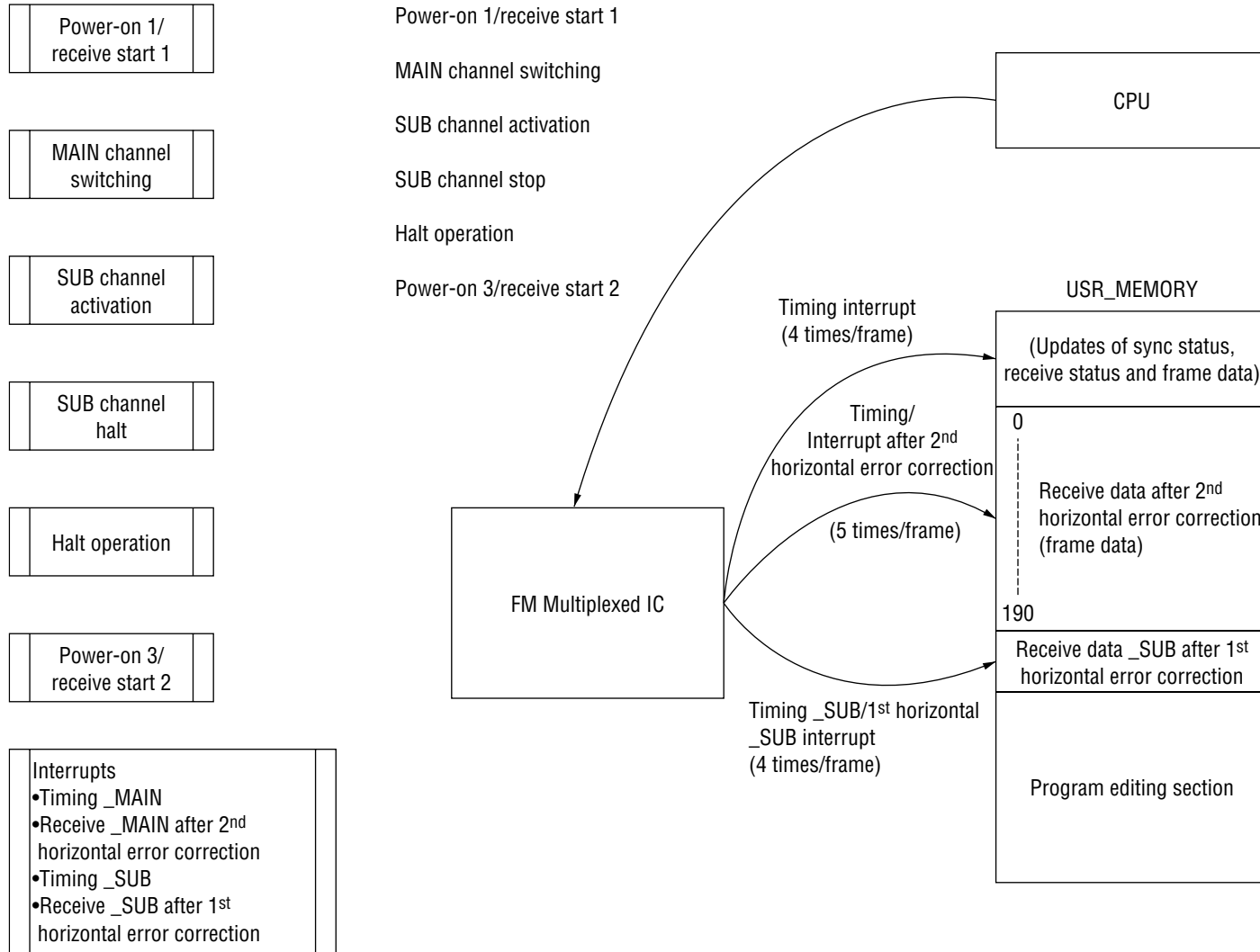

Figure 2.2.2 Total Configuration

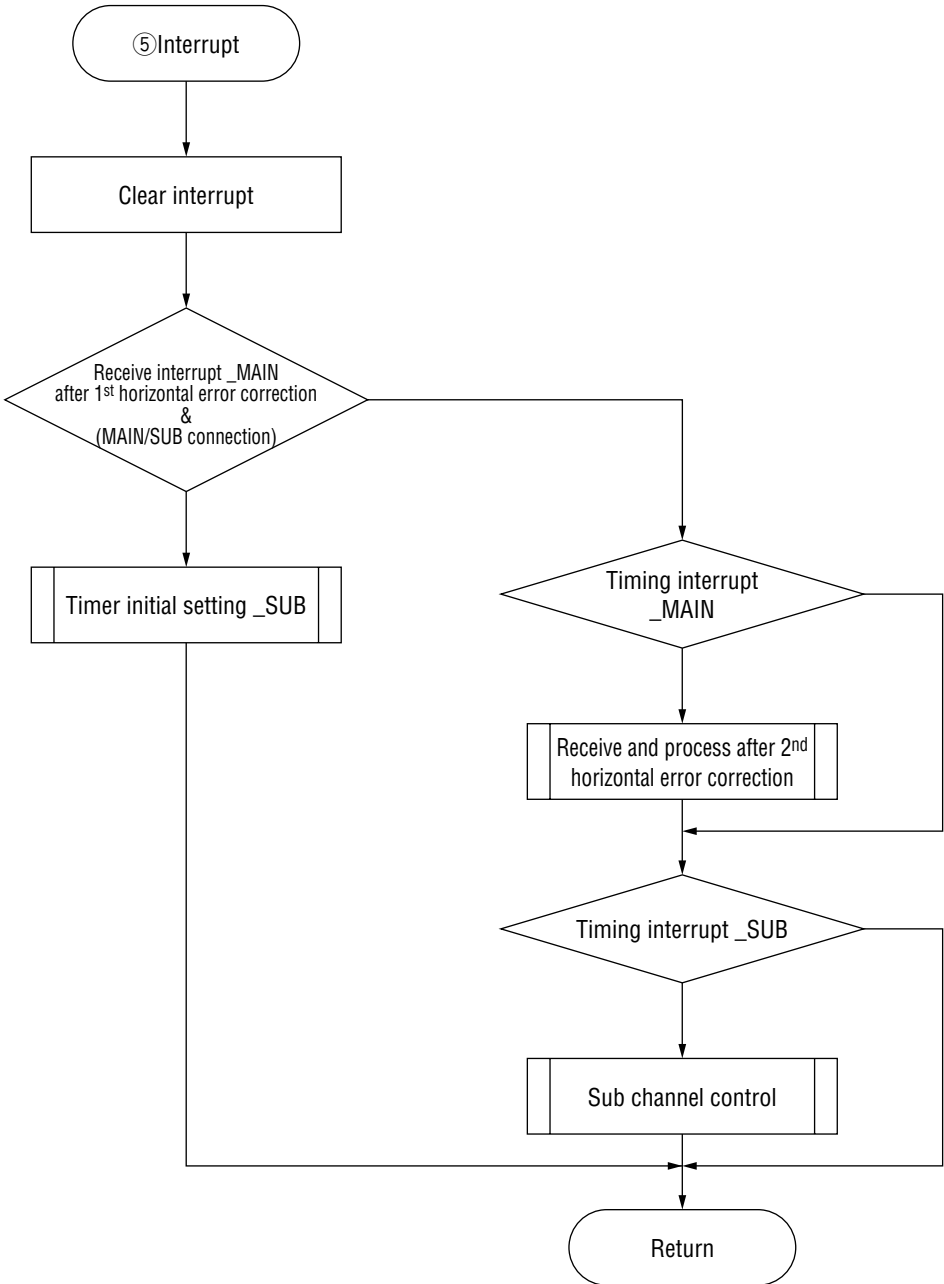

Figure 2.2.3 Simplified Interrupt Flow

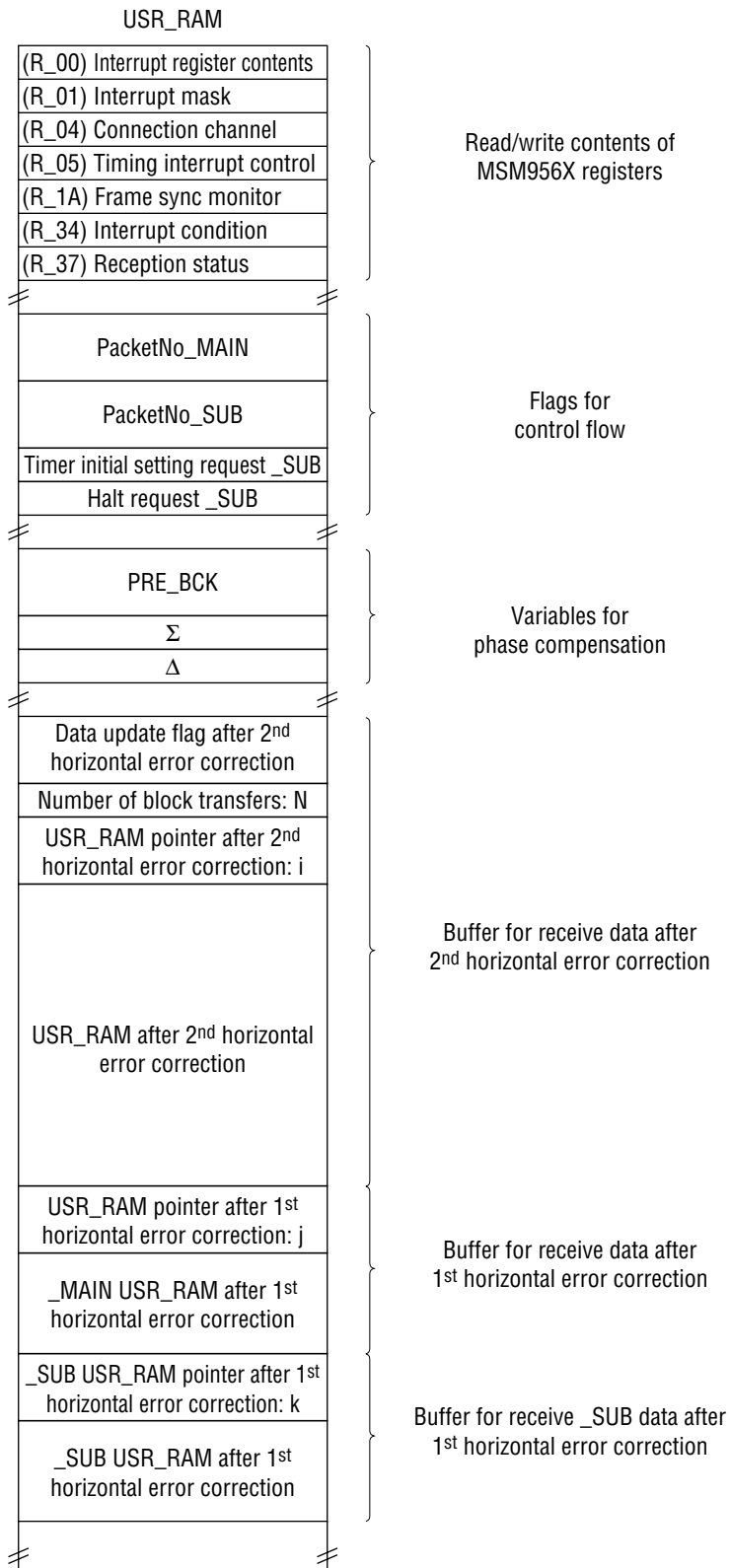

Figure 2.2.4 USR_RAM Configuration

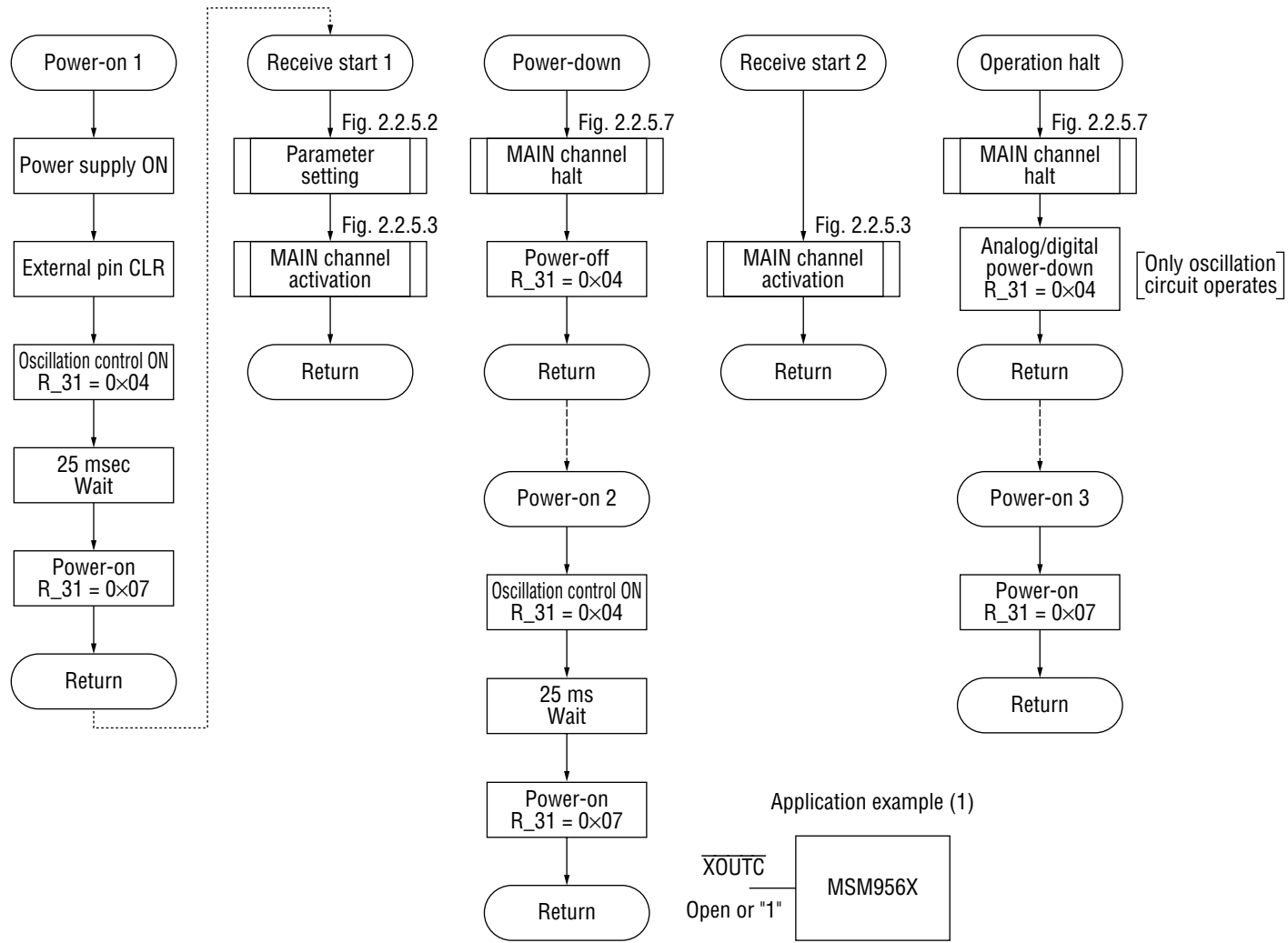

Figure 2.2.5.1 Power-On Control Flow

Table 2.3 Recommended Parameter Setting Values

Register	Address	Setting value	Description
Interrupt mask	0x01	0x36	Receive _MAIN after 1 st horizontal error correction = timing _MAIN = "1" After 2 nd horizontal error correction, setting is unnecessary since receive _MAIN and sync displacement are determined at time of R_00 read.
Integration constant before block synchronization	0x0C	0x06	6
Integration constant after block synchronization	0x0D	0x10	16
Phase correction step	0x0E	0x33	4/4MHz
No. of tolerable BIC errors	0x10	0x09	Before synchronization: 1 After synchronization: 2
No. of protective steps at rear of block synchronization	0x11	0x12	SUB = 1 MAIN = 2
No. of protective steps at front of block synchronization	0x12	0x4F	SUB = 4 MAIN = 15
No. of protective steps at rear of frame synchronization	0x18	0x00	1
No. of protective steps at front of frame synchronization	0x19	0x04	4
DDJ mode *	0x28	0xA0	1 st horizontal error correction/2 nd horizontal error correction mode
Analog	0x30	0x06	DETO_DTST: invalid, ADETIN: invalid Amp gain: ×3, DETTC: invalid
TST1	0x33	0x04	PN decoding: on, Differential decoding: off, Monitor: off

* For MSM9566/67 only

Table 2.4 Registers That Do Not Require Parameter Setting

Register	Address	Initial value	Description
Receive port switching after 1 st horizontal error correction	0x02	0x00	Use initial value of receive _MAIN after 1 st horizontal error correction
Main/sub channel switching	0x04	0x01	Use initial value of main channel (no switching)
Fixed phase adjustment	0x0B	0x00	Setting unnecessary
Clear/set block sync	0x14	0x00	Setting unnecessary
Clear sync	0x1B	0x00	Setting unnecessary
Set sync	0x1C	0x00	Setting unnecessary
Frame format	0x1F	0x02	B format
Error correction	0x20 to 0x22	0x00	Not used
Number of error corrections	0x23	0xFB	Use initial value
Number of error corrections/threshold value	0x25	0xEE	Use initial value
Operating mode	0x3E	0x00	Use initial value

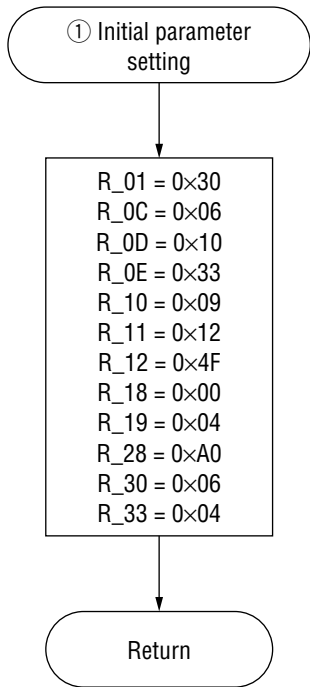

Figure 2.2.5.2
Initial Parameter Setting

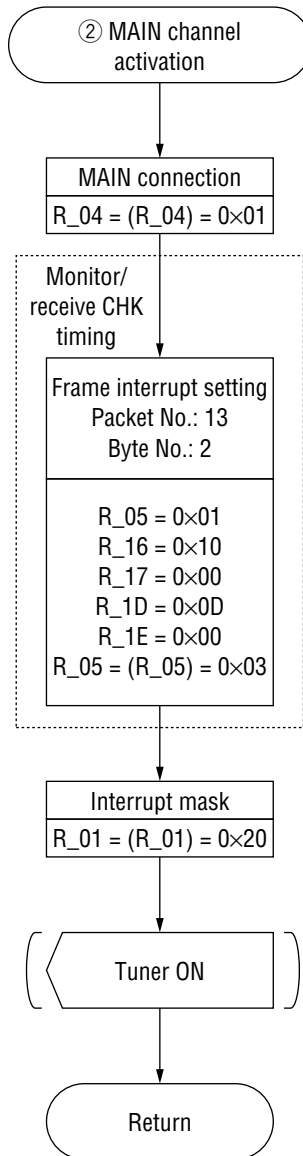

Figure 2.2.5.3
Main Channel Activation

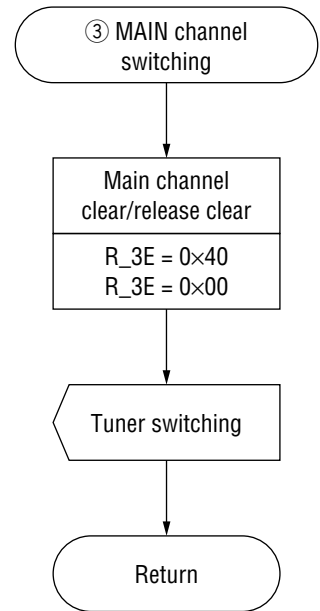

Figure 2.2.5.4
Main Channel Switched
Reception

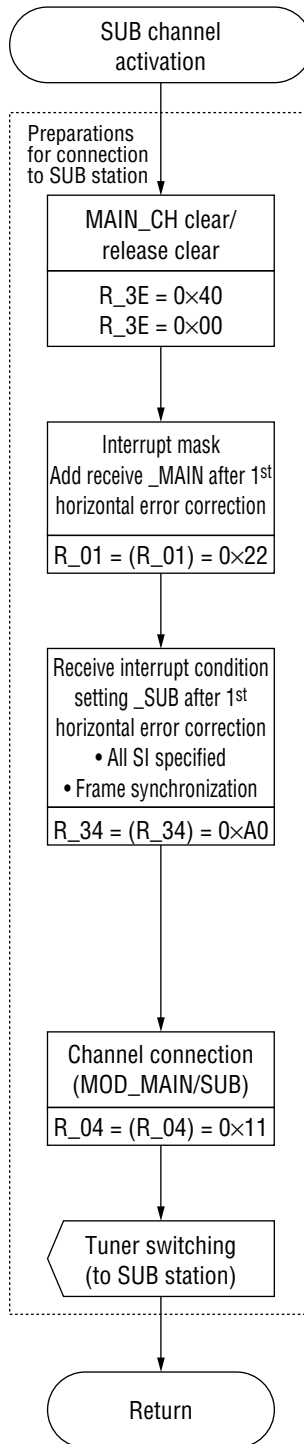

Figure 2.2.5.5 Sub Channel Activation

Activation of SUB Channel Halt

SUB channel reception is halted while maintaining the receive state of the MAIN channel.

(1) In the state where "PacketNo = 269 or 1 or 2", the tuner is connected to the SUB station. Control is performed as follows: ① the MAIN/SUB channel is disconnected, ② the tuner is switched to the MAIN station, and ③ after the tuner switch time elapses, the MAIN channel is reconnected.

Processes ① and ② are executed with the flow shown below on the left. Process ③ is executed within the "figure 2.2.5.15 Main Connection" interrupt routine.

After executing the interrupt of process ③, SUB channel reception is halted.

(2) In the state where "PacketNo != 269 or 1 or 2", the tuner is not connected to the SUB station. Therefore, after the timing interrupt _SUB is halted and the SUB channel is disconnected, SUB channel reception is halted.

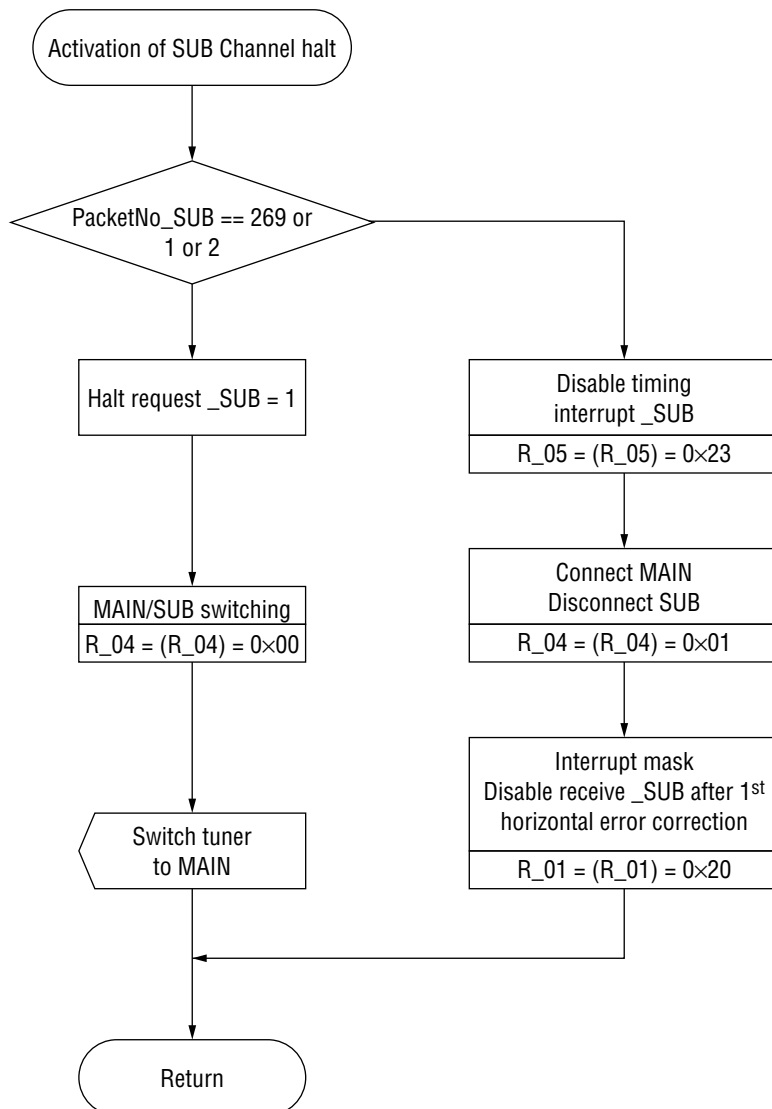

Figure 2.2.5.6 Halting the SUB Channel

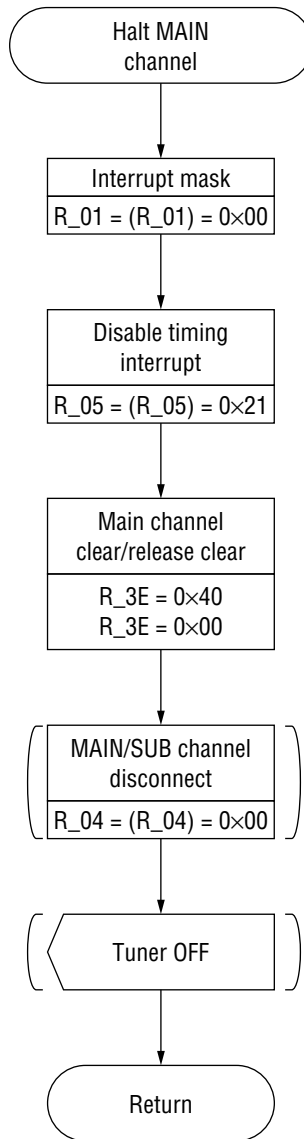

Figure 2.2.5.7 Halting the Main Channel

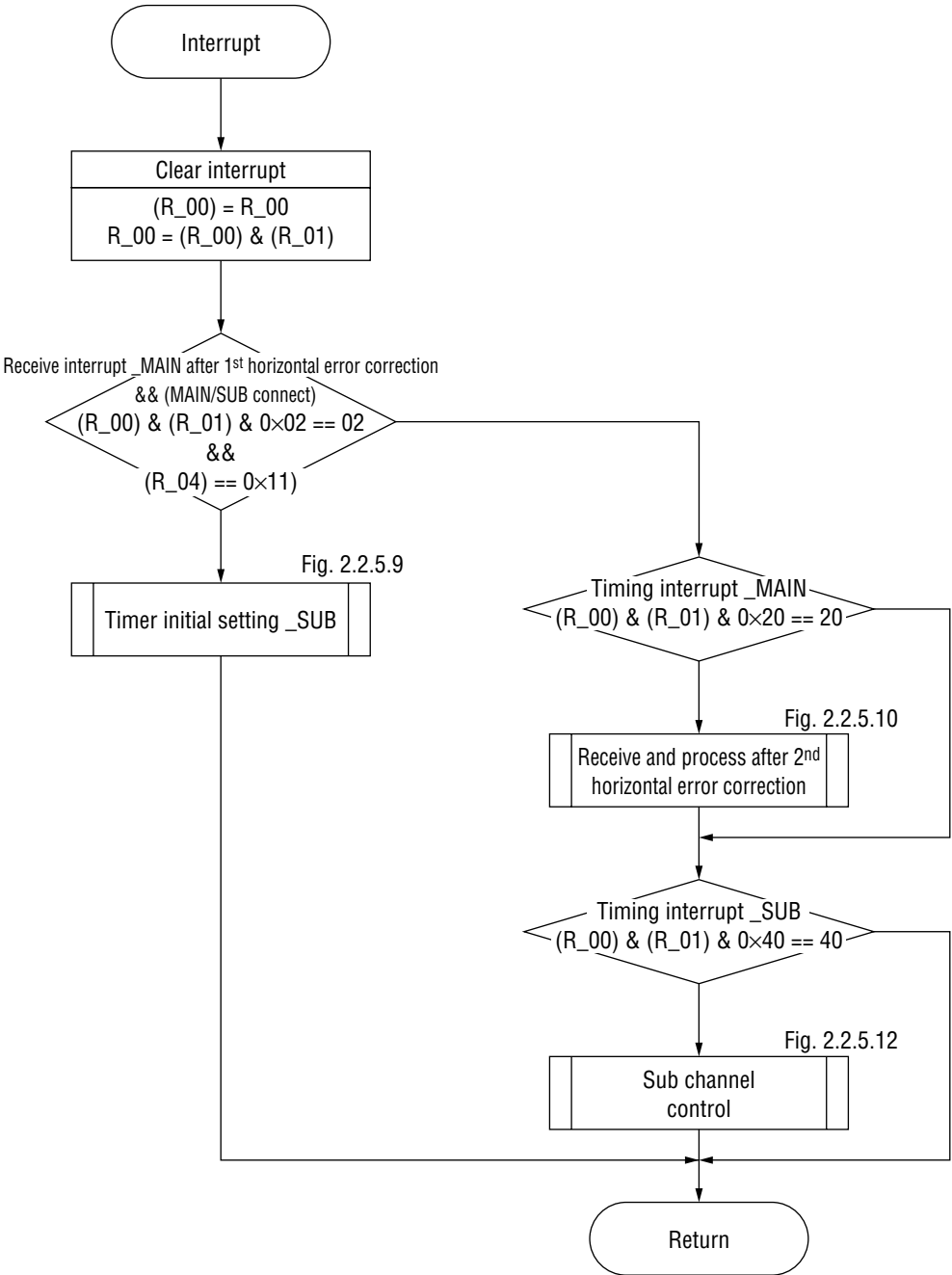

Figure 2.2.5.8 Interrupt Control

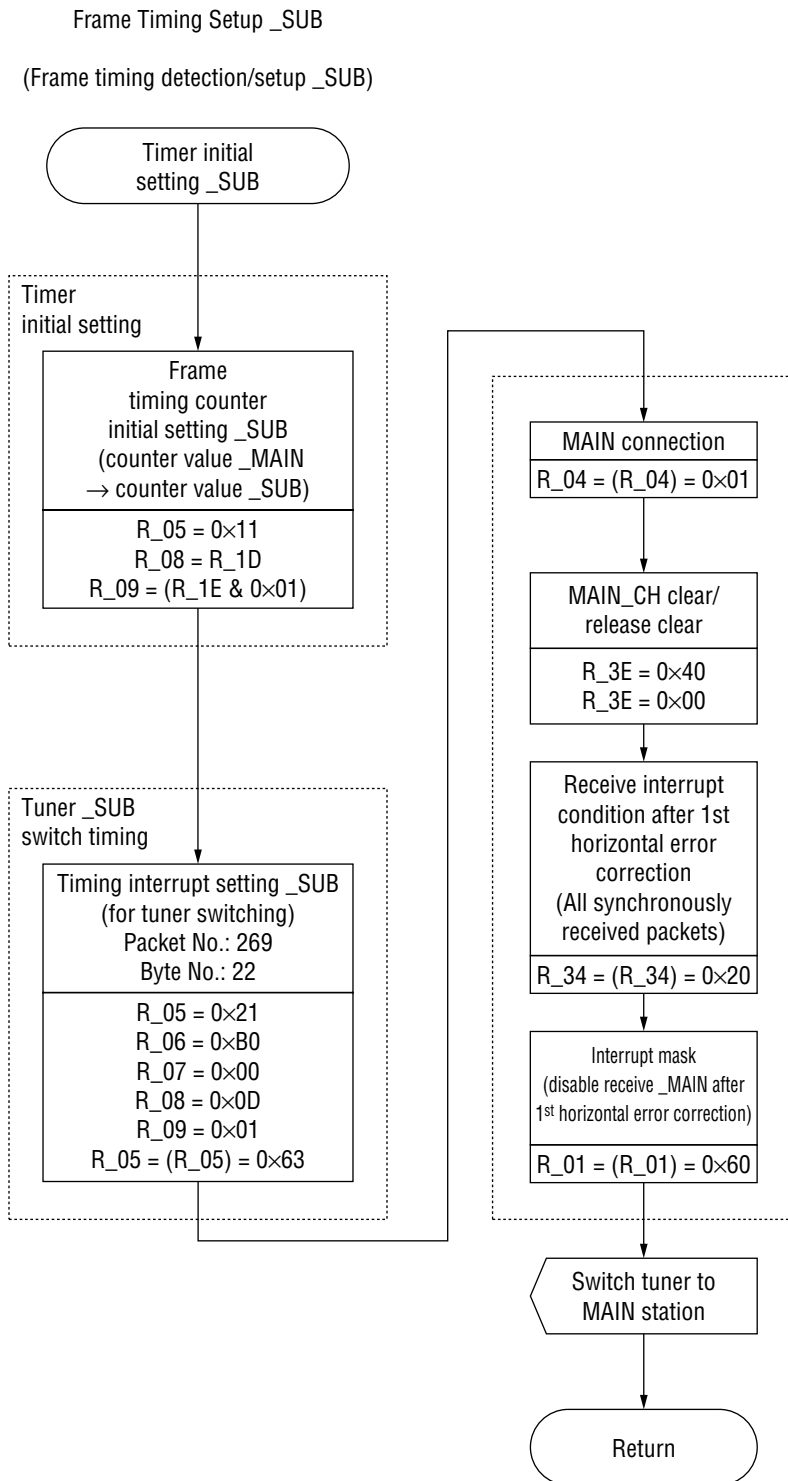

Figure 2.2.5.9 Frame Timing Setup _SUB

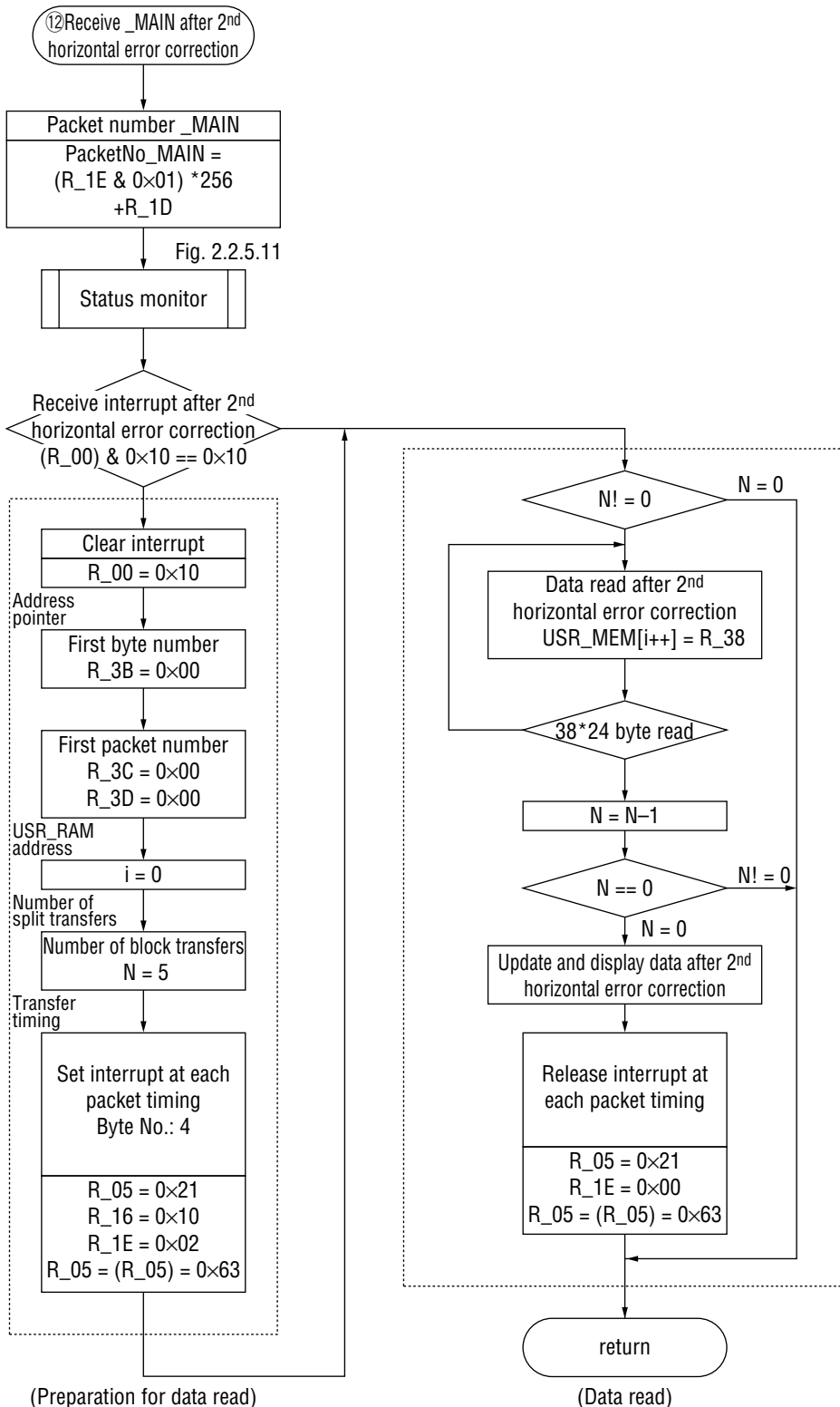

Figure 2.2.5.10 Reception After 2nd Horizontal Error Correction

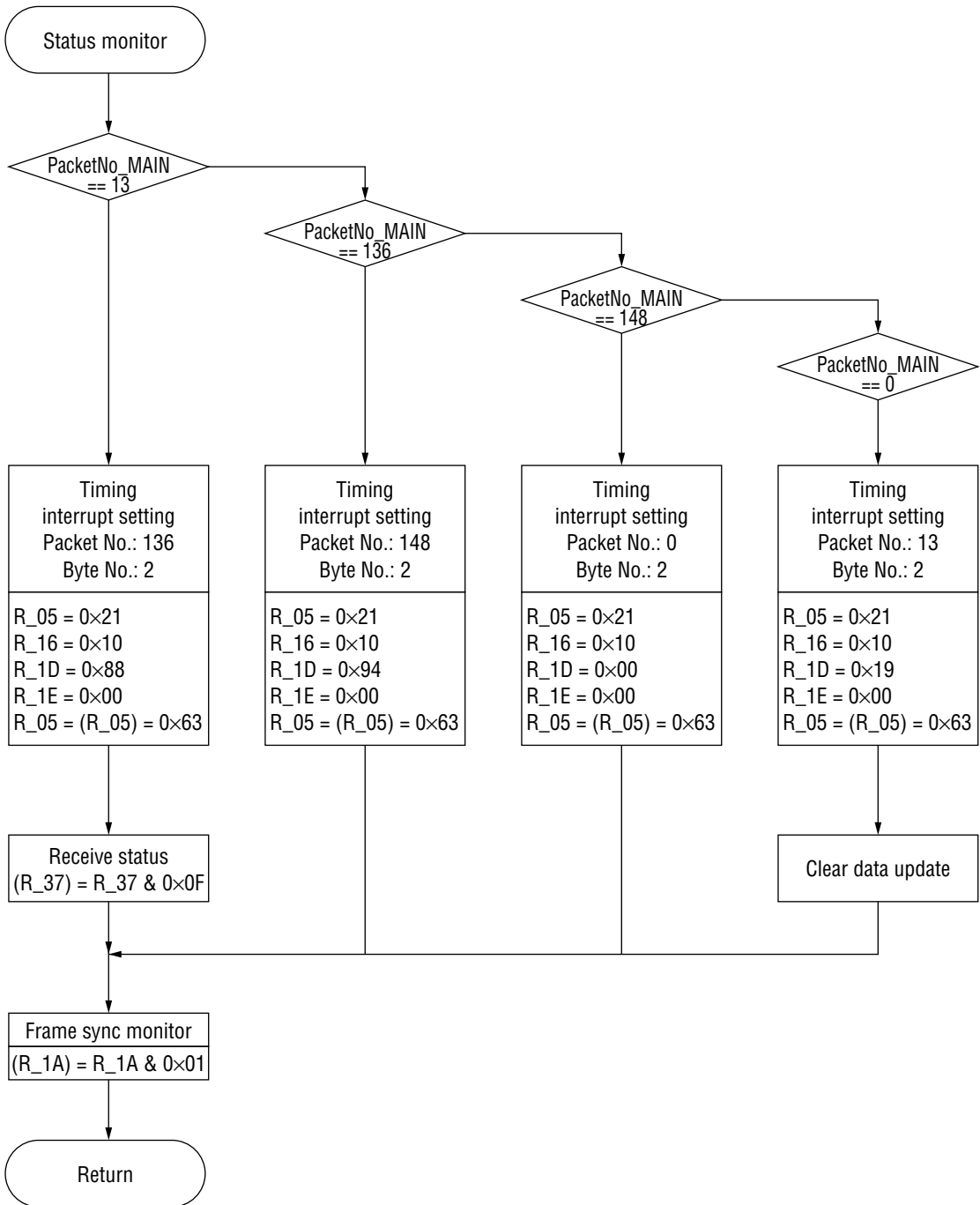

Figure 2.2.5.11 Status Monitor

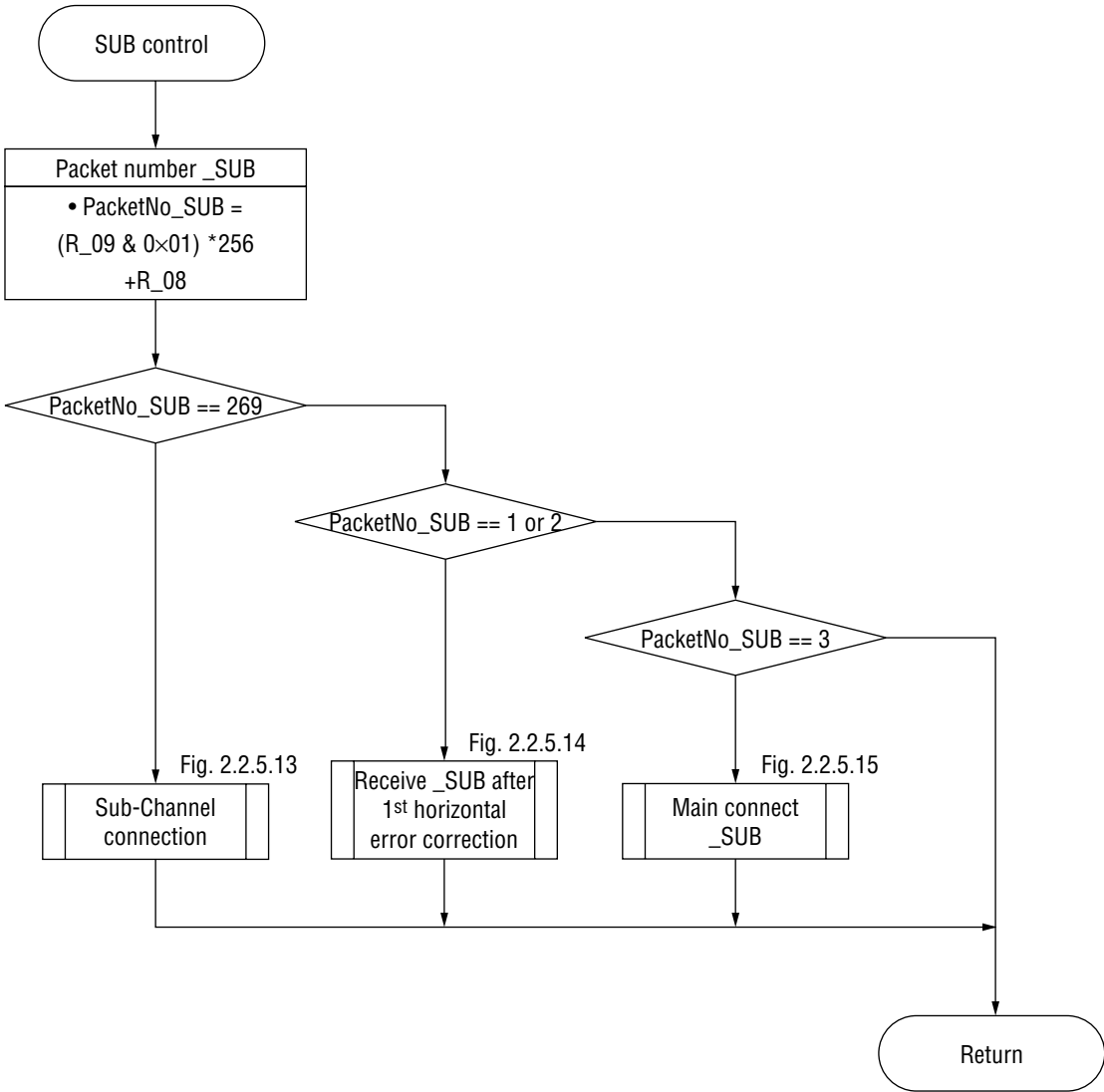

Figure 2.2.5.12 SUB Control

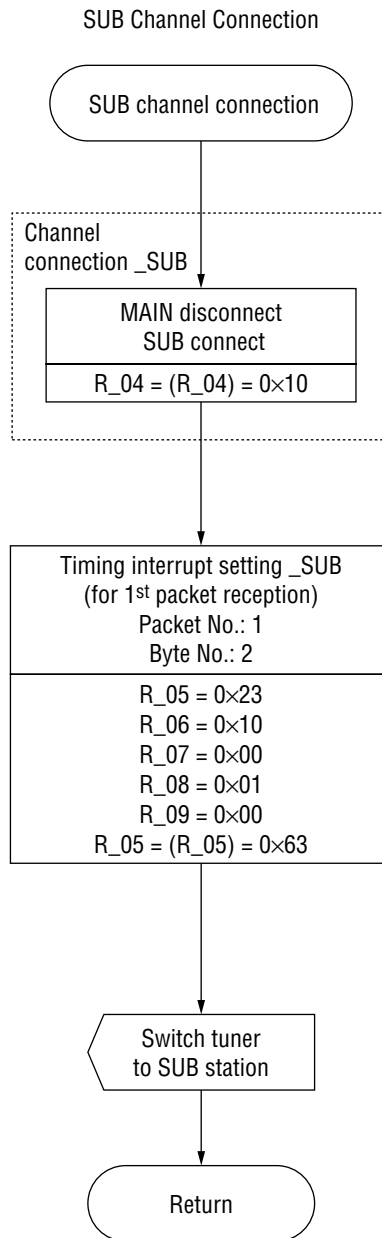

Figure 2.2.5.13 Sub Channel Connection

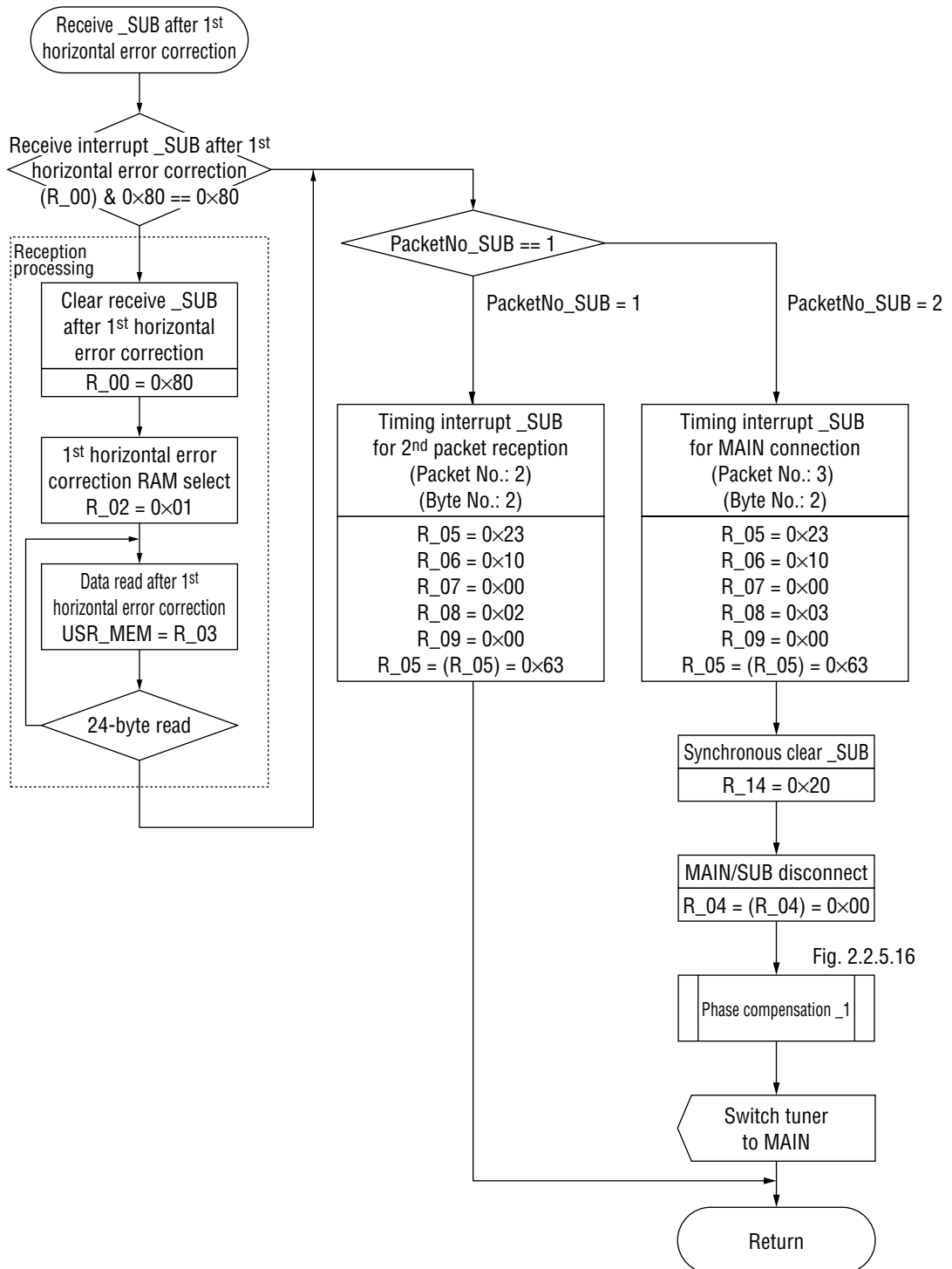

Figure 2.2.5.14 Receive_SUB After 1st Horizontal Error Correction

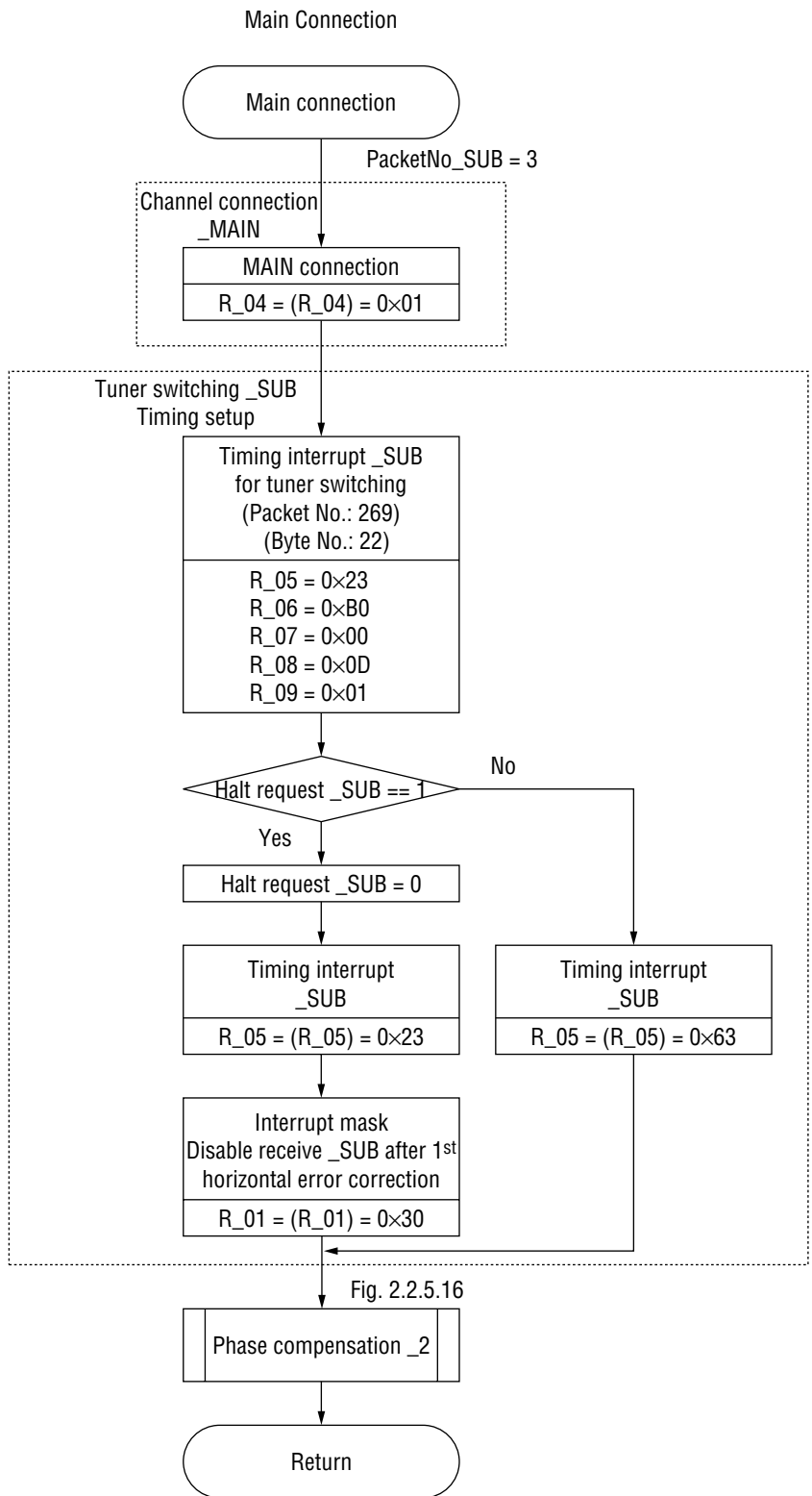

Figure 2.2.5.15 Main Channel Connection

Phase Compensation_SUB

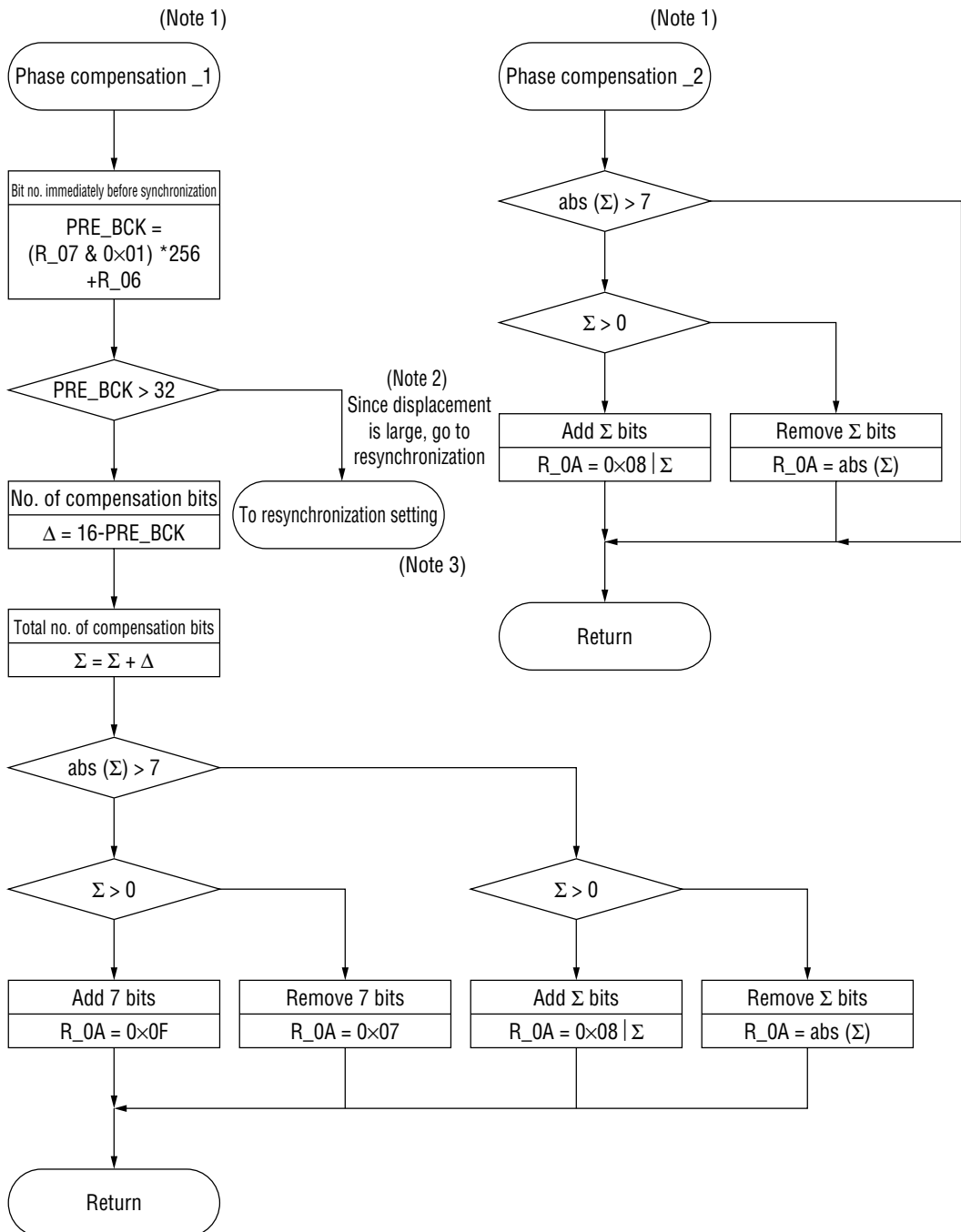

Figure 2.2.5.16 Bit Displacement Compensation

- (Note 1) In this flow, since bit correction of the sub channel is divided and performed in 2 operations, correction of up to ± 14 bits (max.) is possible.
- (Note 2) Correction is necessary 2 or more times.
Alternatively, the packet number may be displaced.
- (Note 3) Implement sub channel activation processing after the sub channel is halted.

