

MITSUBISHI RF POWER MODULE
M67760LC

806-870MHz, 12.5V, 20W, FM MOBILE RADIO

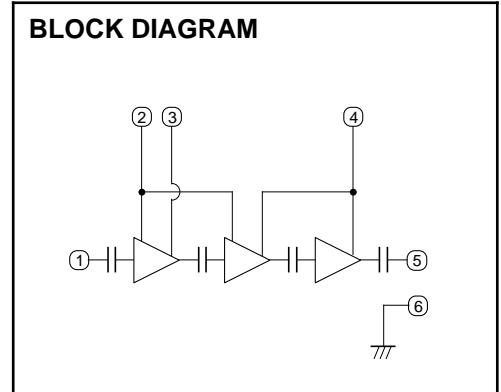
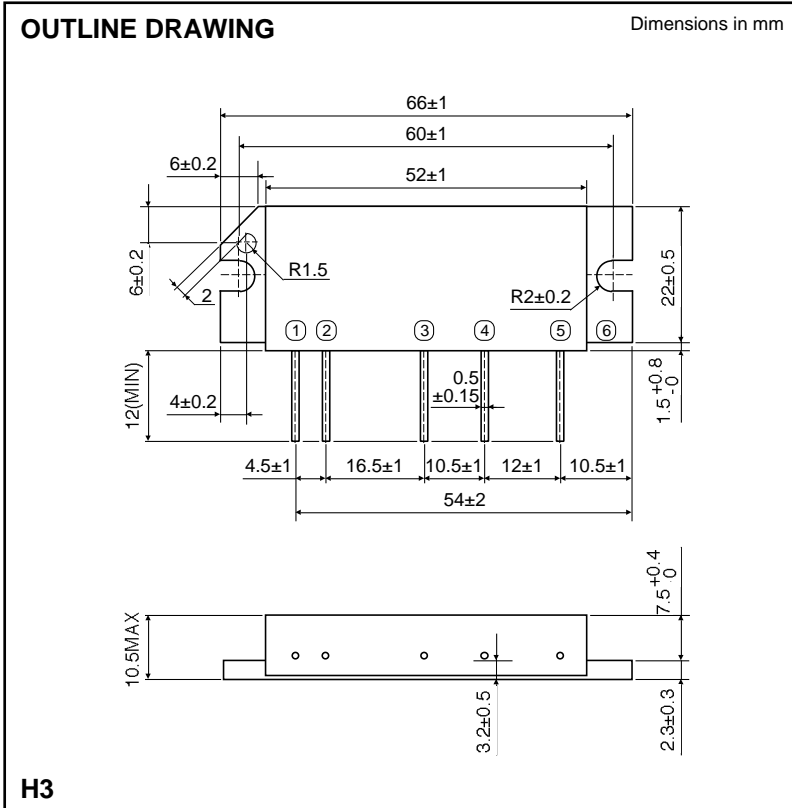

- PIN:
- ① Pin : RF INPUT
 - ② VBB : BASE BIAS SUPPLY
 - ③ VCC1: 1st. DC SUPPLY
 - ④ VCC2: 2nd. DC SUPPLY
 - ⑤ Po : RF OUTPUT
 - ⑥ GND: FIN

ABSOLUTE MAXIMUM RATINGS (T_C=25°C unless otherwise noted)

Symbol	Parameter	Conditions	Ratings	Unit
V _{BB}	Base bias		9.5	V
V _{CC1}	Supply voltage	V _{BB} =9V	14	V
V _{CC2}	Supply voltage	Z _G =Z _L =50 , V _{BB} =9V	16.5	V
I _{CC}	Total current	Z _G =Z _L =50 , V _{CC1} 12.5V	8.5	A
P _{in (max)}	Input power	f=806-870MHz, Z _G =Z _L =50	0.8	W
P _{O (max)}	Output power	Z _G =Z _L =50	25	W
T _{C (OP)}	Operation case temperature	Z _G =Z _L =50	-30 to +110	°C
T _{stg}	Storage temperature		-40 to +110	°C

Note. Above parameters are guaranteed independently.

ELECTRICAL CHARACTERISTICS (T_C=25°C unless otherwise noted)

Symbol	Parameter	Test conditions	Limits		Unit
			Min	Max	
f	Frequency range		806	870	MHz
P _O	Output power	V _{BB} =9V, V _{CC1} =V _{CC2} =12.5V, P _{in} =0.4W, Z _G =Z _L =50	20		W
η	Total efficiency	V _{BB} =9V, V _{CC1} =V _{CC2} =12.5V, Z _G =Z _L =50 , P _O =20W (P _{in} :controlled)	25		%
2f _o	2nd. harmonic			-30	dBc
in	Input VSWR			3	-
-	Load VSWR tolerance	V _{BB} =9V, V _{CC1} =12.5V, V _{CC2} =15.5V, P _O =20W (P _{in} :controlled), Z _G =50 , Load VSWR=20:1 (All phase)	No degradation or destroy		-
-	Stability	V _{BB} =9V, f=806-825, 851-870MHz, V _{CC1} =10 to 12.5V, V _{CC2} =10 to 15.5V (V _{CC1} V _{CC2}), P _O =0 to 20W (P _{in} :controlled less than 0.4W), Z _G =50 , Load VSWR 3:1 (All phase)	No oscillation more than -60dBc		-

Note. Above parameters, ratings, limits and test conditions are subject to change.

TYPICAL PERFORMANCE DATA

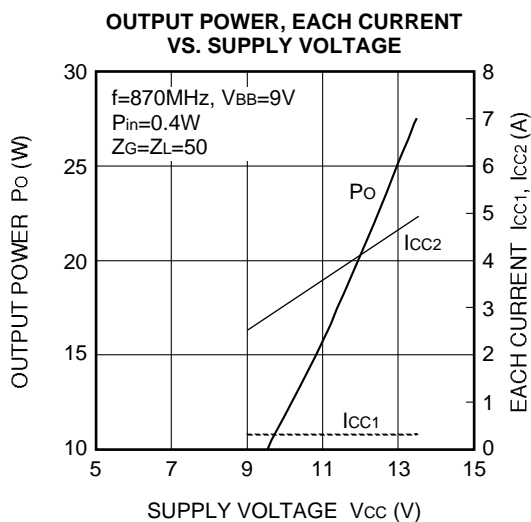
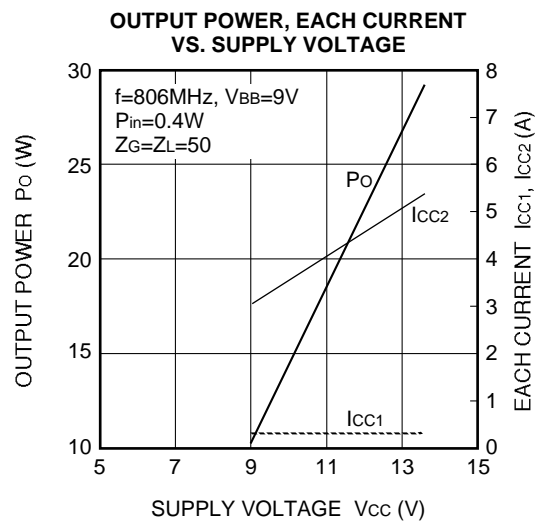
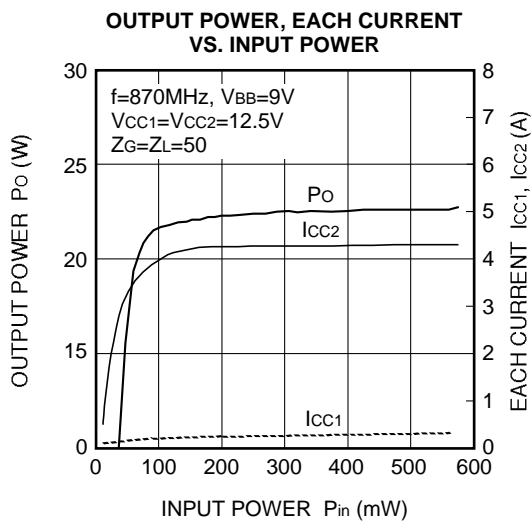
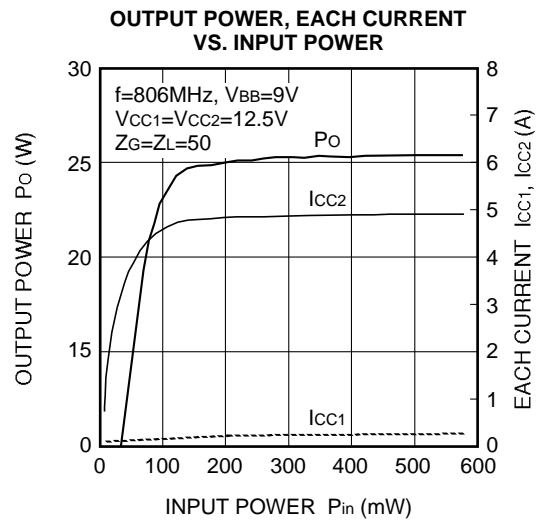
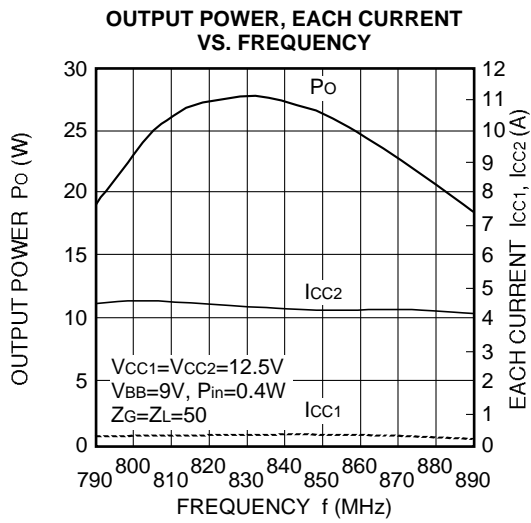

MITSUBISHI RF POWER MODULE
M67760HC

896-941MHz, 12.5V, 20W, FM MOBILE RADIO

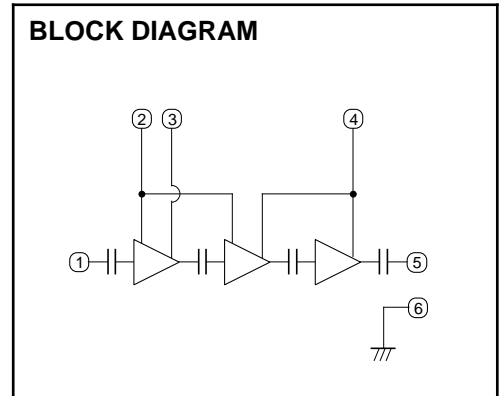
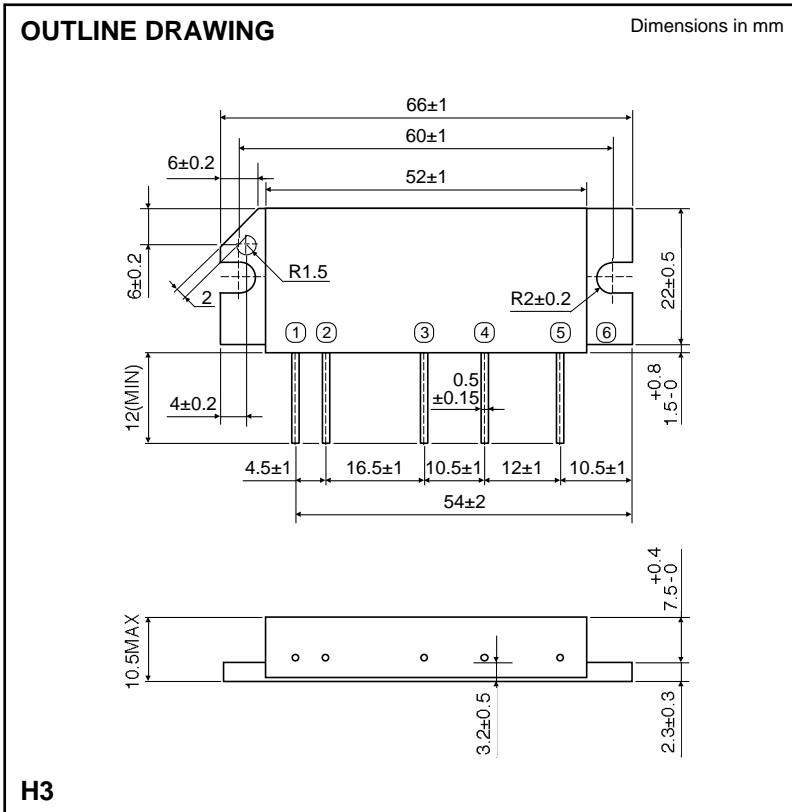

- PIN:
- ① Pin : RF INPUT
 - ② VBB : BASE BIAS SUPPLY
 - ③ VCC1: 1st. DC SUPPLY
 - ④ VCC2: 2nd. DC SUPPLY
 - ⑤ Po : RF OUTPUT
 - ⑥ GND: FIN

ABSOLUTE MAXIMUM RATINGS (T_c=25°C unless otherwise noted)

Symbol	Parameter	Conditions	Ratings	Unit
V _{BB}	Base bias		9.5	V
V _{CC1}	Supply voltage	V _{BB} =9V	14	V
V _{CC2}	Supply voltage	Z _G =Z _L =50 , V _{BB} =9V	16.5	V
I _{CC}	Total current	Z _G =Z _L =50 , V _{CC1} 12.5V	8.5	A
P _{in (max)}	Input power	f=896-941MHz, Z _G =Z _L =50	0.8	W
P _{O (max)}	Output power	Z _G =Z _L =50	25	W
T _{c (OP)}	Operation case temperature	Z _G =Z _L =50	-30 to +110	°C
T _{stg}	Storage temperature		-40 to +110	°C

Note. Above parameters are guaranteed independently.

ELECTRICAL CHARACTERISTICS (T_c=25°C unless otherwise noted)

Symbol	Parameter	Test conditions	Limits		Unit
			Min	Max	
f	Frequency range		896	941	MHz
P _O	Output power	V _{BB} =9V, V _{CC1} =V _{CC2} =12.5V, P _{in} =0.4W, Z _G =Z _L =50	20		W
η	Total efficiency	V _{BB} =9V, V _{CC1} =V _{CC2} =12.5V, Z _G =Z _L =50	25		%
2f _o	2nd. harmonic	P _O =20W (P _{in} :controlled)		-30	dBc
in	Input VSWR			3	-
-	Load VSWR tolerance	V _{BB} =9V, V _{CC1} =12.5V, V _{CC2} =15.5V, P _O =20W (P _{in} :controlled), Z _G =50 , Load VSWR=20:1	No degradation or destroy		-
-	Stability	V _{BB} =9V, f=896-902, 935-941MHz, V _{CC1} =10 to 12.5V, V _{CC2} =10 to 15.5V (V _{CC1} V _{CC2}), P _O =0 to 20W (P _{in} :controlled less than 0.4W), Z _G =50 , Load VSWR 3:1 (All phase)	No oscillation more than -60dBc		-

Note. Above parameters, ratings, limits and test conditions are subject to change.

MITSUBISHI RF POWER MODULE
M67760HC

896-941MHz, 12.5V, 20W, FM MOBILE RADIO

TYPICAL PERFORMANCE DATA

OUTPUT POWER, TOTAL EFFICIENCY VS. FREQUENCY

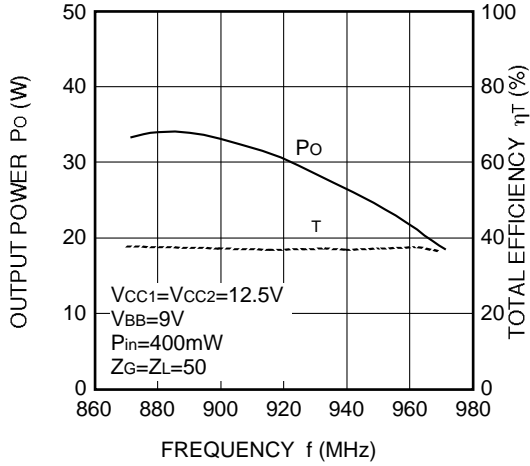

OUTPUT POWER, VS. INPUT POWER

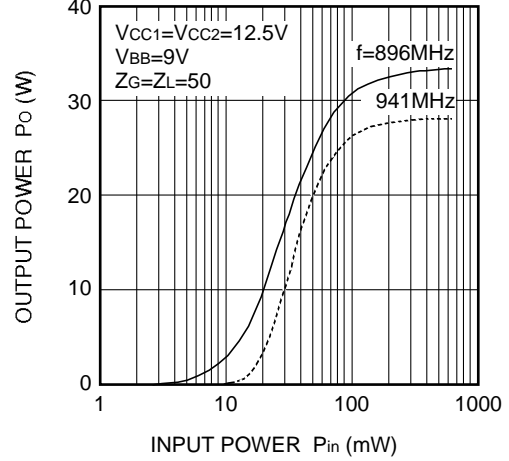

OUTPUT POWER, EACH CURRENT VS. 1st. SUPPLY VOLTAGE

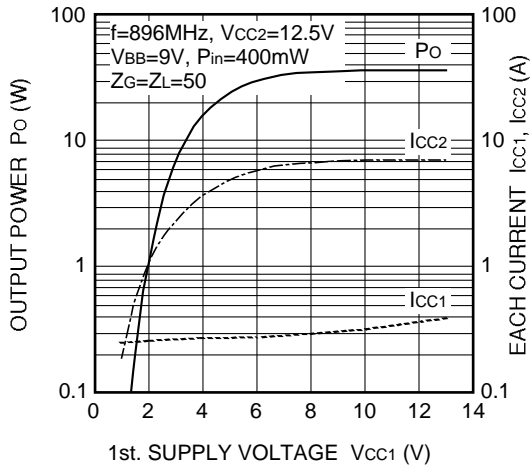

OUTPUT POWER, EACH CURRENT VS. 1st. SUPPLY VOLTAGE

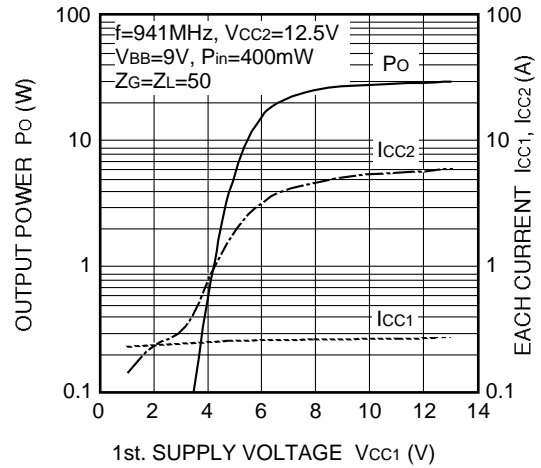

OUTPUT POWER, EACH CURRENT VS. SUPPLY VOLTAGE

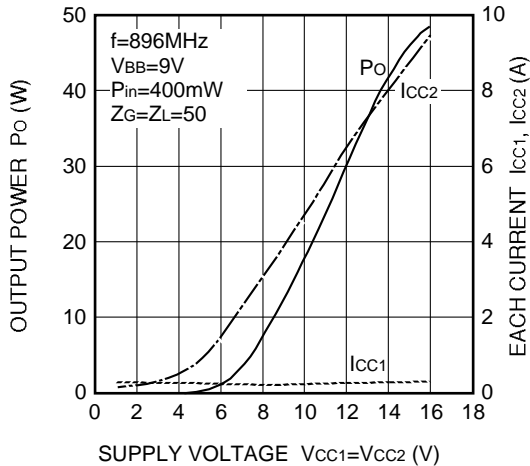

OUTPUT POWER, EACH CURRENT VS. SUPPLY VOLTAGE

