

**SANYO**

No.1304B

**LA1247**Monolithic Linear IC  
AM Electronic Tuner

The LA1247 is a high-performance IC developed for AM electronic tuning systems. It performs all the functions needed for AM tuner systems and also provides auto search stop signal, local oscillation buffer output, low-level local oscillation. Moreover, the local oscillation is stable from LW to SW, facilitating multiband applications.

**Functions**

- RF amplification
- OSC (with ALC)
- Detection
- Signal meter drive output (also used as auto search stop signal)
- Others
- MIX
- IF amplification
- AGC
- Local oscillation buffer output

**Features**

- |                                     |  |
|-------------------------------------|--|
| 1. Narrow-band signal meter:        | Usable as auto search stop signal (possible to make wide-band)<br>Signal meter output 1/2 frequency $\pm 1.5$ kHz typ.                 |
| 2. Local oscillation buffer output: | Easy to design electronic tuning frequency display   |
| 3. LSC (with ALC):                  | Stabilized oscillation output for varactor diode and improved tracking error   |
| 4. RF amplification:                | Excellent usable sensitivity (45 dB/m typ.) due to low noise transistor cascode connection   |
| 5. MIX:                             | Highly resistant to spurious interference, IF interference due to double balanced type differential MIX (IF interference = 85 dB typ.) |
| 6. Low noise:                       | Good S/N (57 dB typ.) for medium input   |
| 7. VCC variation compensation:      | Little variation in gain, distortion, etc. (8 to 16 V)   |
| 8. Pop noise reduction:             | Possible to reduce pop noise at the time of VCC-on, mode-on by selecting AGC time constant   |
| 9. Meeting AM stereo requirements:  | Subchannel S/N is more improved as compared with the LA1245.   |

Information furnished by SANYO is believed to be accurate and reliable. However, no responsibility is assumed by SANYO for its use, nor for any infringements of patents or other rights of third parties which may result from its use, and no license is granted by implication or otherwise, under any patent or patent rights of SANYO.

Case Outline 3021B-D20SIC  
(unit:mm)

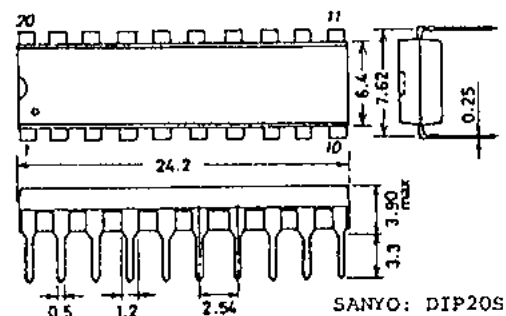

Specifications and information herein are subject to change without notice.

**SANYO Electric Co., Ltd. Semiconductor Overseas Marketing Div.**  
Natsume Bldg., 18-6, 2-chome, Yushima, Bunkyo-ku, TOKYO 113 JAPAN

8029TA/2126KI/8044KI/6233KI, TS 秀 No.1304-1/11

**Maximum Ratings at  $T_a = 25^\circ\text{C}$** 

				unit
Supply voltage	$V_{CC}$ max	Pin 8, 14	16	V
Output voltage	$V_O$	Pin 5, 7	24	V
Input voltage	$V_I$	Pin 3	5.6	V
Supply current	$I_{CC}$ max	Pin 5 + 7 + 8 + 14	32	mA
Output high drive current	$I_{18}$	Pin 18	5	mA
	$I_{20}$	Pin 20	2	mA
Allowable power dissipation	$P_D$ max	See Fig. 2	700	mW
Operating temperature	$T_{opg}$		$-20 \sim +70$	$^\circ\text{C}$
Storage temperature	$T_{stg}$		$-40 \sim +125$	$^\circ\text{C}$

**Recommended Operating Condition at  $T_a = 25^\circ\text{C}$** 

				unit
Recommended supply voltage	$V_{CC}$		12	V
Operating voltage range	$V_{CC}$		8 ~ 16	V

**Operating Characteristics at  $T_a = 25^\circ\text{C}$ ,  $V_{CC} = 12\text{ V}$ ,  $f_r = 1\text{ MHz}$ ,  $f_m = 400\text{ Hz}$ , at specified test circuit (based on application circuit).**

			min	typ	max	unit
Current dissipation	$I_{CC}$ (1)	quiescent	16.0	25.0	35.0	mA
	$I_{CC}$ (2)	with 107 dB $\mu$ input	19.0	29.0	40.0	mA
Detection output	$V_O$ (1)	with 23 dB $\mu$ input, mod. 30 %	-27.5	-23.0	-18.5	dBm
	$V_O$ (2)	with 80 dB $\mu$ input, mod. 30 %	-15.5	-12.5	-9.5	dBm
Signal to noise ratio	S/N (1)	with 23 dB $\mu$ input, mod. 30 %	16	20		dB
	S/N (2)	with 80 dB $\mu$ input, mod. 30 %	52	57		dB
Total harmonic distortion	THD (1)	with 80 dB $\mu$ input, mod. 30 %		0.4	1.0	%
	THD (2)	with 107 dB $\mu$ input, mod. 30 %		0.3	1.0	%
Signal meter output	VSM (1)	quiescent		0	0.5	V
	VSM (3)	with 107 dB $\mu$ input	3.5	5.0	7.0	V
Input at signal meter output = 1 V	$V_{IN}$ (1)	VSM output 1V	20.0	26.0	32.0	dB $\mu$
Local oscillation-buffer output	$V_{osc}$		380	530		mVrms

**Reference Characteristics**

			typ	unit
Signal meter output	VSM (2)	with 40 dB $\mu$ input	2.5	V
Total harmonic distortion	THD (3)	with 112 dB $\mu$ input, mod. 30 %	2	%
Local oscillation fluctuation within a band	$\Delta V_{osc}$	from $V_{oscL}$ (522 kHz) to $V_{oscH}$ (1647 kHz)	10	mVrms
Signal meter band width*	VSM-BW1	with 80 dB $\mu$ input, 1/2 output frequency	$\pm 1.5$	kHz
	VSM-BW2	with 80 dB $\mu$ input, 1/10 output frequency	-4.5/+7	kHz
Selectivity		$\pm 10\text{ kHz}$ at 30 % mod.	45	dB
IF Interference		$f_r = 600\text{ kHz}$	85	dB
Image frequency interference ratio		$f_r = 1400\text{ kHz}$	40	dB
AM stereo subchannel	S/N	Subchannel S	50	dB

\* BFB450C4 N (MURATA, JAPAN) was used as a narrow band filter.

(note) 0 dBm = 775 mV, 0 dB $\mu$  = 1  $\mu$ V.

Using the automatic search-stop signal

Signal Meter-driving output is equivalent to Fig.1, signal meter driving output (abbreviated as V<sub>SM</sub>) is narrowed in band width and can be used as an automatic search-stop signal when a narrow band series resonator is connected to pin 15. V<sub>SM</sub> can be adjusted with R<sub>208</sub> and R<sub>211</sub> both in wide band and narrow band since R<sub>208</sub> is inversely proportional to V<sub>SM</sub>, while R<sub>211</sub> is proportional to V<sub>SM</sub>. R<sub>208</sub> is related to the Q of narrow band signal meter. When the resistance of R<sub>208</sub> is increased, the Q will be damped and the band width increased. On the other hand, R<sub>211</sub> used as the output impedance of V<sub>SM</sub> and affects the cut-off frequency and time constant of low pass filter for V<sub>SM</sub> and the meter drive impedance. The time constant and the cut-off frequency f<sub>c</sub> can be expressed as follows:

$$\tau = (C_{114} + C_{115} + C_s) \times (R_{211} / R_{in})$$

$$f_c = \frac{1}{2\pi\tau}$$

A semi-fixed resistor is recommended to be used as R<sub>211</sub> to allow the fluctuation of V<sub>SM</sub>. Refer to Fig. 3 for the value of the semi-fixed resistor since this depends upon V<sub>SM</sub> and R<sub>208</sub>. Fig. 3 shows the lowest limit of the semi-fixed resistor in relation to R<sub>208</sub> with the parameter of V<sub>SM</sub> set point the value of the semi-fixed resistor will be equal to or greater than that shown in Fig. 3. For example, when V<sub>SM</sub> = 5 V and R<sub>208</sub> = 240 ohm, R<sub>211</sub> becomes 28 kohm. Thus, the value of the semi-fixed resistor is determined to be about 30 kohm. When the value of V<sub>SM</sub> is too large, it is limited and saturated to the source voltage so it is recommended to follow the condition of V<sub>SM</sub> ≤ V<sub>CC</sub> - 2 (V). When a narrow band serial resonator is used, include the resonant impedance to determine the value of R<sub>208</sub>.

Fig. 1 Signal Meter Detector Circuit

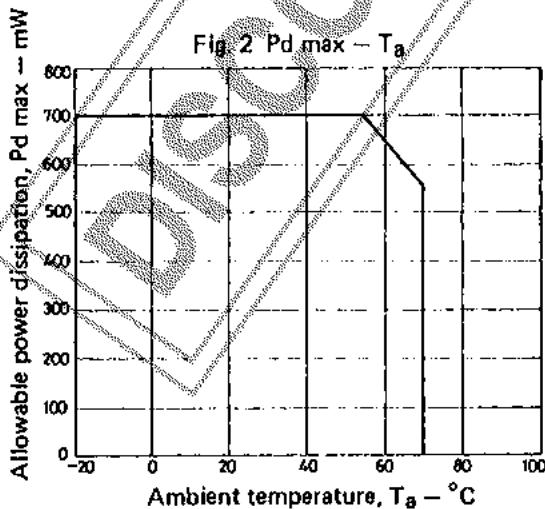
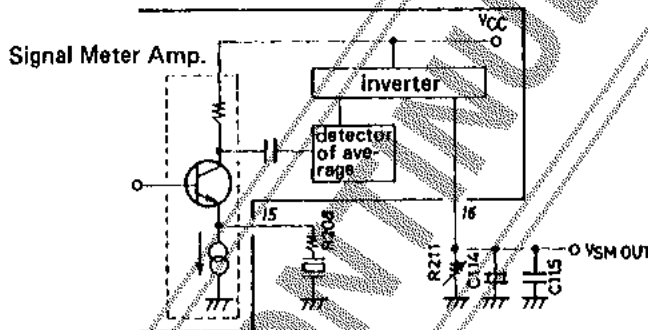

Fig. 2 Pd max - T<sub>a</sub>

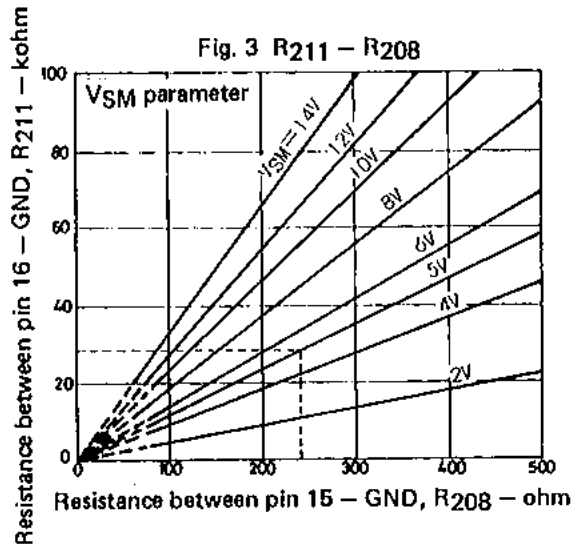
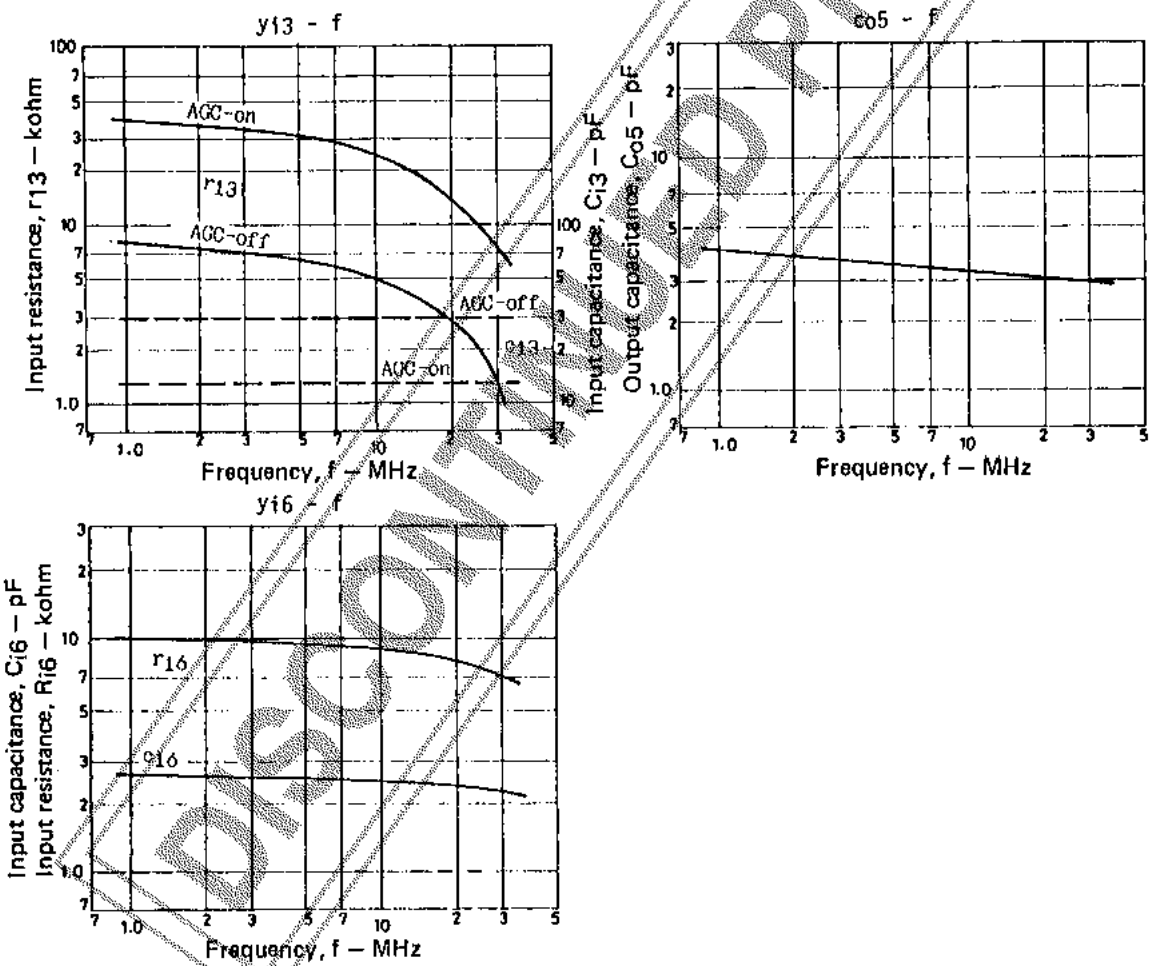

Fig. 3 R<sub>211</sub> - R<sub>208</sub>

Input/Output Admittance

—	parameter	frequency	—	AGC-off	AGC-on
RF	$y_{i3}$	1 MHz	$r_i$ $c_j$	8 k $\Omega$ 30 pF	40 k $\Omega$ 13 pF
	$y_{o5}$	1 MHz	$r_o$ $c_o$	— 4 pF	— —
MIX	$y_{i6}$	1 MHz	$r_i$ $c_j$	10 k $\Omega$ 2.6 pF	— —
	$y_{o7}$	500 kHz	$r_o$ $c_o$	— 2 pF	— —
1st IF	$y_{i9}$	500 kHz	$r_i$ $c_j$	3 k $\Omega$ 7 pF	3.2 k $\Omega$ 3 pF
	$y_{o10}$	500 kHz	$r_o$ $c_o$	45 $\Omega$ 20 pF	42 $\Omega$ 20 pF
2nd IF	$y_{i11}$	500 kHz	$r_i$ $c_j$	80 $\Omega$ —150 pF	— —



Notes on LA1247 usage

- When suddenly tuned to a broadcasting station of intermediate or high field strength, a large current of high frequency flows into the signal meter circuit, causing the local oscillator malfunctions and abnormal noises. To eliminate this:
  - Use  $R_{208} \geq 240$  ohm for manual tuning type.
  - Use  $R_{208} \geq 82$  ohm, and use the local oscillation coil at the 1/3 tap (except SW for electronic tuning type (which uses a narrow band filter)).

2. Use the bias on the condition  $RF V_{CC} \leq IF V_{CC}$ , since abnormal noise levels might be caused when detuning a strong input on the condition  $RF V_{CC} \geq IF V_{CC}$
3. Use the signal meter driving output ( $V_{SM}$ ) at  $V_{SM} \leq V_{CC} - 2 (V)$  to avoid saturation caused by  $V_{CC}$ .
4. Use 1/2 or more tap of LW and MW oscillation coil to improve S/N and the detuning characteristics of the distortion ratio.
5. Use the full-tap of SW oscillation coil, to allow the sag in oscillation power by the decreasing of  $Q$ .
6. Avoid the coupling of the antenna tuning circuit and the local oscillating circuit so as not to leak the local oscillation into the antenna tuning circuit.
7. Connect the detection capacitor  $C_{113}$  between pin 13 (output) and pin 14 ( $V_{CC}$ ) to avoid the leakage of the IF signal into the GND line. Connection between pin 13 and pin 12 (GND) increases the tweet interference and deteriorates the usable sensitivity. Moreover, depending on the positions of  $C_{113}$  and the bar antenna, higher harmonics having twice or three times the frequency of the IF signal may pass into the antenna and cause tweet interference in extreme cases oscillation might be caused. To prevent this:
  - Trim lead wires and connect them near 13 and 14 pins.
  - Place  $C_{113}$  far from the antenna.
8. When a cable or something similar is connected to a local oscillation buffer (pin 20), which is equivalent to connecting a capacitor of about 20 pF, the output from the buffer will be of sawtooth waves, causing the level low at the short wave band. To prevent this, connect a resistor between pin 20 and GND, which will increase the operating current of the buffer amplifier. Since the maximum current obtained from pin 20 is 2 mA, the suitable resistance between pin 20 and GND is 1.5 kohm.
9. Use a semi-fixed resistor for  $R_{211}$  to allow the fluctuation of  $V_{SM}$ .
10. When changing an IFT or using an RF tuner, select a filter and related circuits according to the following conditions. The input levels of each terminal where 30% modulated detection output of -25 dB is obtained are as follows:

Pin 11 input	when $R_g = 520 \text{ ohm} (470 \text{ ohm} + 50 \text{ ohm})$	75 dB $\mu$
Pin 9 input	when $R_g = 50 \text{ ohm}$	53 dB $\mu$
Pin 6 input	when $R_g = 50 \text{ ohm}$	48 dB $\mu$
Pin 3 input	when $R_g = 50 \text{ ohm}$	22 dB $\mu$

Slight change in IFT, however, will be covered by changing the constant of resistors  $R_{202}$  and  $R_{204}$ .

■ Application 1

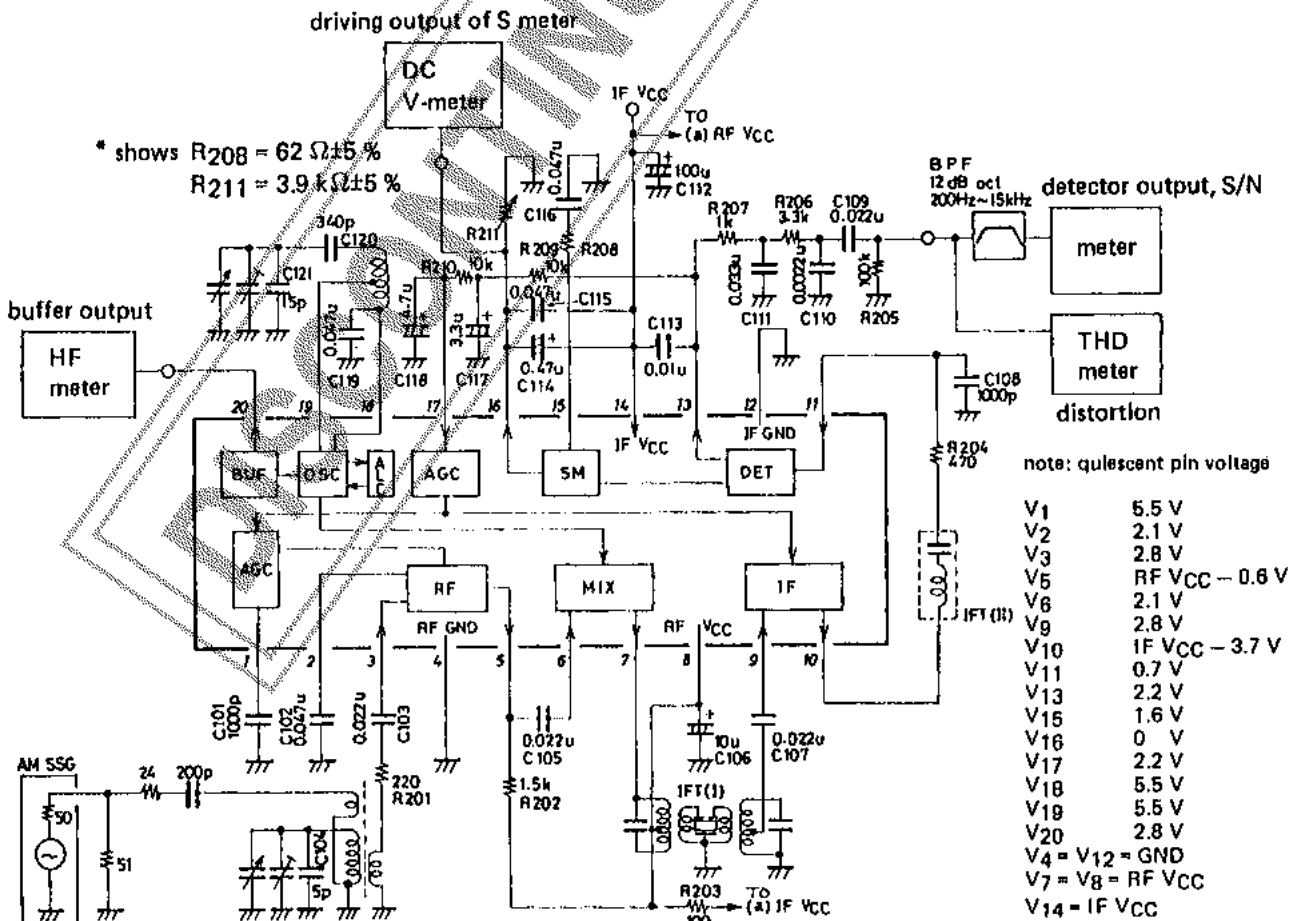

# LA1247

□ Subchannel S/N test circuit

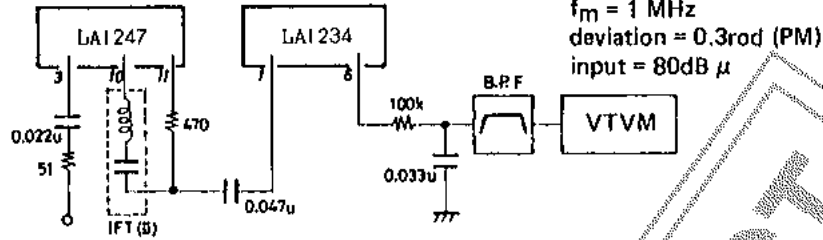

VCC = 12V  
 $f_r = 1 \text{ MHz}$   
 $f_m = 1 \text{ MHz}$   
 deviation = 0.3rod (PM)  
 input = 80dB  $\mu$

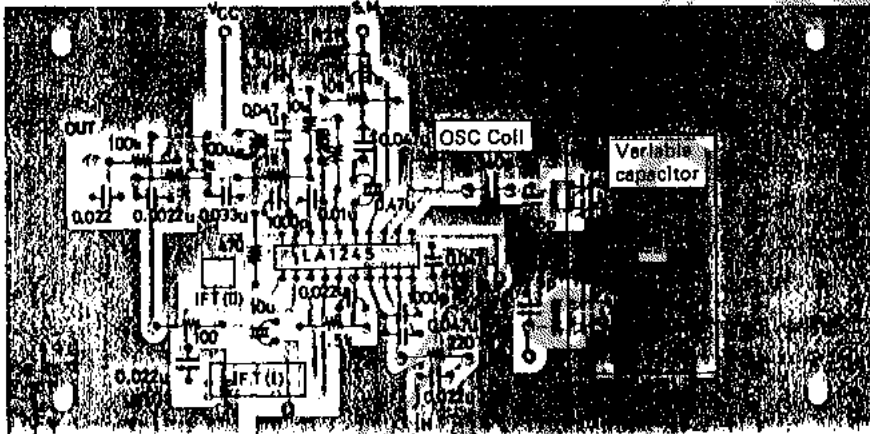

An Example of Printed Pattern (Cu-foild area) (150 x 72 mm<sup>2</sup>)

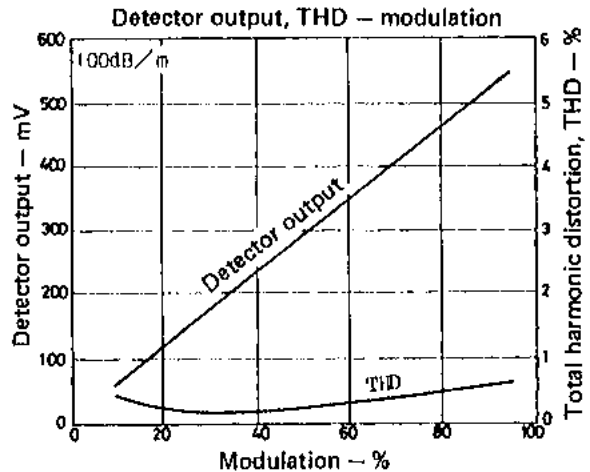
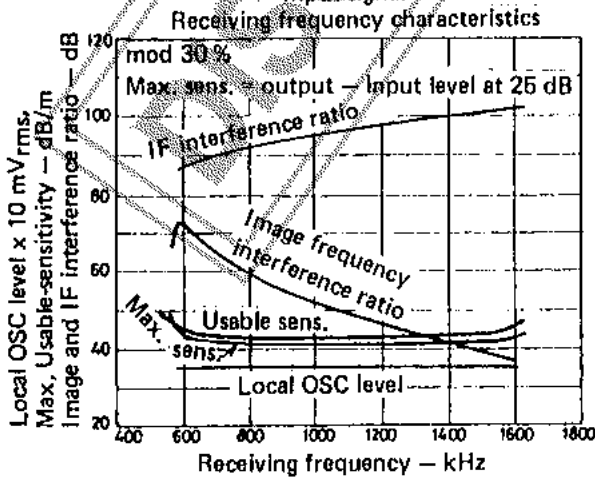
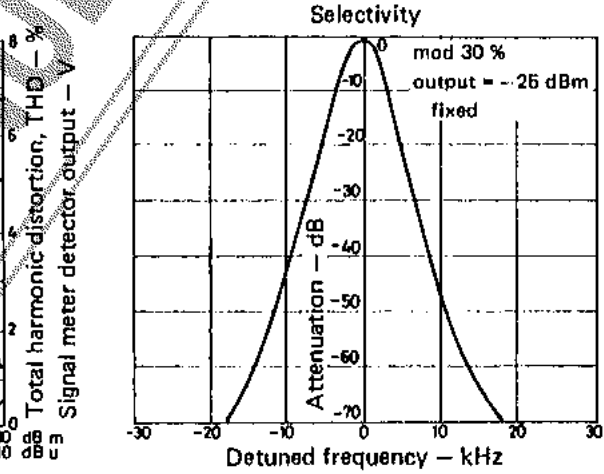
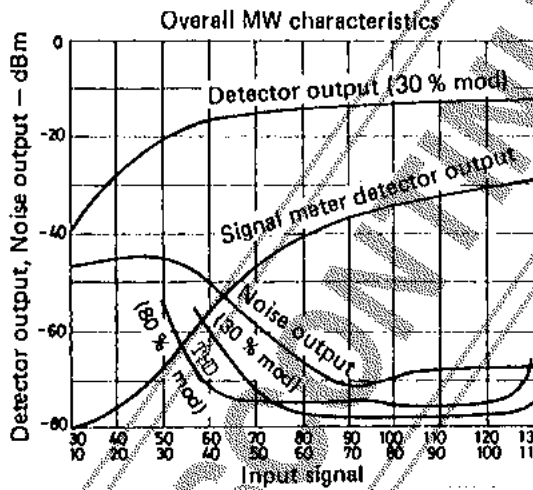

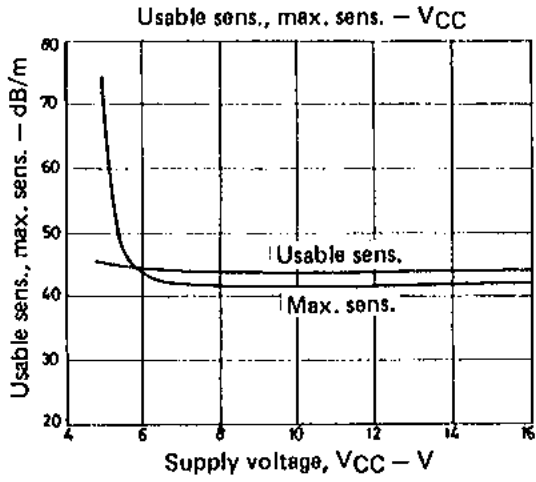
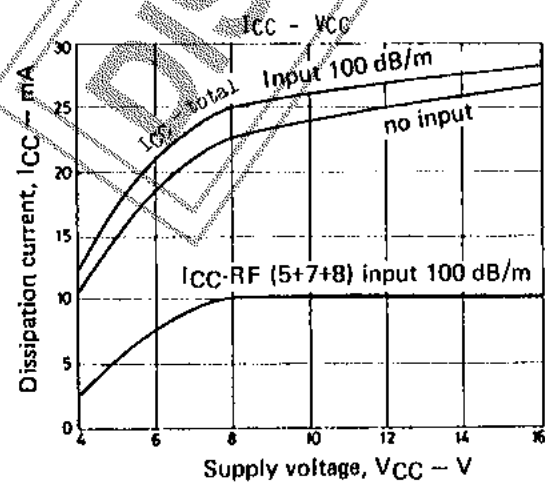
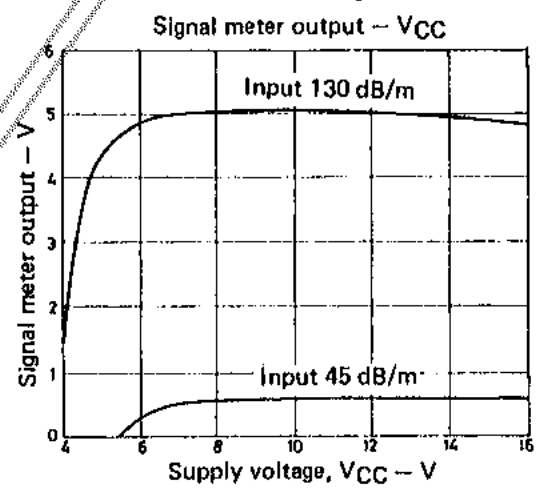
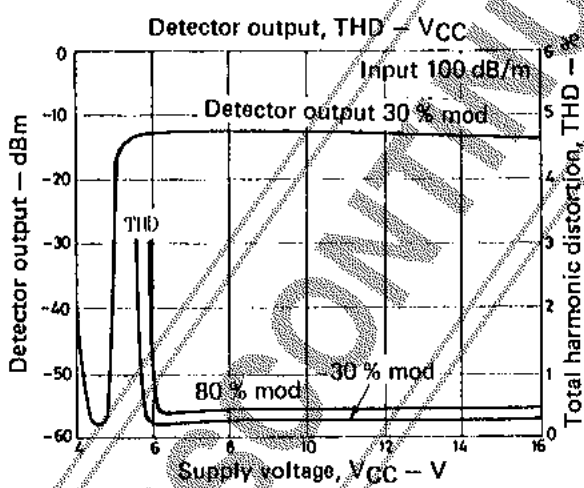
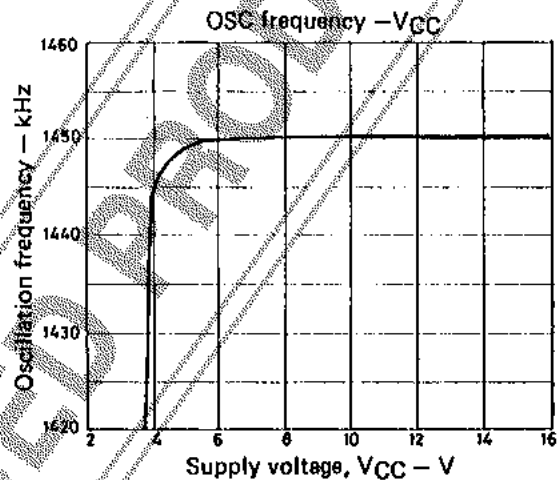
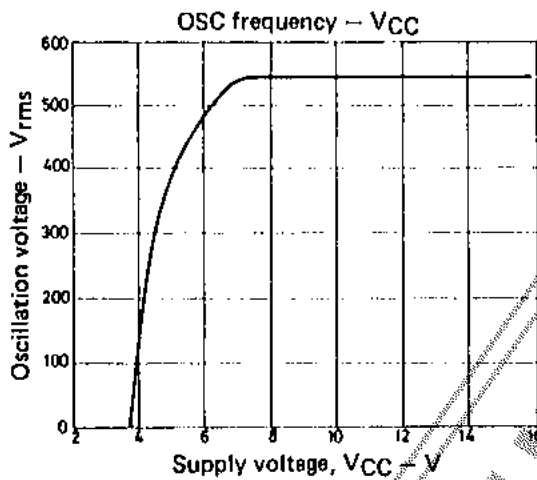
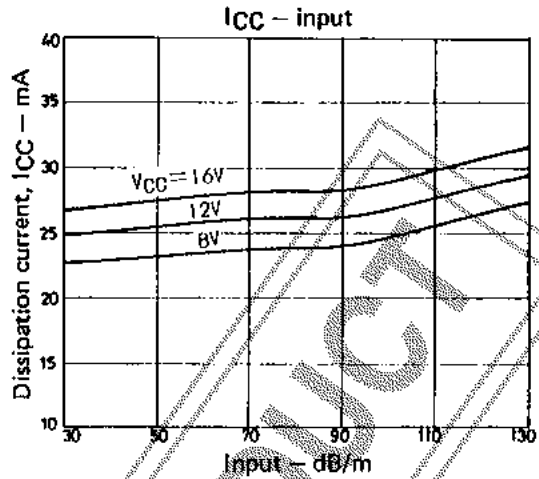
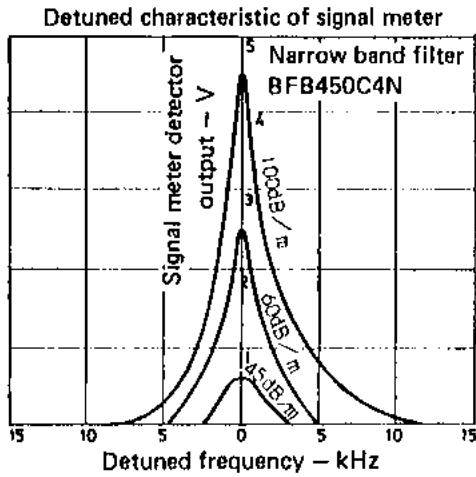







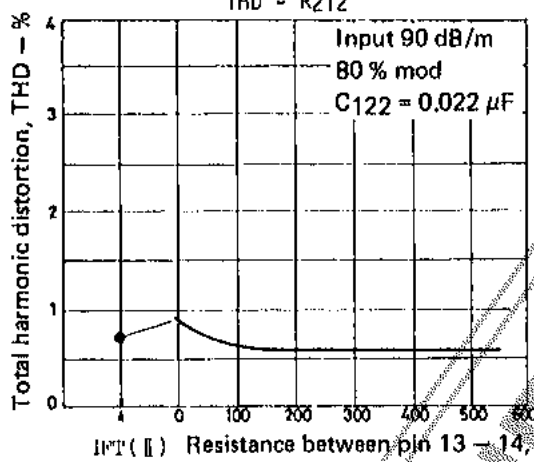
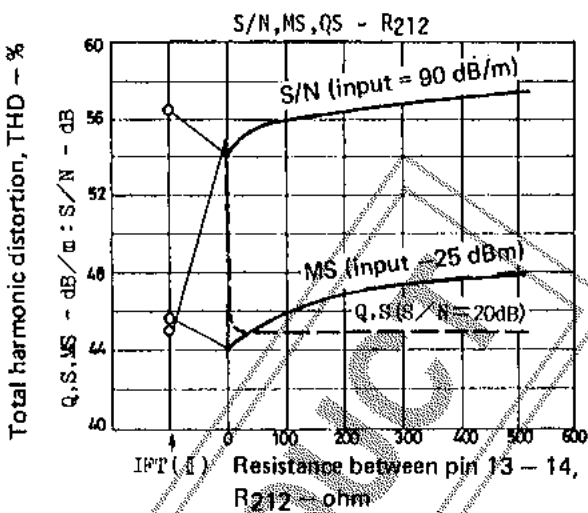
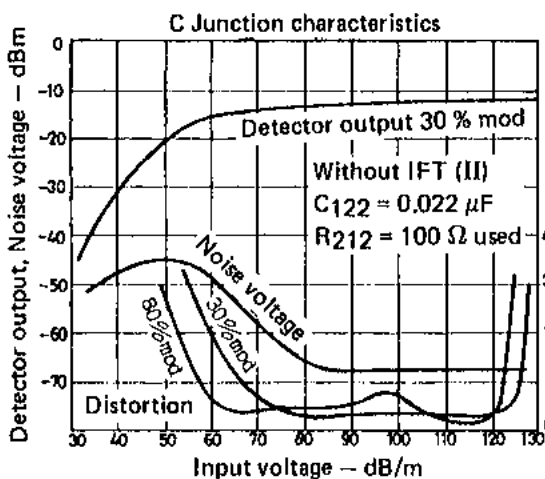

Peripheral Parts

- (1) Bar Antenna (34H-052-869 Sumida Co.)

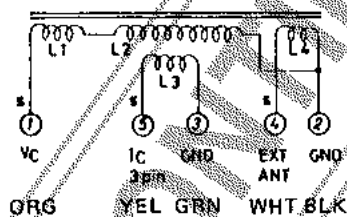

For use of general variable capacitor

L (between pin 1, 2) = 270 μH

Q ≥ 180

- L1: solenoid 43 t.
- L2: space 42 t.
- L3: solenoid 7 t.
- L4: solenoid 4 t.

- (2) Bar Antenna (C-4698 Coil Snake Co.,)

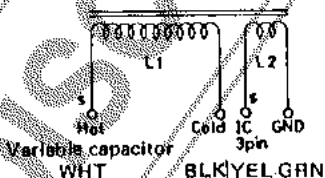

For use of variable capacitor diode

L (between pin 1, 2) = 250 μH

Q ≥ 250

- L1: solenoid 55 t.
- L2: solenoid 5 t.

- (3) Osc coil

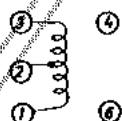

2157-223-072 Sumida

2157-223-082 Sumida

7BR-6654Y Toko

L (between pin 1 and 3) = 147 μH

L (between pin 1 and 3) = 147 μH

L (between pin 1 and 3) = 147 μH

Q ≥ 85

Q ≥ 85

Q ≥ 90

- 3 - 2 39 t.
- 2 - 1 39 t.

- 3 - 2 26 t.
- 2 - 1 52 t.

- 3 - 2 31 t.
- 2 - 1 31 t.

(4) Variable Capacitor (C123A Alps Co.,)

c max 326.8 pF  
c min 6.7 pF

(5) Variable Capacitor Diode (SVC332 Sanyo)

(6) IFT (I) (CMFQ-021A Toko Co.,)

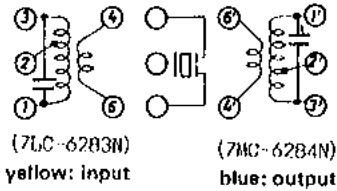

CMFQ-021A

3-2	58 t.	3-2	18 t.
2-1	98 t.	2-1	130 t.
6-4	16 t.	6-4	16 t.
Cent. Freq. 450 kHz		Cent. Freq. 450 kHz	
Qu = 70 + 20%		Qu = 110	
Tuned Cap. 180 pF		Tuned Cap. 180 pF	

(7) IFT (II)

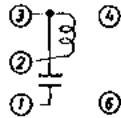

2150-208-033 Sumida Co.,  
Cent. Freq. 455 kHz  
Q ≥ 95  
between 2 and 3 170 t.  
Tuned Cap. 180 pF  
2150-208-033 Sumida Co.,

7LC-4751B Toko Co.,  
Cent. Freq. 455 kHz  
Q ≥ 75  
between 2 and 3 146 t.  
Tuned Cap. 180 pF  
7LC-4751B Toko Co.,

(8) Narrow Band Resonator (BFB450C4 N Murata Co.,)

