

## HIGH VOLTAGE FAST-SWITCHING NPN POWER TRANSISTOR

- SGS-THOMSON PREFERRED SALESTYPE
- HIGH VOLTAGE CAPABILITY
- U.L. RECOGNISED ISOWATT218 PACKAGE (U.L. FILE # E81734 (N)).

### APPLICATIONS:

- HORIZONTAL DEFLECTION FOR COLOUR TV

### DESCRIPTION

The S2000AFI is manufactured using Multiepitaxial Mesa technology for cost-effective high performance and uses a Hollow Emitter structure to enhance switching speeds.

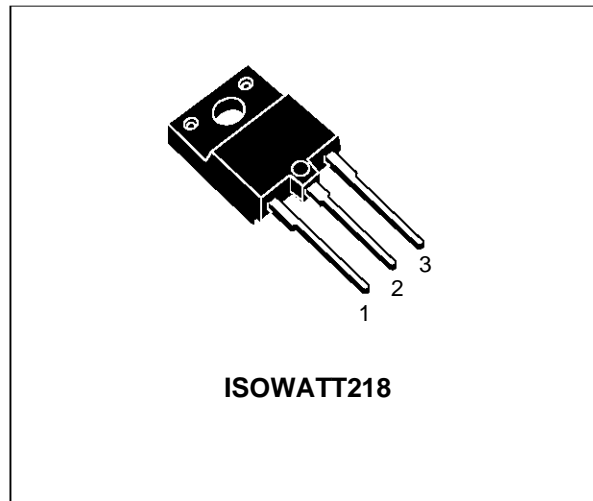

### INTERNAL SCHEMATIC DIAGRAM

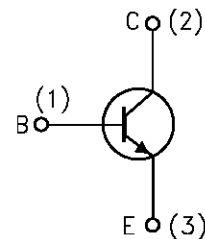

### ABSOLUTE MAXIMUM RATINGS

Symbol	Parameter	Value	Unit
$V_{CES}$	Collector-Emitter Voltage ( $V_{BE} = 0$ )	1500	V
$V_{CEO}$	Collector-Emitter Voltage ( $I_B = 0$ )	700	V
$V_{EBO}$	Emitter-Base Voltage ( $I_C = 0$ )	10	V
$I_C$	Collector Current	8	A
$I_{CM}$	Collector Peak Current ( $t_p < 5$ ms)	15	A
$P_{tot}$	Total Dissipation at $T_c = 25$ °C	50	W
$T_{stg}$	Storage Temperature	-65 to 150	°C
$T_j$	Max. Operating Junction Temperature	150	°C

# S2000AFI

## THERMAL DATA

R <sub>thj-case</sub>	Thermal Resistance Junction-case	Max	2.5	°C/W
-----------------------	----------------------------------	-----	-----	------

## ELECTRICAL CHARACTERISTICS (T<sub>case</sub> = 25 °C unless otherwise specified)

Symbol	Parameter	Test Conditions	Min.	Typ.	Max.	Unit
I <sub>CES</sub>	Collector Cut-off Current (V <sub>BE</sub> = 0)	V <sub>CE</sub> = 1500 V V <sub>CE</sub> = 1500 V			1 2	mA mA
I <sub>EBO</sub>	Emitter Cut-off Current (I <sub>C</sub> = 0)	V <sub>EB</sub> = 5 V			100	μA
V <sub>CEO(sus)</sub>	Collector-Emitter Sustaining Voltage	I <sub>C</sub> = 100 mA	700			V
V <sub>EBO</sub>	Emitter Base Voltage (I <sub>C</sub> = 0)	I <sub>E</sub> = 10 mA	10			V
V <sub>CE(sat)*</sub>	Collector-Emitter Saturation Voltage	I <sub>C</sub> = 4.5 A I <sub>B</sub> = 2 A			1	V
V <sub>BE(sat)*</sub>	Base-Emitter Saturation Voltage	I <sub>C</sub> = 4.5 A I <sub>B</sub> = 2 A			1.3	V
t <sub>s</sub> t <sub>f</sub>	INDUCTIVE LOAD Storage Time Fall Time	I <sub>C</sub> = 4.5 A L <sub>C</sub> = 0.9 mH h <sub>FE</sub> = 2.5 L <sub>B</sub> = 3 μH V <sub>CC</sub> = 140 V		7 0.55		μs μs
f <sub>T</sub>	Transition Frequency	I <sub>C</sub> = 0.1 A V <sub>CE</sub> = 5 V f = 5 MHz		7		MHz

\* Pulsed: Pulse duration = 300 μs, duty cycle 1.5 %

Safe Operating Area.

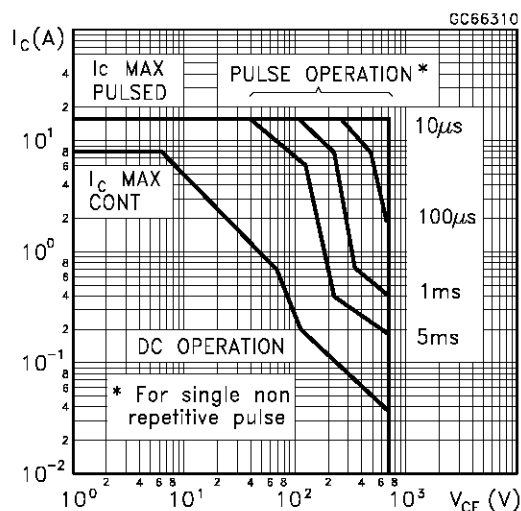

Thermal Impedance

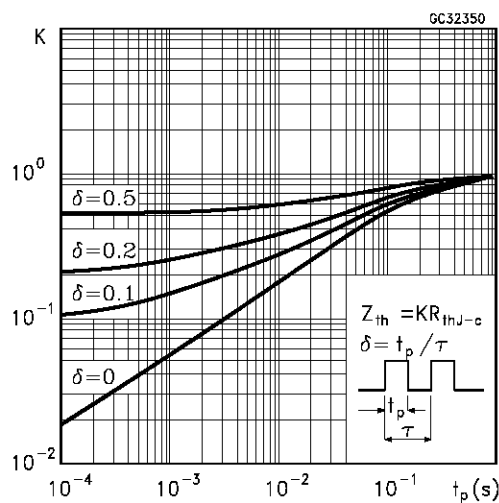

DC Current Gain

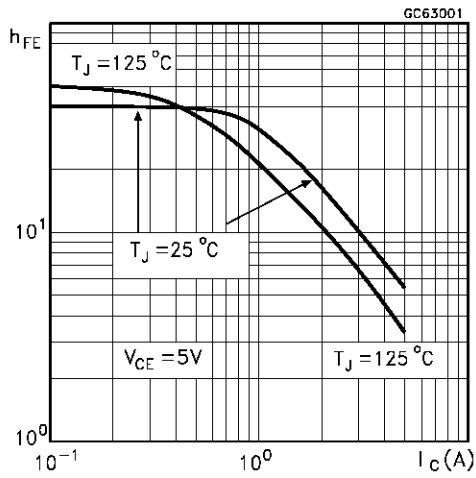

Collector Emitter Saturation Voltage

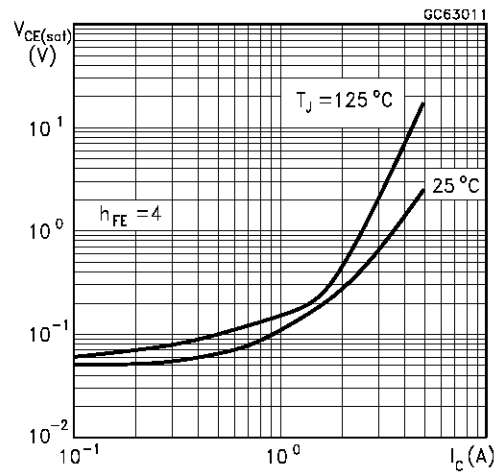

Base Emitter Saturation Voltage

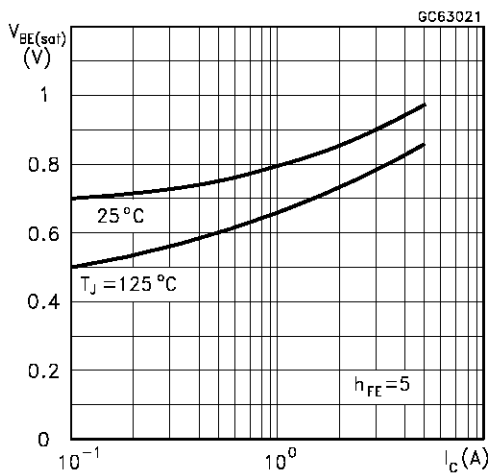

Switching Time Inductive Load

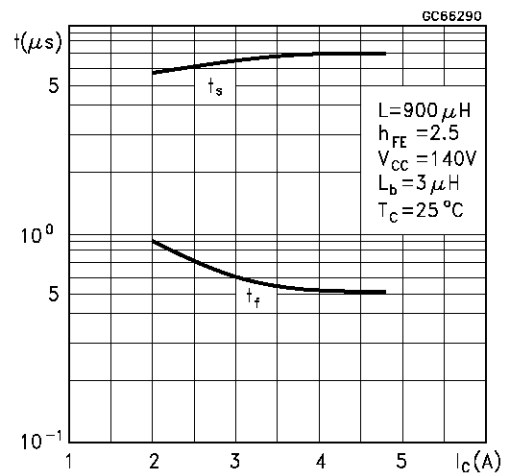

Switching Time Inductive Load (see figure 1)

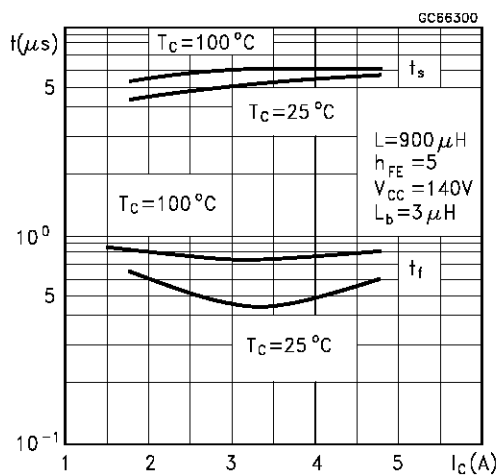
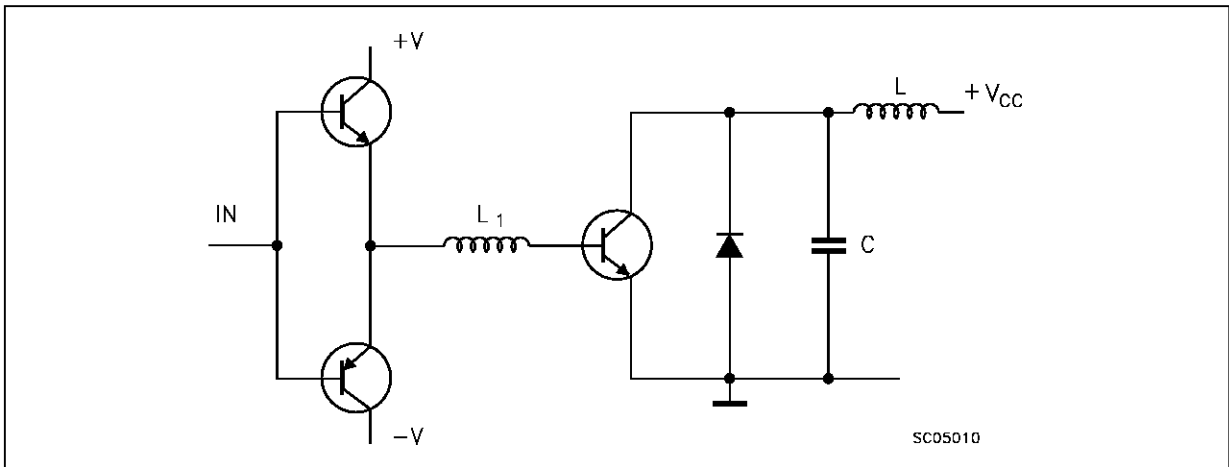
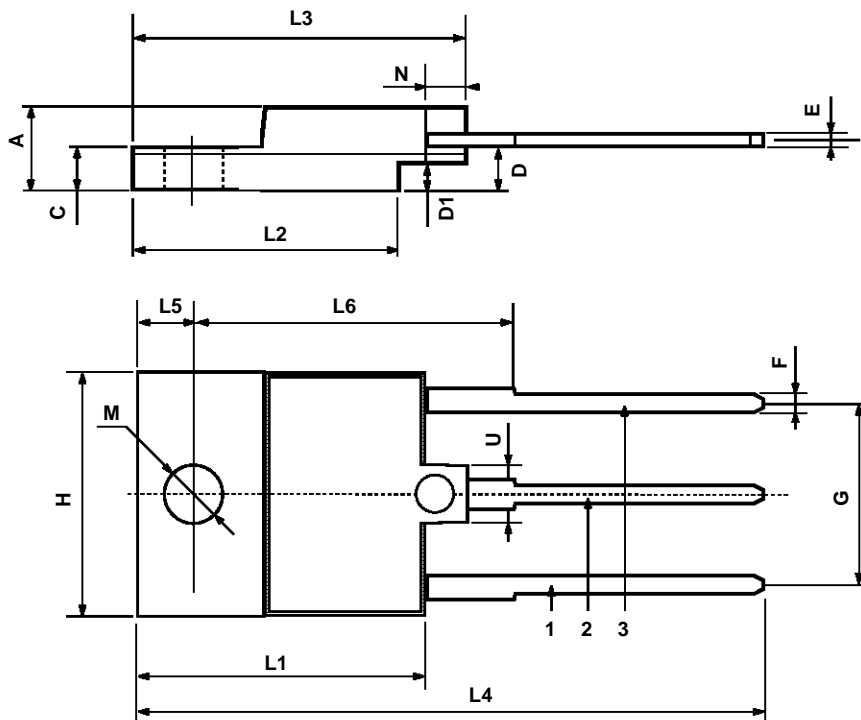

Figure 1: Inductive Load Switching Test Circuit.



## ISOWATT218 MECHANICAL DATA

DIM.	mm			inch		
	MIN.	TYP.	MAX.	MIN.	TYP.	MAX.
A	5.35		5.65	0.210		0.222
C	3.3		3.8	0.130		0.149
D	2.9		3.1	0.114		0.122
D1	1.88		2.08	0.074		0.081
E	0.75		1	0.029		0.039
F	1.05		1.25	0.041		0.049
G	10.8		11.2	0.425		0.441
H	15.8		16.2	0.622		0.637
L1	20.8		21.2	0.818		0.834
L2	19.1		19.9	0.752		0.783
L3	22.8		23.6	0.897		0.929
L4	40.5		42.5	1.594		1.673
L5	4.85		5.25	0.190		0.206
L6	20.25		20.75	0.797		0.817
M	3.5		3.7	0.137		0.145
N	2.1		2.3	0.082		0.090
U		4.6			0.181	



P025C

Information furnished is believed to be accurate and reliable. However, SGS-THOMSON Microelectronics assumes no responsibility for the consequences of use of such information nor for any infringement of patents or other rights of third parties which may result from its use. No license is granted by implication or otherwise under any patent or patent rights of SGS-THOMSON Microelectronics. Specifications mentioned in this publication are subject to change without notice. This publication supersedes and replaces all information previously supplied. SGS-THOMSON Microelectronics products are not authorized for use as critical components in life support devices or systems without express written approval of SGS-THOMSON Microelectronics.

© 1997 SGS-THOMSON Microelectronics - Printed in Italy - All Rights Reserved

SGS-THOMSON Microelectronics GROUP OF COMPANIES  
Australia - Brazil - Canada - China - France - Germany - Hong Kong - Italy - Japan - Korea - Malaysia - Malta - Morocco - The Netherlands -  
Singapore - Spain - Sweden - Switzerland - Taiwan - Thailand - United Kingdom - U.S.A

...