

FEATURES

- Charges Single-Cell Li-Ion Batteries from Wall Adapter and USB Inputs
- Automatic Input Power Detection and Selection
- Charge Current Programmable up to 950mA from Wall Adapter Input
- No External MOSFET, Sense Resistor or Blocking Diode Needed
- Thermal Regulation Maximizes Charging Rate Without Risk of Overheating*
- Preset Charge Voltage with $\pm 0.6\%$ Accuracy
- Programmable Charge Current Termination
- 18 μ A USB Suspend Current in Shutdown
- Independent “Power Present” Status Outputs
- Charge Status Output
- Automatic Recharge
- Available Without Trickle Charge (LTC4075X)
- Available in a Thermally Enhanced, Low Profile (0.75mm) 10-Lead (3mm \times 3mm) DFN Package

APPLICATIONS

- Cellular Telephones
- Handheld Computers
- Portable MP3 Players
- Digital Cameras

DESCRIPTION

The LTC[®]4075/LTC4075X are standalone linear chargers that are capable of charging a single-cell Li-Ion battery from both wall adapter and USB inputs. The chargers can detect power at the inputs and automatically select the appropriate power source for charging.

No external sense resistor or blocking diode is required for charging due to the internal MOSFET architecture. Internal thermal feedback regulates the battery charge current to maintain a constant die temperature during high power operation or high ambient temperature conditions. The float voltage is fixed at 4.2V and the charge current is programmed with an external resistor. The LTC4075 terminates the charge cycle when the charge current drops below the programmed termination threshold after the final float voltage is reached. With power applied to both inputs, the LTC4075/LTC4075X can be put into shutdown mode reducing the DCIN supply current to 20 μ A, the USBIN supply current to 10 μ A, and the battery drain current to less than 2 μ A.

Other features include automatic recharge, undervoltage lockout, charge status outputs, and “power present” status outputs to indicate the presence of wall adapter or USB power.

LT, LTC and LT are registered trademarks of Linear Technology Corporation. All other trademarks are the property of their respective owners. *Protected by U.S. patents, including 6522118, 6700364

TYPICAL APPLICATION

Dual Input Battery Charger for Single-Cell Li-Ion

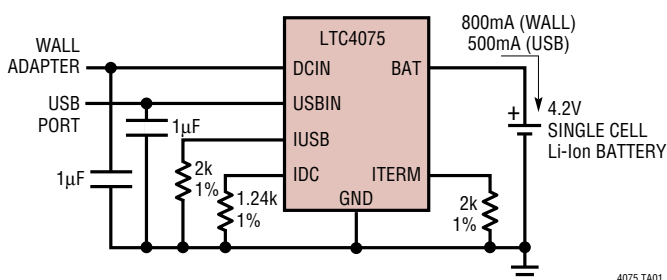

4075 TA01

Complete Charge Cycle (1100mAh Battery)

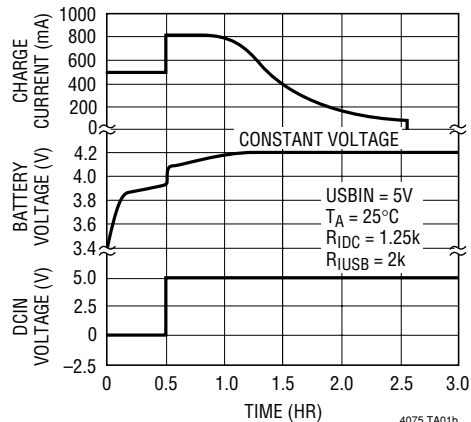

4075 TA01b

LTC4075/LTC4075X

ABSOLUTE MAXIMUM RATINGS

(Note 1)

Input Supply Voltage (DCIN, USBIN)	-0.3 to 10V
EN, CHRG, PWR, USBPWR.....	-0.3 to 10V
BAT, IDC, IUSB, ITERM	-0.3 to 7V
DCIN Pin Current (Note 7)	1A
USBIN Pin Current (Note 7)	700mA
BAT Pin Current (Note 7)	1A
BAT Short-Circuit Duration.....	Continuous
Maximum Junction Temperature	125°C
Operating Temperature Range (Note 2) ..	-40°C to 85°C
Storage Temperature Range.....	-65°C to 125°C

PACKAGE/ORDER INFORMATION

	ORDER PART NUMBER
	LTC4075EDD LTC4075XEDD
	DD PART MARKING
	LBSC LBRK

Consult LTC Marketing for parts specified with wider operating temperature ranges.

ELECTRICAL CHARACTERISTICS

The ● denotes the specifications which apply over the full operating temperature range, otherwise specifications are at $T_A = 25^\circ\text{C}$. $V_{DCIN} = 5\text{V}$, $V_{USBIN} = 5\text{V}$ unless otherwise noted.

SYMBOL	PARAMETER	CONDITIONS	MIN	TYP	MAX	UNITS
V_{DCIN}	Supply Voltage		● 4.3		8	V
V_{USBIN}	Supply Voltage		● 4.3		8	V
I_{DCIN}	DCIN Supply Current	Charge Mode (Note 4), $R_{IDC} = 10\text{k}$ Standby Mode; Charge Terminated Shutdown Mode (ENABLE = 5V)	●	250 50 20	800 100 40	μA μA μA
I_{USBIN}	USBIN Supply Current	Charge Mode (Note 5), $R_{IUSB} = 10\text{k}$, $V_{DCIN} = 0\text{V}$ Standby Mode; Charge Terminated, $V_{DCIN} = 0\text{V}$ Shutdown ($V_{DCIN} = 0\text{V}$, ENABLE = 0V) $V_{DCIN} > V_{USBIN}$	●	250 50 18 10	800 100 36 20	μA μA μA μA
V_{FLOAT}	Regulated Output (Float) Voltage	$I_{BAT} = 1\text{mA}$ $I_{BAT} = 1\text{mA}$, $0^\circ\text{C} < T_A < 85^\circ\text{C}$	4.175 4.158	4.2	4.225 4.242	V V
I_{BAT}	BAT Pin Current	$R_{IDC} = 1.25\text{k}$, Constant-Current Mode $R_{IUSB} = 2.1\text{k}$, Constant-Current Mode $R_{IDC} = 10\text{k}$ or $R_{IUSB} = 10\text{k}$ Standby Mode, Charge Terminated Shutdown Mode (Charger Disabled) Sleep Mode ($V_{DCIN} = 0\text{V}$, $V_{USBIN} = 0\text{V}$)	● 760 ● 450 ● 93	800 476 100	840 500 107	mA mA mA
				-3 -1 ± 1	-6 -2 ± 2	μA μA μA
V_{IDC}	IDC Pin Regulated Voltage	Constant-Current Mode	0.95	1	1.05	V
V_{IUSB}	IUSB Pin Regulated Voltage	Constant-Current Mode	0.95	1	1.05	V
$I_{TERMINATE}$	Charge Current Termination Threshold	$R_{ITERM} = 1\text{k}$ $R_{ITERM} = 2\text{k}$ $R_{ITERM} = 10\text{k}$ $R_{ITERM} = 20\text{k}$	● 90 ● 45 ● 8.5 ● 4	100 50 10 5	110 55 11.5 6	mA mA mA mA
I_{TRIKL}	Trickle Charge Current (Note 6)	$V_{BAT} < V_{TRIKL}$; $R_{IDC} = 1.25\text{k}$ $V_{BAT} < V_{TRIKL}$; $R_{IUSB} = 2.1\text{k}$	60 30	80 47.5	100 65	mA mA
V_{TRIKL}	Trickle Charge Threshold (Note 6)	V_{BAT} Rising Hysteresis	2.8	2.9 100	3	V mV
V_{UVDC}	DCIN Undervoltage Lockout Voltage	From Low to High Hysteresis	4	4.15 200	4.3	V mV
V_{UVUSB}	USBIN Undervoltage Lockout Voltage	From Low to High Hysteresis	3.8	3.95 200	4.1	V mV

4075Xf

ELECTRICAL CHARACTERISTICS

The ● denotes the specifications which apply over the full operating temperature range, otherwise specifications are at $T_A = 25^\circ\text{C}$. $V_{\text{DCIN}} = 5\text{V}$, $V_{\text{USBIN}} = 5\text{V}$ unless otherwise noted.

SYMBOL	PARAMETER	CONDITIONS	MIN	TYP	MAX	UNITS
$V_{\text{ASD-DC}}$	$V_{\text{DCIN}} - V_{\text{BAT}}$ Lockout Threshold	V_{DCIN} from Low to High, $V_{\text{BAT}} = 4.2\text{V}$	140	180	220	mV
		V_{DCIN} from High to Low, $V_{\text{BAT}} = 4.2\text{V}$	20	50	80	mV
$V_{\text{ASD-USB}}$	$V_{\text{USBIN}} - V_{\text{BAT}}$ Lockout Threshold	V_{USBIN} from Low to High	140	180	220	mV
		V_{USBIN} from High to Low	20	50	80	mV
V_{ENABLE}	ENABLE Input Threshold Voltage		0.4	0.7	1	V
R_{ENABLE}	ENABLE Pulldown Resistance		● 1.2	2	5	M Ω
V_{CHRG}	CHRG Output Low Voltage	$I_{\text{CHRG}} = 5\text{mA}$		0.35	0.6	V
V_{PWR}	PWR Output Low Voltage	$I_{\text{PWR}} = 5\text{mA}$		0.35	0.6	V
V_{USBPWR}	USBPWR Output Low Voltage	$I_{\text{USBPWR}} = 300\mu\text{A}$		0.35	0.6	V
ΔV_{RECHRG}	Recharge Battery Threshold	$V_{\text{FLOAT}} - V_{\text{RECHRG}}$, $0^\circ\text{C} < T_A < 85^\circ\text{C}$	65	100	135	mV
t_{RECHRG}	Recharge Comparator Filter Time	V_{BAT} from High to Low	3	6	9	ms
$t_{\text{TERMINATE}}$	Termination Comparator Filter Time	I_{BAT} Drops Below Termination Threshold	0.8	1.5	2.2	ms
t_{SS}	Soft-Start Time	$I_{\text{BAT}} = 0$ to Full-Scale	175	250	325	μs
$R_{\text{ON-DC}}$	Power FET "ON" Resistance (Between DCIN and BAT)			400		m Ω
$R_{\text{ON-USB}}$	Power FET "ON" Resistance (Between USBIN and BAT)			550		m Ω
T_{LIM}	Junction Temperature in Constant-Temperature Mode			105		$^\circ\text{C}$

Note 1: Absolute Maximum Ratings are those values beyond which the life of a device may be impaired.

Note 2: The LTC4075E/LTC4075XE are guaranteed to meet the performance specifications from 0°C to 70°C . Specifications over the -40°C to 85°C operating temperature range are assured by design, characterization and correlation with statistical process controls.

Note 3: Failure to correctly solder the exposed backside of the package to the PC board will result in a thermal resistance much higher than 40°C/W . See Thermal Considerations.

Note 4: Supply current includes I_{DC} and I_{TERM} pin current (approximately $100\mu\text{A}$ each) but does not include any current delivered to the battery through the BAT pin.

Note 5: Supply current includes I_{USB} and I_{TERM} pin current (approximately $100\mu\text{A}$ each) but does not include any current delivered to the battery through the BAT pin.

Note 6: This parameter is not applicable to the LTC4075X.

Note 7: Guaranteed by long term current density limitations.

TYPICAL PERFORMANCE CHARACTERISTICS

Regulated Output (Float) Voltage vs Charge Current

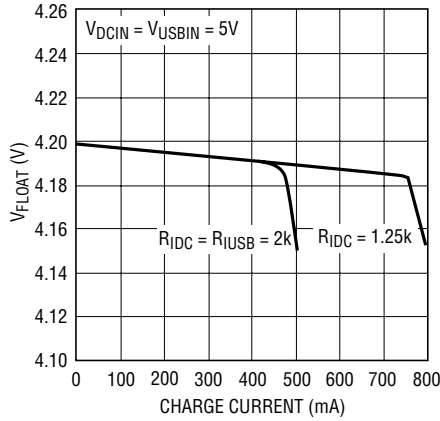

4075X G01

Regulated Output (Float) Voltage vs Temperature

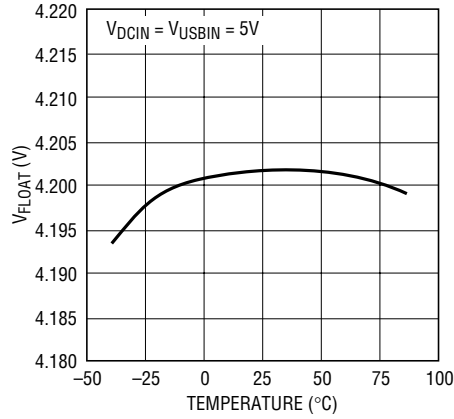

4075X G02

IDC Pin Voltage vs Temperature (Constant-Current Mode)

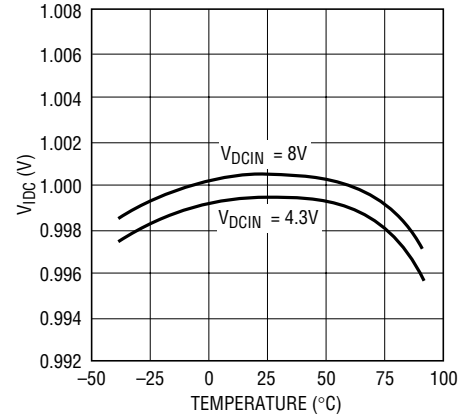

4075X G03

IUSB Pin Voltage vs Temperature (Constant-Current Mode)

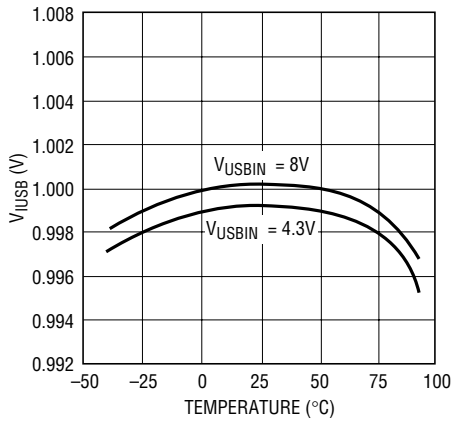

4075X G04

Charge Current vs IDC Pin Voltage

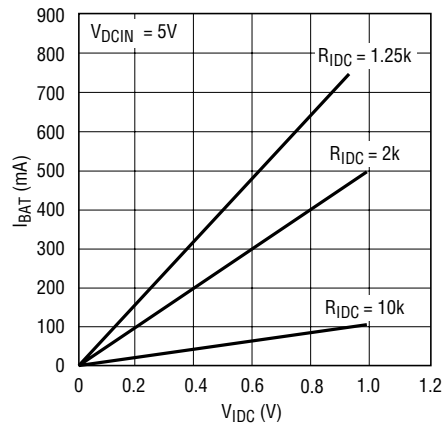

4075X G05

Charge Current vs IUSB Pin Voltage

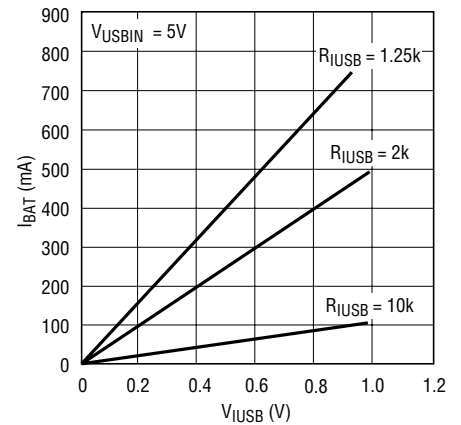

4075X G06

PWR Pin I-V Curve

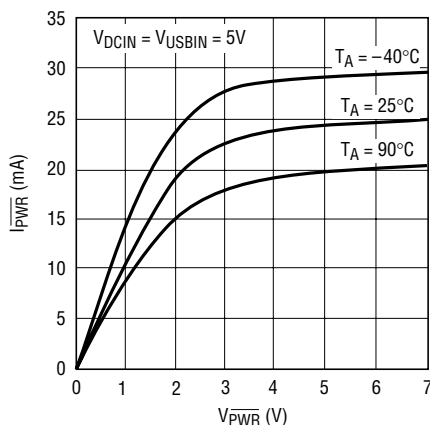

4075X G07

CHRG Pin I-V Curve

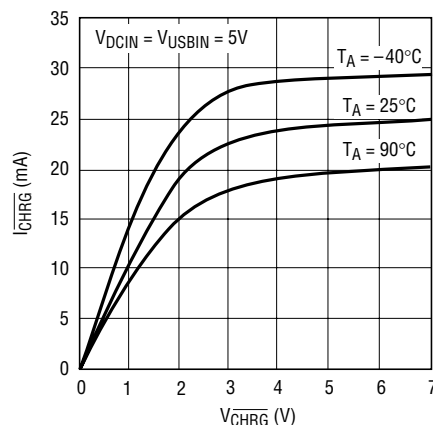

4075X G08

USBPWR Pin I-V Curve

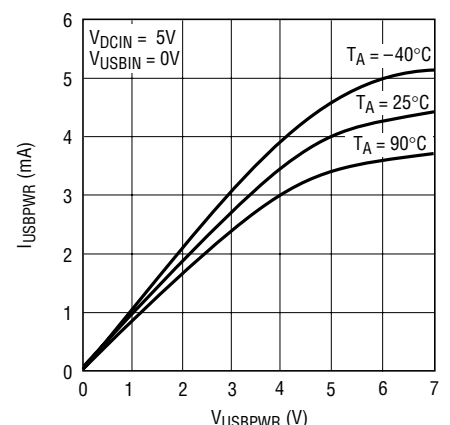

4075X G09

TYPICAL PERFORMANCE CHARACTERISTICS

Charge Current vs Ambient Temperature

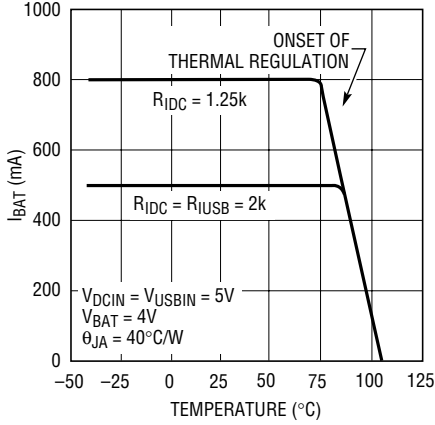

4075X G10

Charge Current vs Supply Voltage

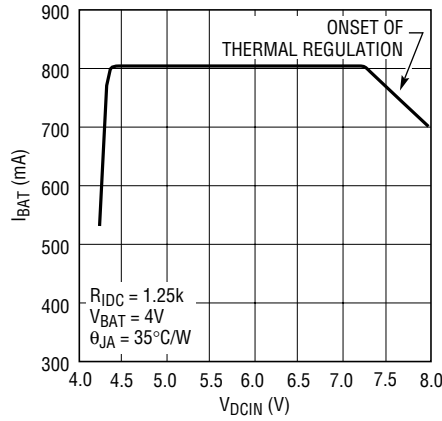

4075X G11

Charge Current vs Battery Voltage

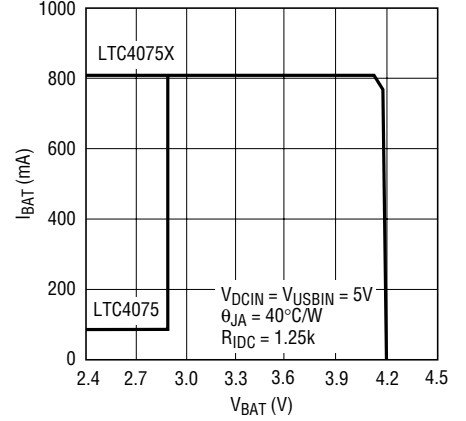

4075X G12

DCIN Power FET "On" Resistance vs Temperature

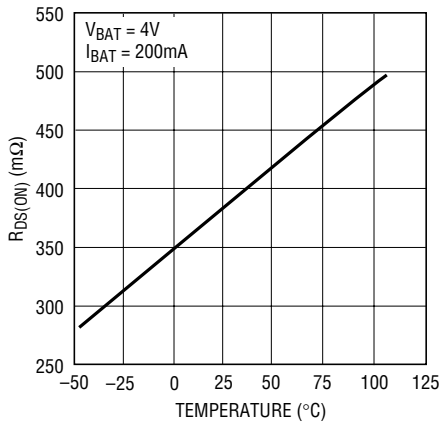

4075X G13

USBIN Power "On" Resistance vs Temperature

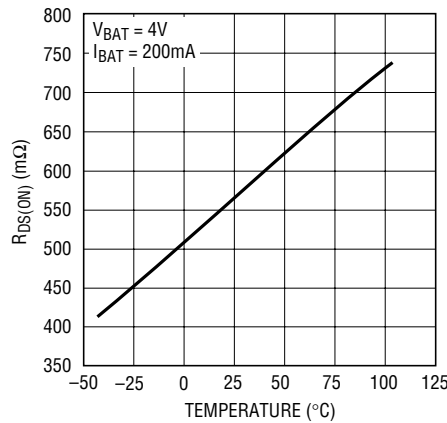

4075X G14

ENABLE Pin Threshold (On-to-Off) vs Temperature

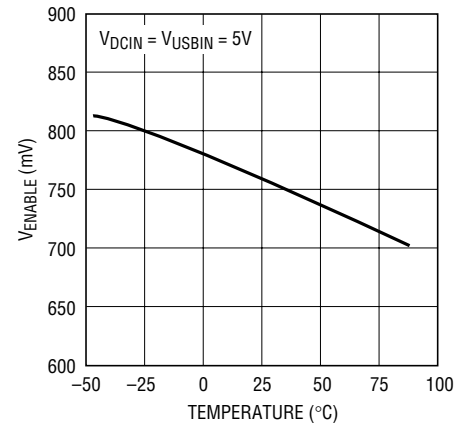

4075X G15

DCIN Shutdown Current vs Temperature

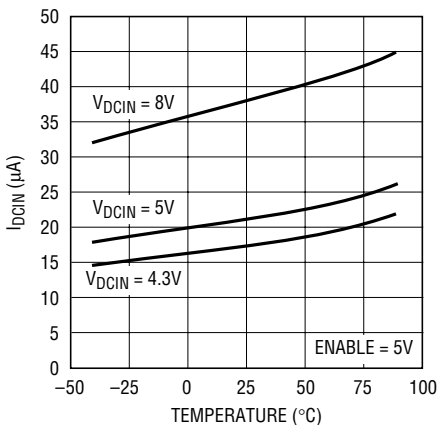

4075X G16

USBIN Shutdown Current vs Temperature

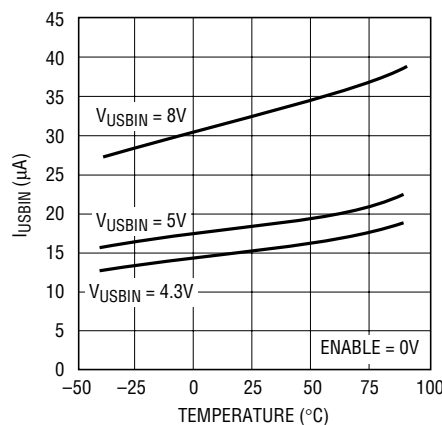

4075X G17

ENABLE Pin Pulldown Resistance vs Temperature

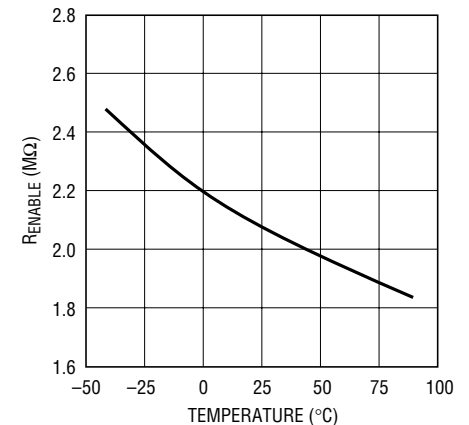

4075X G18

TYPICAL PERFORMANCE CHARACTERISTICS

Undervoltage Lockout Threshold vs Temperature

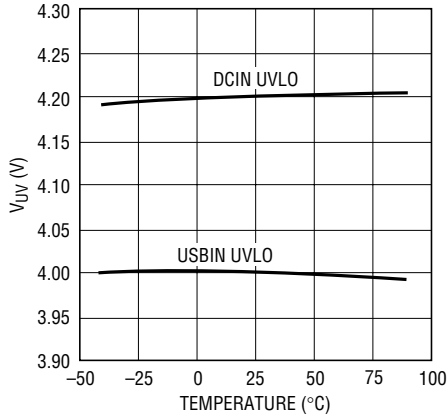

4075X G19

Recharge Threshold vs Temperature

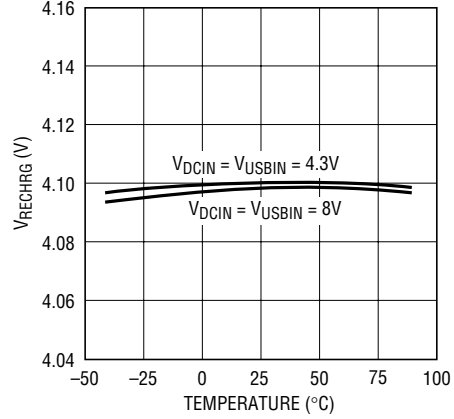

4075X G20

Battery Drain Current vs Temperature

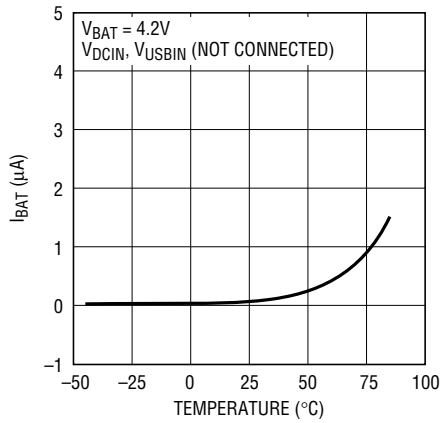

4075X G21

Charge Current During Turn-On and Turn-Off

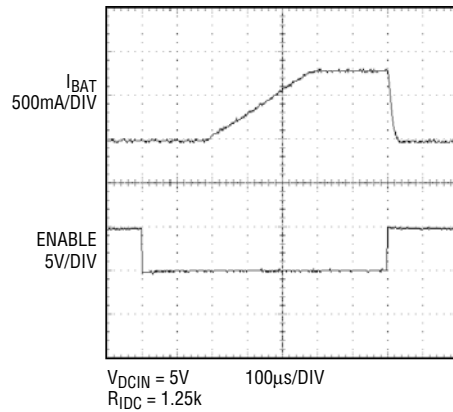

4075X G22

PIN FUNCTIONS

USBIN (Pin 1): USB Input Supply Pin. Provides power to the battery charger. The maximum supply current is 650mA. This pin should be bypassed with a 1 μ F capacitor.

IUSB (Pin 2): Charge Current Program for USB Power. The charge current is set by connecting a resistor, R_{IUSB}, to ground. When charging in constant-current mode, this pin servos to 1V. The voltage on this pin can be used to measure the battery current delivered from the USB input using the following formula:

$$I_{BAT} = \frac{V_{IUSB}}{R_{IUSB}} \cdot 1000$$

ITERM (Pin 3): Termination Current Threshold Program. The termination current threshold, I_{TERMINATE}, is set by connecting a resistor, R_{ITERM}, to ground. I_{TERMINATE} is set by the following formula:

$$I_{TERMINATE} = \frac{100V}{R_{ITERM}}$$

When the battery current, I_{BAT}, falls below the termination threshold, charging stops and the $\overline{\text{CHRG}}$ output becomes high impedance.

This pin is internally clamped to approximately 1.5V. Driving this pin to voltages beyond the clamp voltage can draw large currents and should be avoided.

$\overline{\text{PWR}}$ (Pin 4): Open-Drain Power Supply Status Output. When the DCIN or USBIN pin voltage is sufficient to begin charging (i.e. when the supply is greater than the under-voltage lockout threshold and at least 180mV above the battery terminal), the $\overline{\text{PWR}}$ pin is pulled low by an internal N-channel MOSFET. Otherwise $\overline{\text{PWR}}$ is high impedance. This output is capable of sinking up to 10mA, making it suitable for driving an LED.

$\overline{\text{CHRG}}$ (Pin 5): Open-Drain Charge Status Output. When the LTC4075 is charging, the $\overline{\text{CHRG}}$ pin is pulled low by an internal N-channel MOSFET. When the charge cycle is completed, $\overline{\text{CHRG}}$ becomes high impedance. This output

is capable of sinking up to 10mA, making it suitable for driving an LED.

ENABLE (Pin 6): Enable Input. When the LTC4075 is charging from the DCIN source, a logic low on this pin enables the charger. When the LTC4075 is charging from the USBIN source, a logic high on this pin enables the charger. If this input is left floating, an internal 2M Ω pulldown resistor defaults the LTC4075 to charge when a wall adapter is applied and to shut down if only the USB source is applied.

USBPWR (Pin 7): Open-Drain USB Power Status Output. When the voltage on the USBIN pin is sufficient to begin charging and there is insufficient power at DCIN, the USB-PWR pin is high impedance. In all other cases, this pin is pulled low by an internal N-channel MOSFET, provided that there is power present at the DCIN, USBIN, or BAT inputs. This output is capable of sinking up to 1mA, making it suitable for driving high impedance logic inputs.

IDC (Pin 8): Charge Current Program for Wall Adapter Power. The charge current is set by connecting a resistor, R_{IDC}, to ground. When charging in constant-current mode, this pin servos to 1V. The voltage on this pin can be used to measure the battery current delivered from the DC input using the following formula:

$$I_{BAT} = \frac{V_{IDC}}{R_{IDC}} \cdot 1000$$

BAT (Pin 9): Charger Output and Regulator Input. This pin provides charge current to the battery and regulates the final float voltage to 4.2V.

DCIN (Pin 10): Wall Adapter Input Supply Pin. Provides power to the battery charger. The maximum supply current is 950mA. This should be bypassed with a 1 μ F capacitor.

Exposed Pad (Pin 11): GND. The exposed backside of the package is ground and must be soldered to PC board ground for electrical connection and maximum heat transfer.

BLOCK DIAGRAM

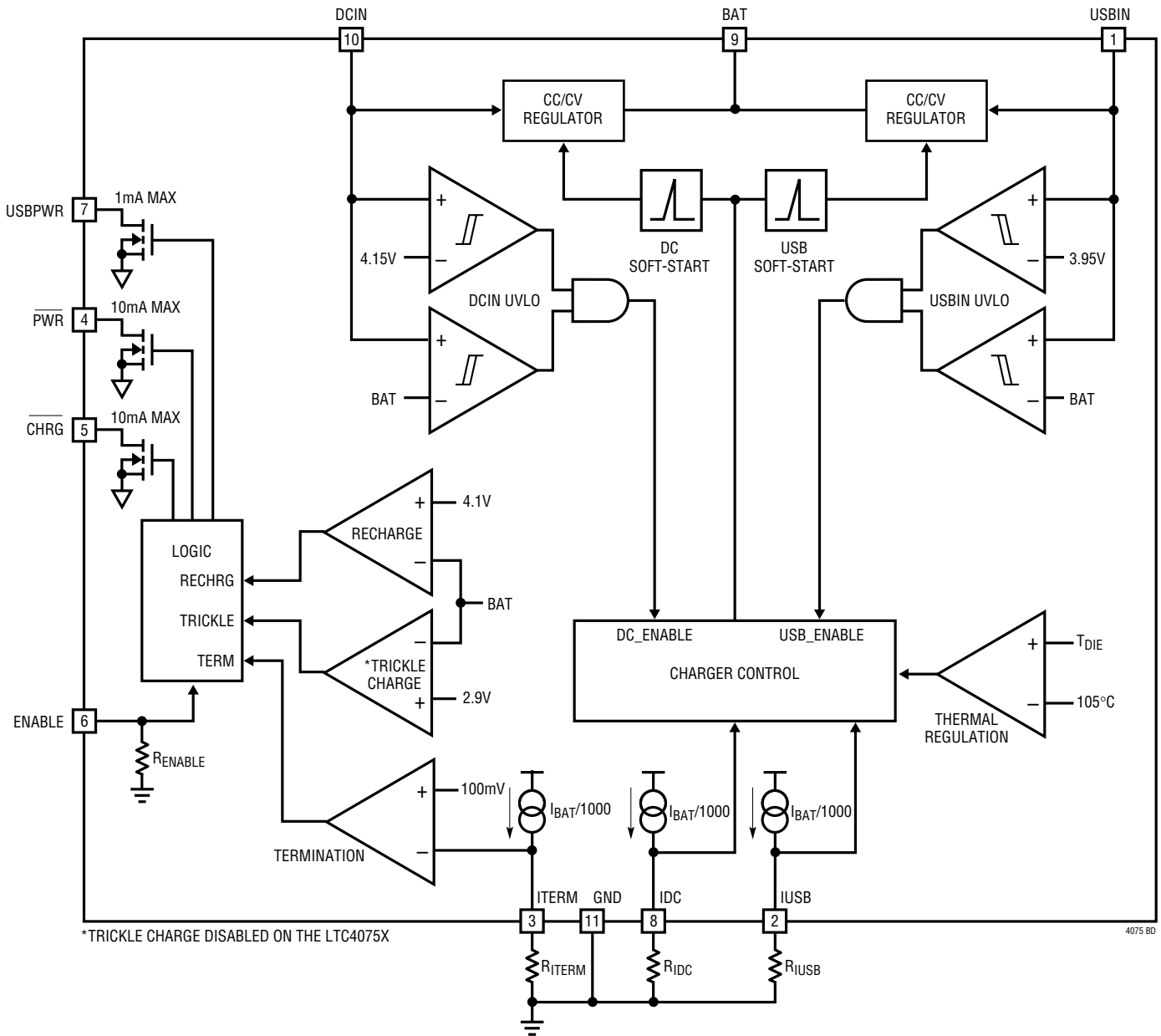

OPERATION

The LTC4075 is designed to efficiently manage charging of a single-cell lithium-ion battery from two separate power sources: a wall adapter and USB power bus. Using the constant-current/constant-voltage algorithm, the charger can deliver up to 950mA of charge current from the wall adapter supply or up to 650mA of charge current from the USB supply with a final float voltage accuracy of $\pm 0.6\%$. The LTC4075 has two internal P-channel power MOSFETs and thermal regulation circuitry. No blocking diodes or external sense resistors are required.

Power Source Selection

The LTC4075 can charge a battery from either the wall adapter input or the USB port input. The LTC4075 automatically senses the presence of voltage at each input. If both power sources are present, the LTC4075 defaults to the wall adapter source provided sufficient power is present at the DCIN input. “Sufficient power” is defined as:

- Supply voltage is greater than the UVLO threshold.
- Supply voltage is greater than the battery voltage by 50mV (180mV rising, 50mV falling).

The open drain power status outputs ($\overline{\text{PWR}}$ and $\overline{\text{USBPWR}}$) indicate which power source has been selected. Table 1 describes the behavior of these status outputs.

Table 1. Power Source Selection

	$V_{\text{USBIN}} > 3.95\text{V}$ and $V_{\text{USBIN}} > \text{BAT} + 50\text{mV}$	$V_{\text{USBIN}} < 3.95\text{V}$ or $V_{\text{USBIN}} < \text{BAT} + 50\text{mV}$
$V_{\text{DCIN}} > 4.15\text{V}$ and $V_{\text{DCIN}} > \text{BAT} + 50\text{mV}$	Device powered from wall adapter source; USBIN current $< 25\mu\text{A}$ $\overline{\text{PWR}}$: LOW USBPWR: LOW	Device powered from wall adapter source $\overline{\text{PWR}}$: LOW USBPWR: LOW
$V_{\text{DCIN}} < 4.15\text{V}$ or $V_{\text{DCIN}} < \text{BAT} + 50\text{mV}$	Device powered from USB source; $\overline{\text{PWR}}$: LOW USBPWR: Hi-Z	No charging $\overline{\text{PWR}}$: Hi-Z USBPWR: LOW

Programming and Monitoring Charge Current

The charge current delivered to the battery from the wall adapter supply is programmed using a single resistor from the IDC pin to ground. Likewise, the charge current from the USB supply is programmed using a single resistor from the IUSB pin to ground. The program resistor and the charge current (I_{CHRG}) are calculated using the following equations:

$$R_{\text{IDC}} = \frac{1000\text{V}}{I_{\text{CHRG-DC}}}, I_{\text{CHRG-DC}} = \frac{1000\text{V}}{R_{\text{IDC}}}$$

$$R_{\text{IUSB}} = \frac{1000\text{V}}{I_{\text{CHRG-USB}}}, I_{\text{CHRG-USB}} = \frac{1000\text{V}}{R_{\text{IUSB}}}$$

Charge current out of the BAT pin can be determined at any time by monitoring the IDC or IUSB pin voltage and using the following equations:

$$I_{\text{BAT}} = \frac{V_{\text{IDC}}}{R_{\text{IDC}}} \cdot 1000, \text{ (charging from wall adapter)}$$

$$I_{\text{BAT}} = \frac{V_{\text{IUSB}}}{R_{\text{IUSB}}} \cdot 1000, \text{ (charging from USB supply)}$$

Programming Charge Termination

The charge cycle terminates when the charge current falls below the programmed termination threshold during constant-voltage mode. This threshold is set by connecting an external resistor, R_{ITERM} , from the ITERM pin to ground. The charge termination current threshold ($I_{\text{TERMINATE}}$) is set by the following equation:

$$R_{\text{ITERM}} = \frac{100\text{V}}{I_{\text{TERMINATE}}}, I_{\text{TERMINATE}} = \frac{100\text{V}}{R_{\text{ITERM}}}$$

OPERATION

The termination condition is detected by using an internal filtered comparator to monitor the ITERM pin. When the ITERM pin voltage drops below 100mV* for longer than $t_{\text{TERMINATE}}$ (typically 1.5ms), charging is terminated. The charge current is latched off and the LTC4075 enters standby mode.

When charging, transient loads on the BAT pin can cause the ITERM pin to fall below 100mV for short periods of time before the DC charge current has dropped below the programmed termination current. The 1.5ms filter time ($t_{\text{TERMINATE}}$) on the termination comparator ensures that transient loads of this nature do not result in premature charge cycle termination. Once the *average* charge current drops below the programmed termination threshold, the LTC4075 terminates the charge cycle and ceases to provide any current out of the BAT pin. In this state, any load on the BAT pin must be supplied by the battery.

Low Battery Charge Conditioning (Trickle Charge)

This feature ensures that near-dead batteries are gradually charged before reapplying full charge current. If the BAT pin voltage is below 2.9V, the LTC4075 supplies 1/10th of the full charge current to the battery until the BAT pin rises back above 2.9V. For example, if the charger is programmed to charge at 800mA from the wall adapter input and 500mA from the USB input, the charge current during trickle charge mode would be 80mA and 50mA, respectively.

The LTC4075X does not include the trickle charge feature; it outputs full charge current to the battery when the BAT pin voltage is below 2.9V. The LTC4075X is useful in applications where the trickle charge current may be insufficient to supply the load during low battery voltage conditions.

Automatic Recharge

In standby mode, the charger sits idle and monitors the battery voltage using a comparator with a 6ms filter time (t_{RECHRG}). A charge cycle automatically restarts when the battery voltage falls below 4.1V (which corresponds to approximately 80%-90% battery capacity). This ensures that the battery is kept at, or near, a fully charged condi-

tion and eliminates the need for periodic charge cycle initiations.

If the battery is removed from the charger, a sawtooth waveform of approximately 100mV appears at the battery output. This is caused by the repeated cycling between termination and recharge events. This cycling results in pulsing at the CHRG output; an LED connected to this pin will exhibit a blinking pattern, indicating to the user that a battery is not present. The frequency of the sawtooth is dependent on the amount of output capacitance.

Manual Shutdown

The ENABLE pin has a 2M Ω pulldown resistor to GND. The definition of this pin depends on which source is supplying power. When the wall adapter input is supplying power, logic low enables the charger and logic high disables it (the pulldown defaults the charger to the charging state). The opposite is true when the USB input is supplying power; logic high disables the charger and logic high enables it (the default is the shutdown state).

The DCIN input draws 20 μ A when the charger is in shutdown. The USBIN input draws 18 μ A during shutdown if no power is applied to DCIN, but draws only 10 μ A when $V_{\text{DCIN}} > V_{\text{USBIN}}$.

Charge Current Soft-Start and Soft-Stop

The LTC4075 includes a soft-start circuit to minimize the inrush current at the start of a charge cycle. When a charge cycle is initiated, the charge current ramps from zero to full-scale current over a period of 250 μ s. Likewise, internal circuitry slowly ramps the charge current from full-scale to zero in a period of approximately 30 μ s when the charger shuts down or self terminates. This minimizes the transient current load on the power supply during start-up and shut-off.

Status Indicators

The charge status output ($\overline{\text{CHRG}}$) has two states: pull-down and high impedance. The pull-down state indicates that the LTC4075 is in a charge cycle. Once the charge cycle has terminated or the LTC4075 is disabled, the pin state becomes high impedance. The pull-down state is capable of sinking up to 10mA.

*Any external sources that hold the ITERM pin above 100mV will prevent the LTC4075 from terminating a charge cycle.

OPERATION

The power supply status output (\overline{PWR}) has two states: pull-down and high impedance. The pull-down state indicates that power is present at either DCIN or USBIN. This output is strong enough to drive an LED. If no power is applied at either pin, the \overline{PWR} pin is high impedance, indicating that the LTC4075 lacks sufficient power to charge the battery. The pull-down state is capable of sinking up to 10mA.

The USB power status output (USBPWR) has two states: pull-down and high impedance. The high impedance state indicates that the LTC4075 is being powered from the USBIN input. The pull-down state indicates that the charger is either powered from DCIN or is in a UVLO condition (see Table 1). The pull-down state is capable of sinking up to 1mA.

Thermal Limiting

An internal thermal feedback loop reduces the programmed charge current if the die temperature attempts to rise above a preset value of approximately 105°C. This feature protects the LTC4075 from excessive temperature and allows the user to push the limits of the power handling capability of a given circuit board without risk of damaging the device. The charge current can be set according to typical (not worst-case) ambient temperature with the assurance that the charger will automatically reduce the current in worst-case conditions. DFN power considerations are discussed further in the Applications Information section.

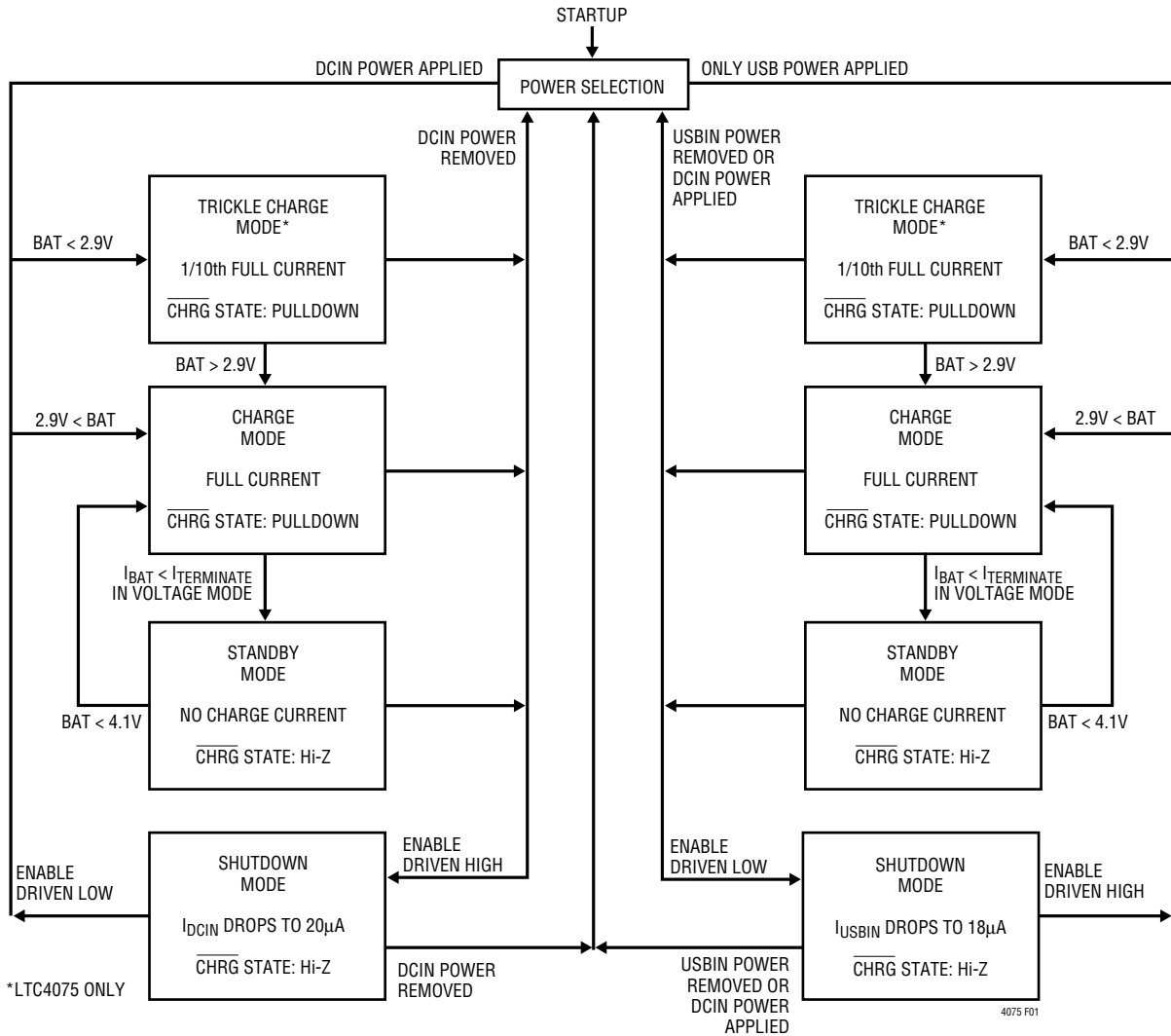

Figure 1. LTC4075 State Diagram of a Charge Cycle

APPLICATIONS INFORMATION

Using a Single Charge Current Program Resistor

The LTC4075 can program the wall adapter charge current and USB charge current independently using two program resistors, R_{IDC} and R_{IUSB} . Figure 2 shows a charger circuit that sets the wall adapter charge current to 800mA and the USB charge current to 500mA.

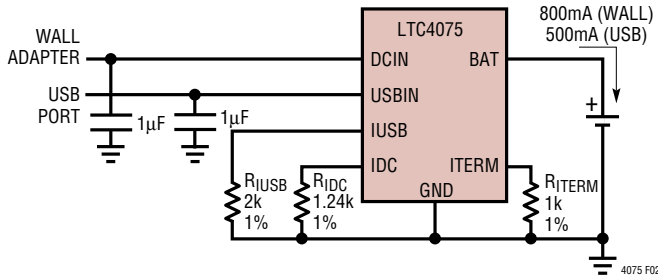

Figure 2. Full Featured Dual Input Charger Circuit

In applications where the programmed wall adapter charge current and USB charge current are the same, a single program resistor can be used to set both charge currents. Figure 3 shows a charger circuit that uses one charge current program resistor.

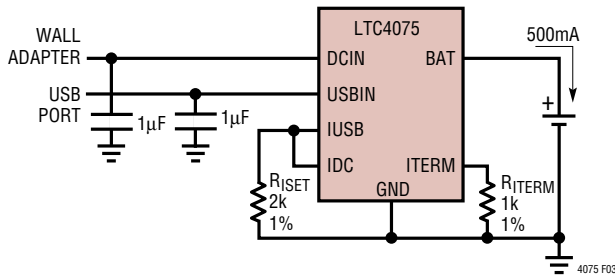

Figure 3. Dual Input Charger Circuit. The Wall Adapter Charge Current and USB Charge Current are Both Programmed to be 500mA

In this circuit, the programmed charge current from both the wall adapter supply is the same value as the programmed charge current from the USB supply:

$$I_{\text{CHRG-DC}} = I_{\text{CHRG-USB}} = \frac{1000V}{R_{\text{ISET}}}$$

Stability Considerations

The constant-voltage mode feedback loop is stable without any compensation provided a battery is connected to the charger output. However, a 1µF capacitor with a 1Ω series resistor is recommended at the BAT pin to keep the ripple voltage low when the battery is disconnected.

When the charger is in constant-current mode, the charge current program pin (IDC or IUSB) is in the feedback loop, not the battery. The constant-current mode stability is affected by the impedance at the charge current program pin. With no additional capacitance on this pin, the charger is stable with program resistor values as high as 20k ($I_{\text{CHRG}} = 50\text{mA}$); however, additional capacitance on these nodes reduces the maximum allowed program resistor.

Power Dissipation

When designing the battery charger circuit, it is not necessary to design for worst-case power dissipation scenarios because the LTC4075 automatically reduces the charge current during high power conditions. The conditions that cause the LTC4075 to reduce charge current through thermal feedback can be approximated by considering the power dissipated in the IC. Most of the power dissipation is generated from the internal charger MOSFET. Thus, the power dissipation is calculated to be:

$$P_D = (V_{\text{IN}} - V_{\text{BAT}}) \cdot I_{\text{BAT}}$$

APPLICATIONS INFORMATION

P_D is the power dissipated, V_{IN} is the input supply voltage (either DCIN or USBIN), V_{BAT} is the battery voltage and I_{BAT} is the charge current. The approximate ambient temperature at which the thermal feedback begins to protect the IC is:

$$T_A = 105^\circ\text{C} - P_D \cdot \theta_{JA}$$

$$T_A = 105^\circ\text{C} - (V_{IN} - V_{BAT}) \cdot I_{BAT} \cdot \theta_{JA}$$

Example: An LTC4075 operating from a 5V wall adapter (on the DCIN input) is programmed to supply 800mA full-scale current to a discharged Li-Ion battery with a voltage of 3.3V. Assuming θ_{JA} is $40^\circ\text{C}/\text{W}$ (see Thermal Considerations), the ambient temperature at which the LTC4075 will begin to reduce the charge current is approximately:

$$T_A = 105^\circ\text{C} - (5\text{V} - 3.3\text{V}) \cdot (800\text{mA}) \cdot 40^\circ\text{C}/\text{W}$$

$$T_A = 105^\circ\text{C} - 1.36\text{W} \cdot 40^\circ\text{C}/\text{W} = 105^\circ\text{C} - 54.4^\circ\text{C}$$

$$T_A = 50.6^\circ\text{C}$$

The LTC4075 can be used above 50.6°C ambient, but the charge current will be reduced from 800mA. The approximate current at a given ambient temperature can be approximated by:

$$I_{BAT} = \frac{105^\circ\text{C} - T_A}{(V_{IN} - V_{BAT}) \cdot \theta_{JA}}$$

Using the previous example with an ambient temperature of 60°C , the charge current will be reduced to approximately:

$$I_{BAT} = \frac{105^\circ\text{C} - 60^\circ\text{C}}{(5\text{V} - 3.3\text{V}) \cdot 40^\circ\text{C}/\text{W}} = \frac{45^\circ\text{C}}{68^\circ\text{C}/\text{A}}$$

$$I_{BAT} = 662\text{mA}$$

It is important to remember that LTC4075 applications do not need to be designed for worst-case thermal conditions, since the IC will automatically reduce power dissipation when the junction temperature reaches approximately 105°C .

Thermal Considerations

In order to deliver maximum charge current under all conditions, it is critical that the exposed metal pad on the backside of the LTC4075 package is properly soldered to the PC board ground. When correctly soldered to a 2500mm^2 double sided 1oz copper board, the LTC4075 has a thermal resistance of approximately $40^\circ\text{C}/\text{W}$. Failure to make thermal contact between the exposed pad on the backside of the package and the copper board will result in thermal resistances far greater than $40^\circ\text{C}/\text{W}$. As an example, a correctly soldered LTC4075 can deliver over 800mA to a battery from a 5V supply at room temperature. Without a good backside thermal connection, this number would drop to much less than 500mA.

Protecting the USB Pin and Wall Adapter Input from Overvoltage Transients

Caution must be exercised when using ceramic capacitors to bypass the USBIN pin or the wall adapter inputs. High voltage transients can be generated when the USB or wall adapter is hot plugged. When power is supplied via the USB bus or wall adapter, the cable inductance along with the self resonant and high Q characteristics of ceramic capacitors can cause substantial ringing which could exceed the maximum voltage pin ratings and damage the LTC4075. Refer to Linear Technology Application Note 88, entitled "Ceramic Input Capacitors Can Cause Overvoltage Transients" for a detailed discussion of this problem. The long cable lengths of most wall adapters and USB cables

APPLICATIONS INFORMATION

makes them especially susceptible to this problem. To bypass the USB pin and the wall adapter input, add a 1Ω resistor in series with a ceramic capacitor to lower the effective Q of the network and greatly reduce the ringing. A tantalum, OS-CON, or electrolytic capacitor can be used in place of the ceramic and resistor, as their higher ESR reduces the Q, thus reducing the voltage ringing.

The oscilloscope photograph in Figure 4 shows how serious the overvoltage transient can be for the USB and wall adapter inputs. For both traces, a 5V supply is hot-plugged using a three foot long cable. For the top trace, only a $4.7\mu\text{F}$ capacitor (without the recommended 1Ω series resistor) is used to locally bypass the input. This trace shows excessive ringing when the 5V cable is inserted, with the overvoltage spike reaching 10V. For the bottom trace, a 1Ω resistor is added in series with the $4.7\mu\text{F}$ capacitor to locally bypass the 5V input. This trace shows the clean response resulting from the addition of the 1Ω resistor.

Even with the additional 1Ω resistor, bad design techniques and poor board layout can often make the overvoltage

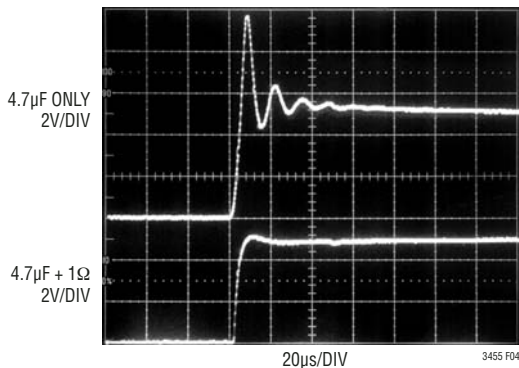

Figure 4. Waveforms Resulting from Hot-Plugging a 5V Input Supply

problem even worse. System designers often add extra inductance in series with input lines in an attempt to minimize the noise fed back to those inputs by the application. In reality, adding these extra inductances only makes the overvoltage transients worse. Since cable inductance is one of the fundamental causes of the excessive ringing, adding a series ferrite bead or inductor increases the effective cable inductance, making the problem even worse. For this reason, **do not** add additional inductance (ferrite beads or inductors) in series with the USB or wall adapter inputs. For the most robust solution, 6V transorbs or zener diodes may also be added to further protect the USB and wall adapter inputs. Two possible protection devices are the SM2T from STMicroelectronics and the EDZ series devices from ROHM.

Always use an oscilloscope to check the voltage waveforms at the USBIN and DCIN pins during USB and wall adapter hot-plug events to ensure that overvoltage transients have been adequately removed.

Reverse Polarity Input Voltage Protection

In some applications, protection from reverse polarity voltage on the input supply pins is desired. If the supply voltage is high enough, a series blocking diode can be used. In other cases where the voltage drop must be kept low, a P-channel MOSFET can be used (as shown in Figure 5).

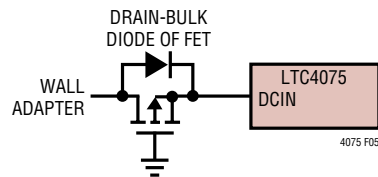
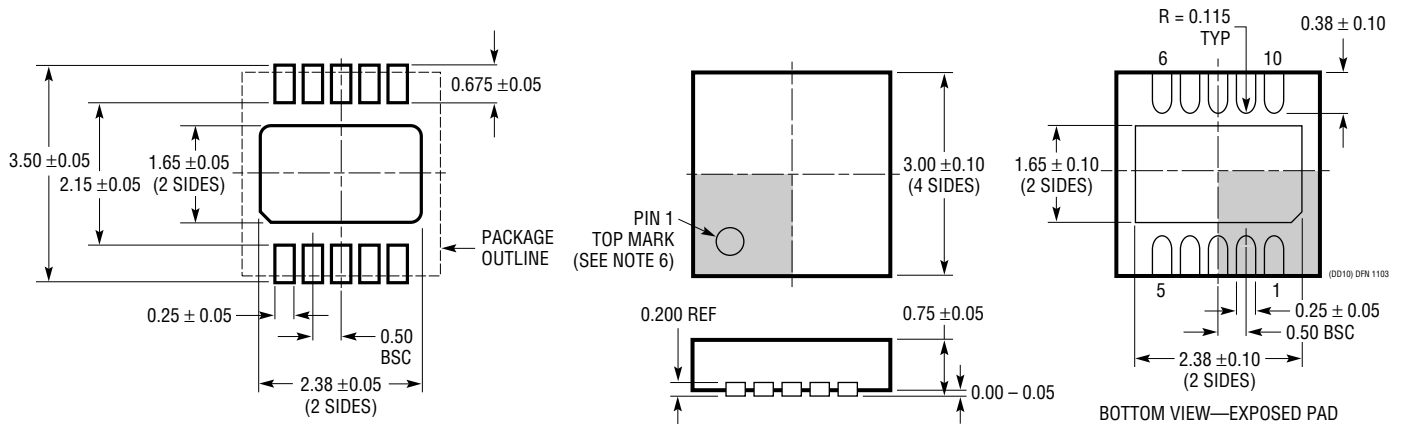

Figure 5. Low Loss Input Reverse Polarity Protection

PACKAGE DESCRIPTION

DD Package 10-Lead Plastic DFN (3mm × 3mm) (Reference LTC DWG # 05-08-1699)



RECOMMENDED SOLDER PAD PITCH AND DIMENSIONS

NOTE:

1. DRAWING TO BE MADE A JEDEC PACKAGE OUTLINE M0-229 VARIATION OF (WEED-2). CHECK THE LTC WEBSITE DATA SHEET FOR CURRENT STATUS OF VARIATION ASSIGNMENT
2. DRAWING NOT TO SCALE
3. ALL DIMENSIONS ARE IN MILLIMETERS
4. DIMENSIONS OF EXPOSED PAD ON BOTTOM OF PACKAGE DO NOT INCLUDE MOLD FLASH. MOLD FLASH, IF PRESENT, SHALL NOT EXCEED 0.15mm ON ANY SIDE
5. EXPOSED PAD SHALL BE SOLDER PLATED
6. SHADED AREA IS ONLY A REFERENCE FOR PIN 1 LOCATION ON THE TOP AND BOTTOM OF PACKAGE

TYPICAL APPLICATION

Full Featured Li-Ion Charger

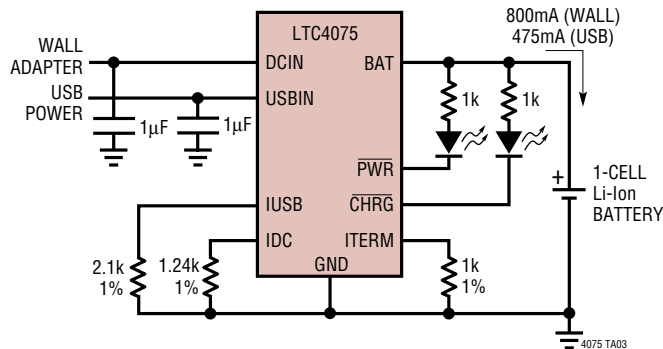

RELATED PARTS

PART NUMBER	DESCRIPTION	COMMENTS
LTC3455	Dual DC/DC Converter with USB Power Management and Li-Ion Battery Charger	Efficiency >96%, Accurate USB Current Limiting (500mA/100mA), 4mm × 4mm QFN-24 Package
LTC4053	USB Compatible Monolithic Li-Ion Battery Charger	Standalone Charger with Programmable Timer, Up to 1.25A Charge Current
LTC4054/LTC4054X	Standalone Linear Li-Ion Battery Charger with Integrated Pass Transistor in ThinSOT	Thermal Regulation Prevents Overheating, C/10 Termination, C/10 Indicator, Up to 800mA Charge Current
LTC4055	USB Power Controller and Battery Charger	Charges Single-Cell Li-Ion Batteries Directly from USB Port, Thermal Regulation, 4mm × 4mm QFN-16 Package
LTC4058/LTC4058X	Standalone 950mA Lithium-Ion Charger in DFN	C/10 Charge Termination, Battery Kelvin Sensing, ±7% Charge Accuracy
LTC4061	Standalone Li-Ion Charger with Thermistor Interface	4.2V, ±0.35% Float Voltage, Up to 1A Charge Current
LTC4066	USB Power Controller and Li-Ion Linear Battery Charger with Low-Loss Ideal Diode	Seamless Transition Between Input Power Sources: Li-Ion Battery, USB and Wall Adapter, Low-Loss (50Ω) Ideal Diode, 4mm × 4mm QFN-24 Package
LTC4068/LTC4068X	Standalone Linear Li-Ion Battery Charger with Programmable Termination	Charge Current up to 950mA, Thermal Regulation, 3mm × 3mm DFN-8 Package
LTC4410	USB Power Manager and Battery Charger	Manages Total Power Between a USB Peripheral and Battery Charger, Ultralow Battery Drain: 1µA, ThinSOT™ Package
LTC4411/LTC4412	Low Loss PowerPath™ Controller in ThinSOT	Automatic Switching Between DC Sources, Load Sharing, Replaces ORing Diodes

ThinSOT and PowerPath are trademarks of Linear Technology Corporation