

|              |   |                   |
|--------------|---|-------------------|
| <b>SANYO</b> | No. 5249  | <b>STK401-250</b> |
|              | <b>2ch AF Power Amplifier (Split Power Supply)</b><br><b>30W + 30W, THD = 0.08%</b> |                   |

### Overview

The STK401-250 is a 2-channel audio power amplifier IC that supports  $6/3\Omega$  output load impedances. It is fully pin compatible with the 3-channel output devices (STK400-x00 series) and 2-channel output devices (STK401-x00 series). In addition, it supports  $6/3\Omega$  output load impedance.

### Features

- Pin compatible with the 3-channel output devices (STK400-x00 series) and 2-channel output devices (STK401-x00 series)
- Output load impedance  $R_L = 6/3\Omega$  supported
- Pin configuration grouped into individual blocks of inputs, outputs and supply lines to minimize the adverse effects of pattern layout on operating characteristics.
- Few external components

### Package Dimensions

unit: mm

4134

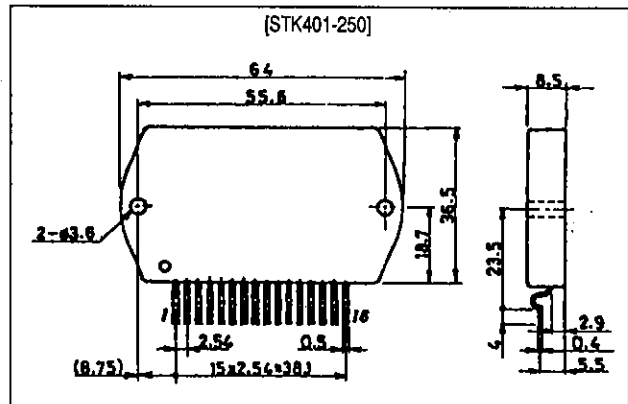

## Specifications

### Maximum Ratings at Ta = 25°C

| Parameter                             | Symbol              | Conditions   | Ratings     | Unit |
|---------------------------------------|---------------------|--|-------------|------|
| Maximum supply voltage                | V <sub>CC</sub> max |  | ±39         | V    |
| Thermal resistance                    | θ <sub>j-c</sub>    | Per power transistor   | 1.8         | °C/W |
| Junction temperature                  | T <sub>J</sub>      |  | 150         | °C   |
| Operating substrate temperature       | T <sub>c</sub>      |  | 125         | °C   |
| Storage temperature                   | T <sub>stg</sub>    |  | -30 to +125 | °C   |
| Available time for load short-circuit | t <sub>s</sub>      | V <sub>CC</sub> = ±26V, R <sub>L</sub> = 6Ω,<br>f = 50Hz, P <sub>O</sub> = 30W | 1           | s    |

### Operating Characteristics at Ta = 25°C, R<sub>L</sub> = 6Ω (noninductive load), R<sub>g</sub> = 600Ω, V<sub>G</sub> = 40dB

| Parameter                 | Symbol                          | Conditions  | min | typ       | max  | Unit  |
|---------------------------|---------------------------------|---|-----|-----------|------|-------|
| Output power              | P <sub>O</sub> (1)              | V <sub>CC</sub> = ±26V, f = 20Hz to 20kHz, THD = 0.08%                          | 30  | 35        | -    | W     |
|                           | P <sub>O</sub> (2)              | V <sub>CC</sub> = ±22V, f = 1kHz, THD = 0.2%, R <sub>L</sub> = 3Ω               | 30  | 35        | -    | W     |
| Total harmonic distortion | THD(1)                          | V <sub>CC</sub> = ±26V, f = 20Hz to 20kHz, P <sub>O</sub> = 1.0W                | -   | -         | 0.08 | %     |
|                           | THD(2)                          | V <sub>CC</sub> = ±26V, f = 1kHz, P <sub>O</sub> = 5.0W                         | -   | 0.007     | -    | %     |
| Frequency response        | f <sub>L</sub> , f <sub>H</sub> | V <sub>CC</sub> = ±26V, P <sub>O</sub> = 1.0W, <sup>+0</sup> / <sub>-3</sub> dB | -   | 20 to 50k | -    | Hz    |
| Input impedance           | r <sub>i</sub>                  | V <sub>CC</sub> = ±26V, f = 1kHz, P <sub>O</sub> = 1.0W                         | -   | 55        | -    | kΩ    |
| Output noise voltage      | V <sub>NO</sub>                 | V <sub>CC</sub> = ±31V, R <sub>g</sub> = 10kΩ                                   | -   | -         | 1.2  | mVrms |
| Quiescent current         | I <sub>CCO</sub>                | V <sub>CC</sub> = ±31V  | 20  | 60        | 100  | mA    |
| Neutral voltage           | V <sub>N</sub>                  | V <sub>CC</sub> = ±31V  | -70 | 0         | +70  | mV    |

**Notes.**

All tests are measured using a constant-voltage supply unless otherwise specified.

Available time for load short-circuit and output noise voltage are measured using the transformer supply specified below.

The output noise voltage is the peak value of an average-reading meter with an rms value scale (VTVM). A regulated AC supply (50Hz) should be used to eliminate the effects of AC primary line flicker noise.

### Specified Transformer Supply (RP-25 or Equivalent)

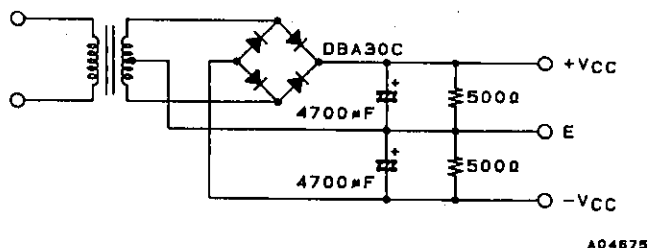

Equivalent Circuit

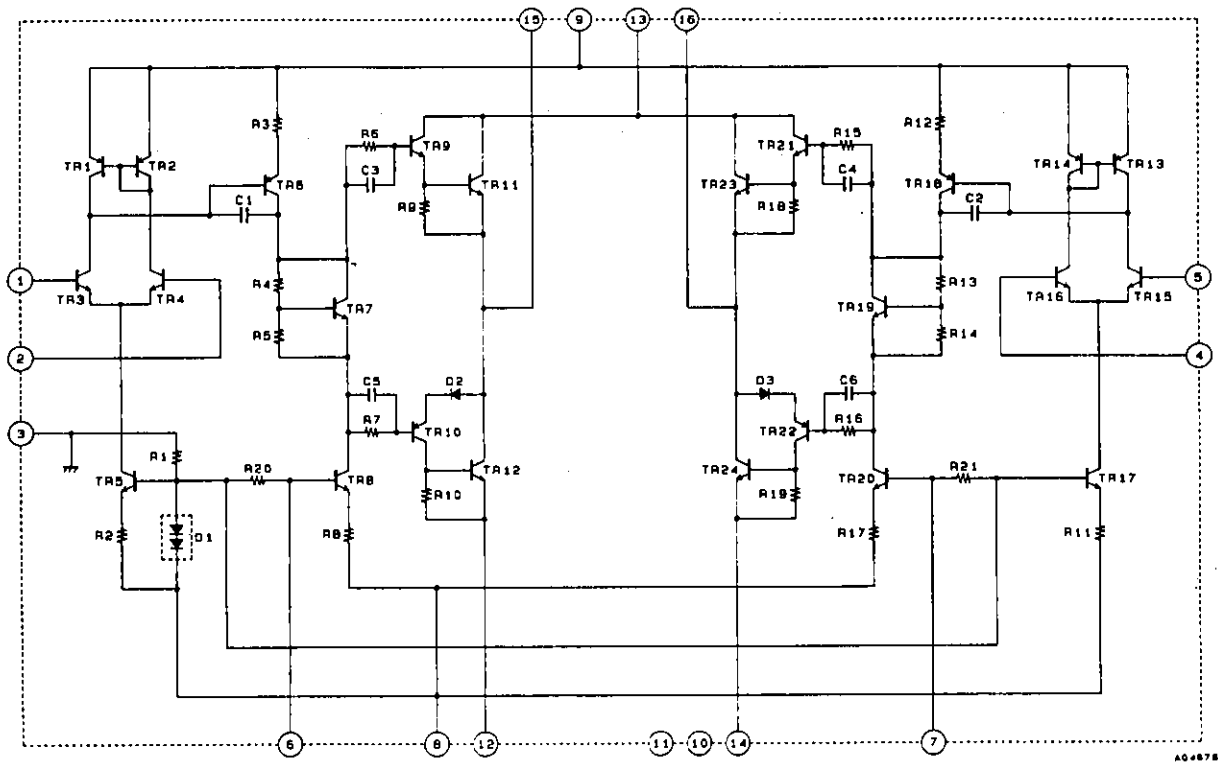

Sample Application Circuit

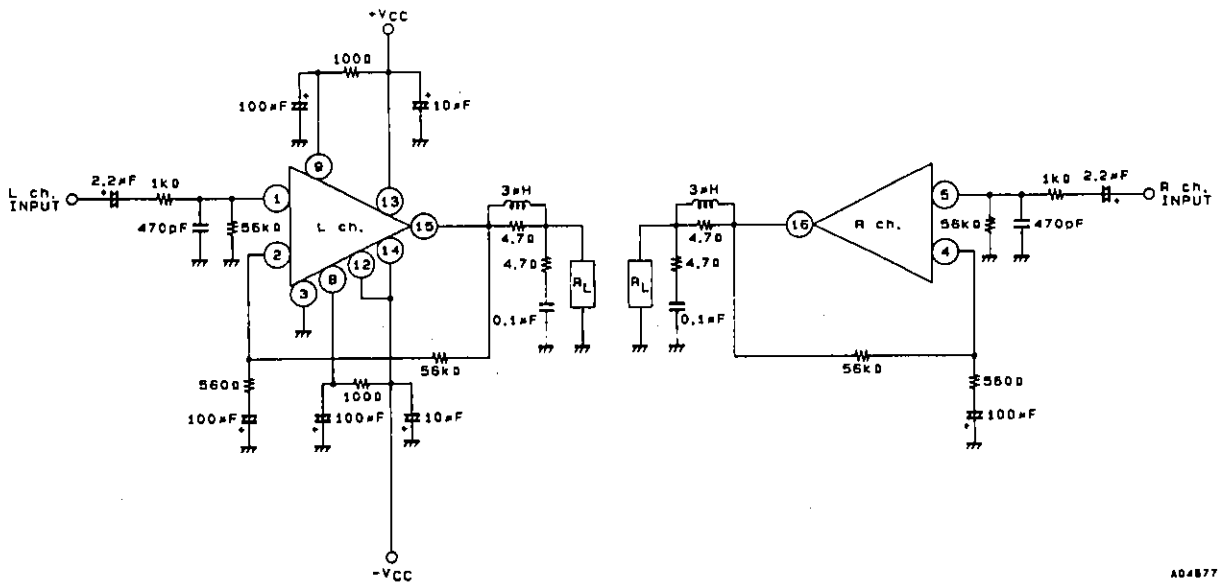

## STK401-250

### Series Configuration

These devices form a series of pin-compatible devices with different number of output channels, output ratings and total harmonic distortion. Some of these devices are under development. Contact your Sanyo sales representative if you require more detailed information.

| STK400-000, STK400-200 series<br>(3-channel, same output rating) |         |            |         |              | STK401-000, STK401-200 series<br>(2-channel) |         |            |         |              | Supply voltage [V] <sup>1</sup> |                      |                   |                   |
|--|---------|------------|---------|--------------|--|---------|------------|---------|--------------|---------------------------------|----------------------|-------------------|-------------------|
| Type No.   | THD [%] | Type No.   | THD [%] | Rated output | Type No.                                     | THD [%] | Type No.   | THD [%] | Rated output | V <sub>CC</sub> max1            | V <sub>CC</sub> max2 | V <sub>CC</sub> 1 | V <sub>CC</sub> 2 |
| STK400-010   | 0.4     | STK400-210 | 0.08    | 10W × 3      | STK401-010                                   | 0.4     | STK401-210 | 0.08    | 10W × 2      | -                               | ±26.0                | ±17.5             | ±14.0             |
| STK400-020   |         | STK400-220 |         | 15W × 3      | STK401-020                                   |         | STK401-220 |         | 15W × 2      | -                               | ±29.0                | ±20.0             | ±16.0             |
| STK400-030   |         | STK400-230 |         | 20W × 3      | STK401-030                                   |         | STK401-230 |         | 20W × 2      | -                               | ±34.0                | ±23.0             | ±19.0             |
| STK400-040   |         | STK400-240 |         | 25W × 3      | STK401-040                                   |         | STK401-240 |         | 25W × 2      | -                               | ±36.0                | ±25.0             | ±21.0             |
| STK400-050   |         | STK400-250 |         | 30W × 3      | STK401-050                                   |         | STK401-250 |         | 30W × 2      | -                               | ±39.0                | ±26.0             | ±22.0             |
| STK400-060   |         | STK400-260 |         | 35W × 3      | STK401-060                                   |         | STK401-260 |         | 35W × 2      | -                               | ±41.0                | ±28.0             | ±23.0             |
| STK400-070   |         | STK400-270 |         | 40W × 3      | STK401-070                                   |         | STK401-270 |         | 40W × 2      | -                               | ±44.0                | ±30.0             | ±24.0             |
| STK400-080   |         | STK400-280 |         | 45W × 3      | STK401-080                                   |         | STK401-280 |         | 45W × 2      | -                               | ±45.0                | ±31.0             | ±25.0             |
| STK400-090   |         | STK400-290 |         | 50W × 3      | STK401-090                                   |         | STK401-290 |         | 50W × 2      | -                               | ±47.0                | ±32.0             | ±26.0             |
| STK400-100   |         | STK400-300 |         | 60W × 3      | STK401-100                                   |         | STK401-300 |         | 60W × 2      | -                               | ±51.0                | ±35.0             | ±27.0             |
| STK400-110   |         | STK400-310 |         | 70W × 3      | STK401-110                                   |         | STK401-310 |         | 70W × 2      | ±56.0                           | -                    | ±38.0             | -                 |
|  |         |            |         |              | STK401-120                                   |         | STK401-320 |         | 80W × 2      | ±61.0                           | -                    | ±42.0             | -                 |
|  |         |            |         |              | STK401-130                                   |         | STK401-330 |         | 100W × 2     | ±65.0                           | -                    | ±45.0             | -                 |
|  |         |            |         |              | STK401-140                                   |         | STK401-340 |         | 120W × 2     | ±74.0                           | -                    | ±51.0             | -                 |

| STK400-400, STK400-600 series<br>(3-channel, different output ratings) |            |            |         |              | Supply voltage [V] <sup>1</sup> |                      |                   |                   |       |
|--|------------|------------|---------|--------------|---------------------------------|----------------------|-------------------|-------------------|-------|
| Type No.   | THD [%]    | Type No.   | THD [%] | Rated output | V <sub>CC</sub> max1            | V <sub>CC</sub> max2 | V <sub>CC</sub> 1 | V <sub>CC</sub> 2 |       |
| STK400-450   | 0.4        | STK400-650 | 0.08    | Cch          | 30W                             | -                    | ±39.0             | ±26.0             | ±22.0 |
|  |            |            |         | Lch, Rch     | 15W                             | -                    | ±29.0             | ±20.0             | ±16.0 |
| STK400-460   |            | STK400-660 |         | Cch          | 35W                             | -                    | ±41.0             | ±28.0             | ±23.0 |
|  |            |            |         | Lch, Rch     | 15W                             | -                    | ±29.0             | ±20.0             | ±16.0 |
| STK400-470   |            | STK400-670 |         | Cch          | 40W                             | -                    | ±44.0             | ±30.0             | ±24.0 |
|  |            |            |         | Lch, Rch     | 20W                             | -                    | ±34.0             | ±23.0             | ±19.0 |
| STK400-480   |            | STK400-680 |         | Cch          | 45W                             | -                    | ±45.0             | ±31.0             | ±25.0 |
|  |            |            |         | Lch, Rch     | 20W                             | -                    | ±34.0             | ±23.0             | ±19.0 |
| STK400-490   |            | STK400-690 |         | Cch          | 50W                             | -                    | ±47.0             | ±32.0             | ±26.0 |
|  |            |            |         | Lch, Rch     | 25W                             | -                    | ±36.0             | ±25.0             | ±21.0 |
| STK400-500   |            | STK400-700 |         | Cch          | 60W                             | -                    | ±51.0             | ±35.0             | ±27.0 |
|  |            |            |         | Lch, Rch     | 30W                             | -                    | ±39.0             | ±26.0             | ±22.0 |
| STK400-510   |            | STK400-710 |         | Cch          | 70W                             | ±56.0                | -                 | ±38.0             | -     |
|  |            |            |         | Lch, Rch     | 35W                             | -                    | ±41.0             | ±28.0             | ±23.0 |
| STK400-520   | STK400-720 | Cch        | 80W     | ±61.0        | -                               | ±42.0                | -                 |                   |       |
|  |            | Lch, Rch   | 40W     | -            | ±44.0                           | ±30.0                | ±24.0             |                   |       |
| STK400-530   | STK400-730 | Cch        | 100W    | ±65.0        | -                               | ±45.0                | -                 |                   |       |
|  |            | Lch, Rch   | 50W     | -            | ±47.0                           | ±32.0                | ±26.0             |                   |       |

1. V<sub>CC</sub> max1 (R<sub>L</sub> = 6Ω), V<sub>CC</sub> max2 (R<sub>L</sub> = 3 to 6Ω), V<sub>CC</sub>1 (R<sub>L</sub> = 6Ω), V<sub>CC</sub>2 (R<sub>L</sub> = 3Ω)

### Heatsink Design Considerations

The heatsink thermal resistance,  $\theta_{c-a}$ , required to dissipate the STK401-250 device total power dissipation,  $P_d$ , is determined as follows:

Condition 1: IC substrate temperature not to exceed 125°C.

$$P_d \times \theta_{c-a} + T_a < 125^\circ\text{C} \dots\dots\dots (1)$$

where  $T_a$  is the guaranteed maximum ambient temperature.

Condition 2: Power transistor junction temperature,  $T_j$ , not to exceed 150°C.

$$P_d \times \theta_{c-a} + P_d/N \times \theta_{j-c} + T_a < 150^\circ\text{C} \dots\dots\dots (2)$$

where  $N$  is the number of power transistors and  $\theta_{j-c}$  is the power transistor thermal resistance per transistor. Note that the power dissipated per transistor is the total,  $P_d$ , divided evenly among the  $N$  power transistors.

Expressions (1) and (2) can be rewritten making  $\theta_{c-a}$  the subject.

$$\theta_{c-a} < (125 - T_a)/P_d \dots\dots\dots (1)'$$

$$\theta_{c-a} < (150 - T_a)/P_d - \theta_{j-c}/N \dots\dots\dots (2)'$$

The heatsink required must have a thermal resistance that simultaneously satisfies both expressions.

The heatsink thermal resistance can be determined from (1)' and (2)' once the following parameters have been defined.

- Supply voltage:  $V_{CC}$
- Load resistance:  $R_L$
- Guaranteed maximum ambient temperature:  $T_a$

The total device power dissipation when STK401-250  $V_{CC} = \pm 26\text{V}$  and  $R_L = 6\Omega$ , for a continuous sine wave signal, is a maximum of 45.7W, as shown in the  $P_d - P_O$  graphs.

When estimating the power dissipation for an actual audio signal input, the rule of thumb is to select  $P_d$  corresponding to  $(1/10) \times P_O \text{ max}$  (within safe limits) for a continuous sine wave input. For example,

$$P_d = 27.7\text{W [for } (1/10) \times P_O \text{ max} = 3\text{W]}$$

The STK401-250 has 4 power transistors, and the thermal resistance per transistor,  $\theta_{j-c}$ , is 1.8°C/W. If the guaranteed maximum ambient temperature,  $T_a$ , is 50°C, then the required heatsink thermal resistance,  $\theta_{c-a}$ , is:

$$\text{From expression (1)'}: \theta_{c-a} < (125 - 50)/27.7 < 2.70$$

$$\text{From expression (2)'}: \theta_{c-a} < (150 - 50)/27.7 - 1.8/4 < 3.16$$

Therefore, to satisfy both expressions, the required heatsink must have a thermal resistance less than 2.70°C/W.

Similarly, when STK401-250  $V_{CC} = \pm 22\text{V}$  and  $R_L = 3\Omega$ ,

$$P_d = 33.5\text{W [for } (1/10) \times P_O \text{ max} = 3\text{W]}$$

$$\text{From expression (1)'}: \theta_{c-a} < (125 - 50)/33.5 < 2.23$$

$$\text{From expression (2)'}: \theta_{c-a} < (150 - 50)/33.5 - 1.8/4 < 2.53$$

Therefore, to satisfy both expressions, the required heatsink must have a thermal resistance less than 2.23°C/W.

This heatsink design example is based on a constant-voltage supply, and should be verified within your specific set environment.

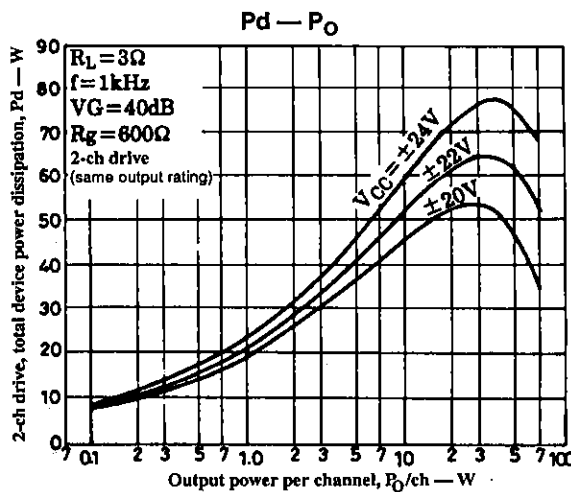
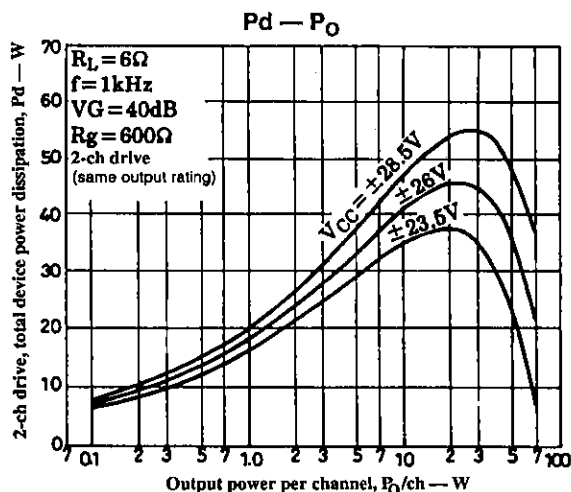

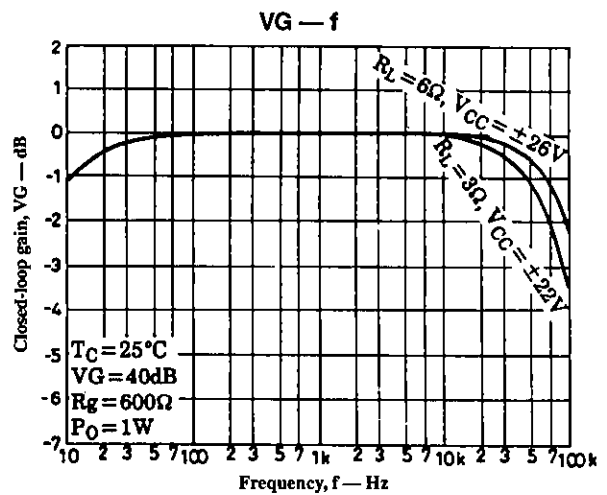
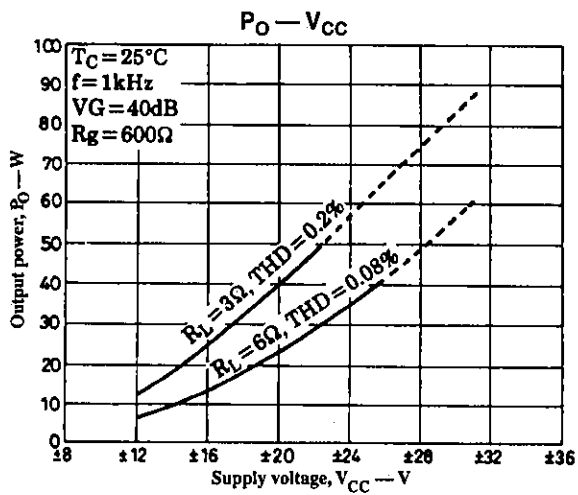
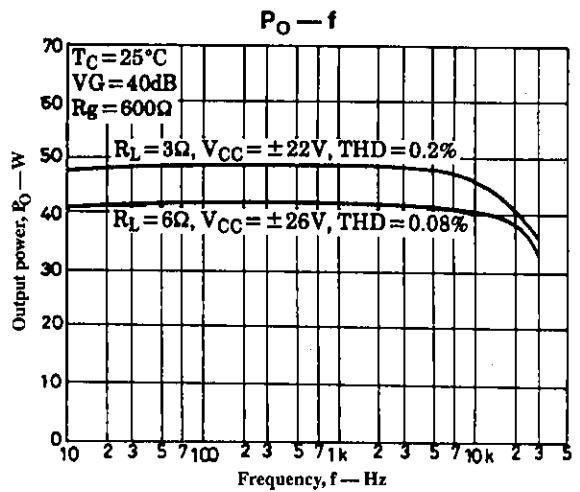
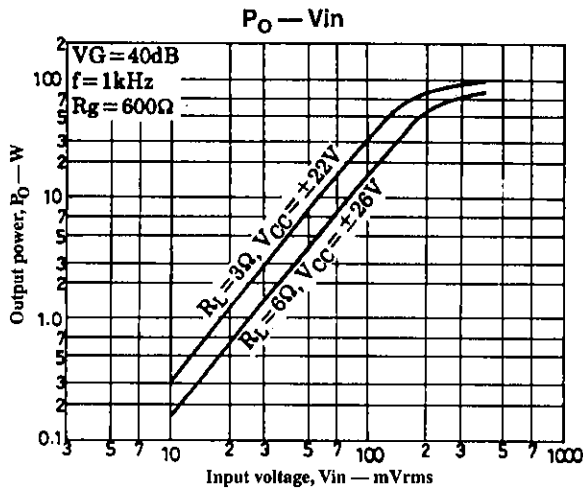
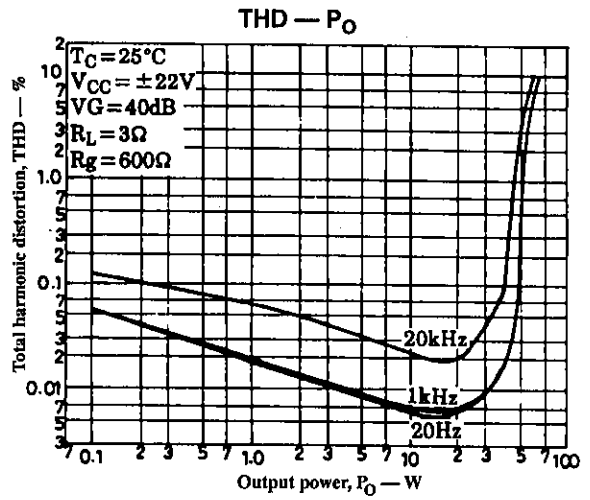
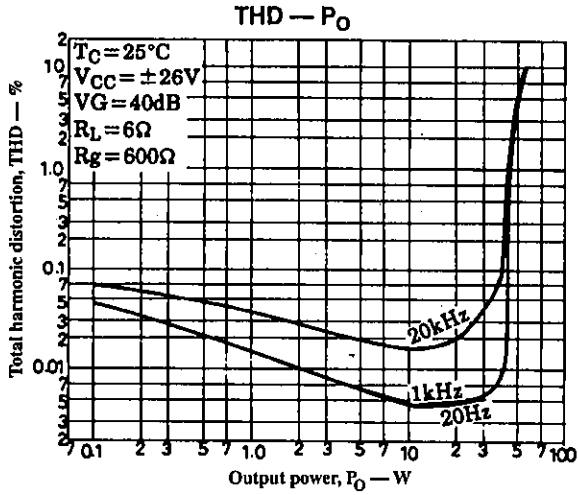

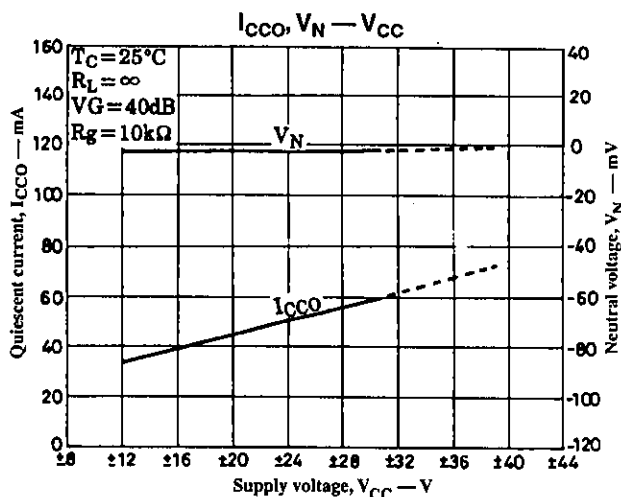
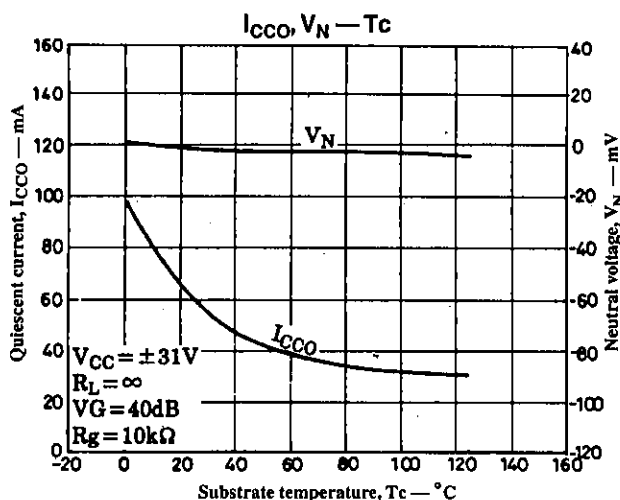

- No products described or contained herein are intended for use in surgical implants, life-support systems, aerospace equipment, nuclear power control systems, vehicles, disaster/crime-prevention equipment and the like, the failure of which may directly or indirectly cause injury, death or property loss.
- Anyone purchasing any products described or contained herein for an above-mentioned use shall:
  - ① Accept full responsibility and indemnify and defend SANYO ELECTRIC CO., LTD., its affiliates, subsidiaries and distributors and all their officers and employees, jointly and severally, against any and all claims and litigation and all damages, cost and expenses associated with such use;
  - ② Not impose any responsibility for any fault or negligence which may be cited in any such claim or litigation on SANYO ELECTRIC CO., LTD., its affiliates, subsidiaries and distributors or any of their officers and employees, jointly or severally.
- Information (including circuit diagrams and circuit parameters) herein is for example only; it is not guaranteed for volume production. SANYO believes information herein is accurate and reliable, but no guarantees are made or implied regarding its use or any infringements of intellectual property rights or other rights of third parties.

This catalog provides information as of December, 1995. Specifications and information herein are subject to change without notice.