



1V HIGH EFFICIENCY SYNCHRONOUS STEP UP CONVERTER

- 0.6 TO 5.5V OPERATING INPUT VOLTAGE
- 1V START UP INPUT VOLTAGE
- INTERNAL SYNCHRONOUS RECTIFIER
- ZERO SHUT DOWN CURRENT
- 3.3V AND 5V FIXED OR ADJUSTABLE OUTPUT VOLTAGE (2V UP TO 5.2V)
- 120mΩ INTERNAL ACTIVE SWITCH
- LOW BATTERY VOLTAGE DETECTION
- REVERSE BATTERY PROTECTION

Applications

- ONE TO THREE CELLS BATTERY DEVICES
- PDA AND HAND HELD INSTRUMENTS
- CELLULAR PHONES - DIGITAL CORDLESS PHONE
- PAGERS
- GPS
- DIGITAL CAMERAS

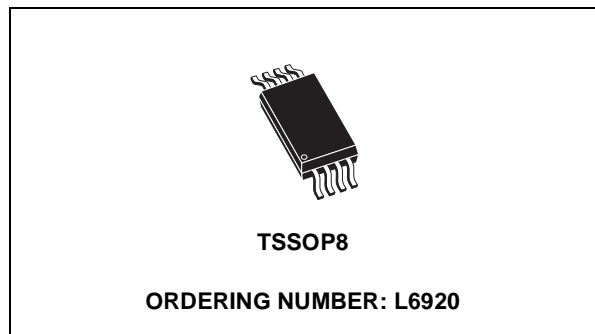

DESCRIPTION

The L6920 is a high efficiency step-up controller requiring only three external components to realize the conversion from the battery voltage to the selected output voltage.

The start up is guaranteed at 1V and the device is operating down to 0.6V.

Internal synchronous rectifier is implemented with a 120mΩ P-channel MOSFET and, in order to improve the efficiency, a variable frequency control is implemented.

APPLICATION CIRCUIT

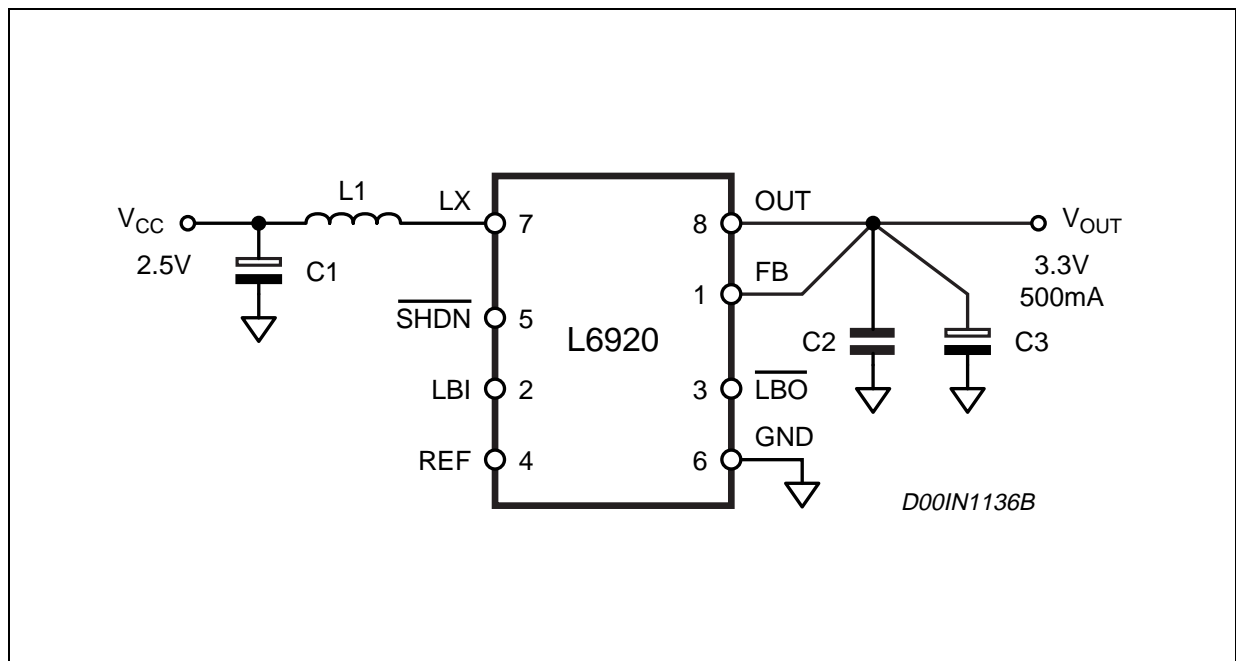

PIN DESCRIPTION

Pin	Name	Function
1	FB	Output voltage selector. Connect FB to GND for Vout=5V or to OUT for Vout=3.3V. Connect FB to an external resistor divider for adjustable output voltage (from 2V to 5.2V)
2	LBI	Battery low voltage detector input. The internal threshold is set to 1.23V
3	$\overline{\text{LBO}}$	Battery low voltage detector output. If the voltage at the LBI pin drops below the internal threshold typ. 1.23V, $\overline{\text{LBO}}$ goes low. The $\overline{\text{LBO}}$ is an open drain output and so a pull-up resistor (about 200K Ω) has to be added for correct output setting
4	REF	1.23V reference voltage. Bypass this output to GND with a 100nF capacitor for filtering high frequency noise. No capacitor is required for stability
5	$\overline{\text{SHDN}}$	Shutdown pin. When pin 5 is below 0.3V the device is in shutdown, when pin 5 is above 0.6V the device is operating.
6	GND	Ground pin
7	LX	Step-up inductor connection
8	OUT	Power OUTPUT pin

PIN CONNECTION (Top view)

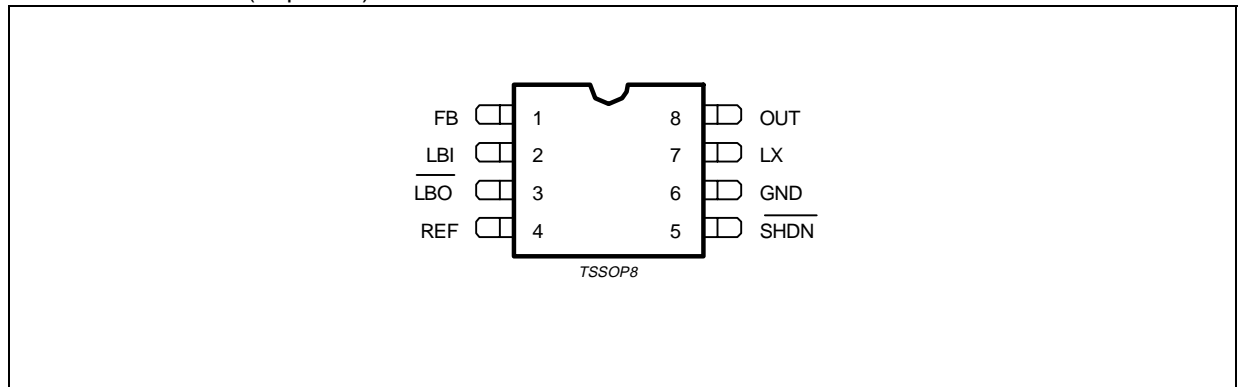

ABSOLUTE MAXIMUM RATINGS

Symbol	Parameter	Value	Unit
V _{ccmax}	V _{cc} to GND	6	V
	LBI, SHDN, FB to GND	6	V
V _{out max}	V _{out} to GND	6	V

THERMAL DATA

Symbol	Parameter	Value	Unit
R _{th j-amb}	Thermal Resistance Junction to Ambient	250	°C/W
T _j	Maximum Junction Temperature	150	°C

ELECTRICAL CHARACTERISTICS ($V_{in} = 2V$, $FB = GND$, $T_{amb} = -40^{\circ}C$ to $85^{\circ}C$)

Symbol	Parameter	Test Condition	Min.	Typ.	Max.	Unit
V_{CC} SECTION						
V_{in}	Minimum operating Input Voltage		0.6			V
V_{in}	Minimum Start Up Input Voltage				1	V
I_q	Quiescent Current	$FB = OUT, I_l = 0 \text{ mA}, V_{out} = 3.5V$		9	12	μA
		$FB = GND, I_l = 0 \text{ mA}, V_{out} = 5.2V$		11	15	μA
I_{sd}	Shut Down Current	$V_{in} = 5V, I_l = 0 \text{ mA}$		0.1	1	μA
I_{rev}	Reverse battery current	$V_{in} = -4V$		0.1	1	μA
POWER SECTION						
R_{on-N}	Active switch ON resistance			120	250	$m\Omega$
R_{on-P}	Synchronous switch ON resistance			120	250	$m\Omega$
CONTROL SECTION						
V_{out}	Output voltage	$FB = OUT, I_l = 0 \text{ mA}$	3.2	3.3	3.4	V
		$FB = GND, I_l = 0 \text{ mA}$	4.85	5	5.15	V
	Output voltage range	External divider	2		5.2	V
V_{LBI}	LBI threshold		1.18	1.23	1.27	V
V_{LBO}	\overline{LBO} logic LOW	$I_{sink} < 1 \text{ mA}$		0.2	0.4	V
I_{lim}	LX switch current limit		0.8	1	1.2	A
T_{onmax}	Maximum on time	$V_{out} = 2V \text{ to } 5.3V$	3.75	5	6.25	μs
T_{offmin}	Minimum off time	$V_{out} = 2V \text{ to } 5.3V$	0.75	1	1.25	μs
\overline{SHDN}	\overline{SHDN} logic LOW				0.3	V
	\overline{SHDN} logic HIGH		0.6			V
V_{ref}	Reference Voltage		1.18	1.23	1.27	V

Figure 1. Efficiency vs. Output Current

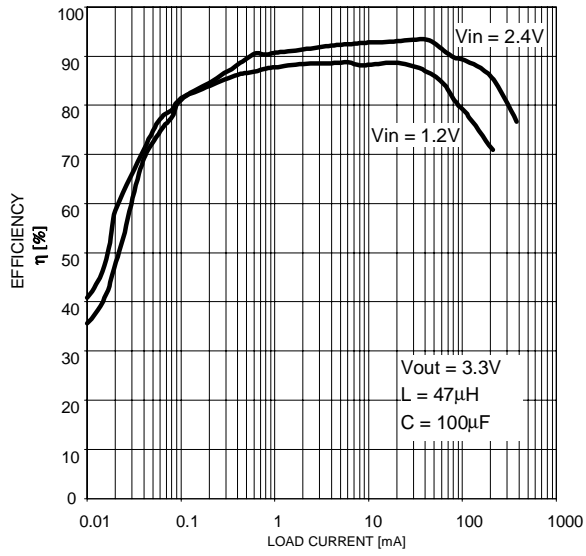

Figure 3. Startup Voltage vs Output Current

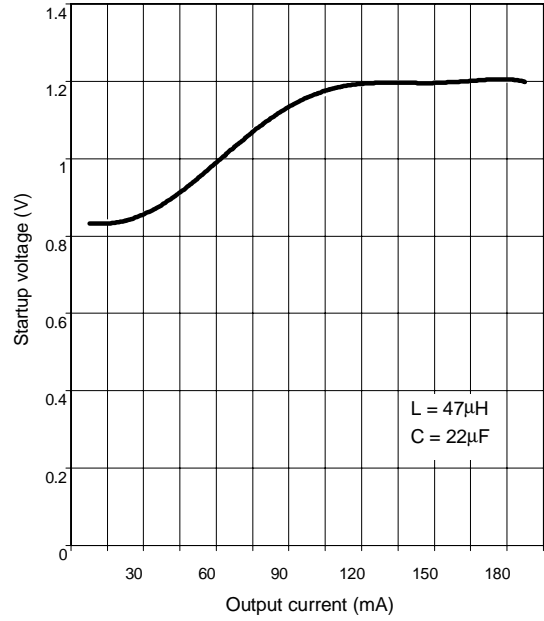
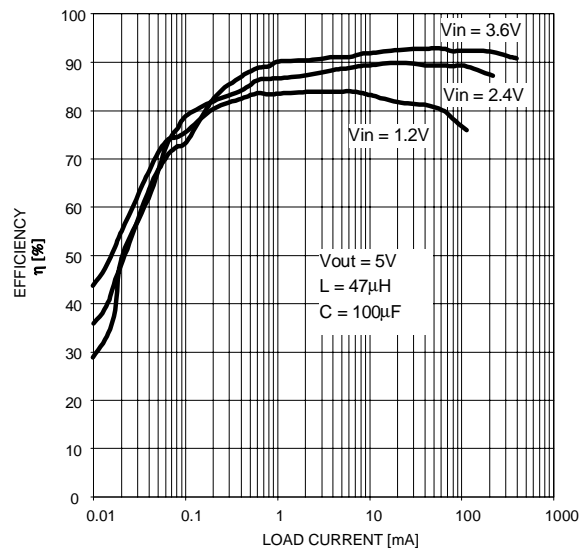

Figure 2. Efficiency vs. Output Current



DETAILED DESCRIPTION

The L6920 is a high efficiency, low voltage step-up DC/DC converter particularly suitable for 1 to 3 cells (Li-Ion/polymer, NiMH respectively) battery up conversion.

These performances are achieved via a strong reduction of quiescent current (10 μ A only) and adopting a synchronous rectification, that implies also a reduced cost in the application (no external diode required).

Operation is based on maximum ON time - minimum OFF time control, tailored by a current limit set to 1A. A simplified block diagram is shown here below.

Figure 4. Simplified Block Diagram

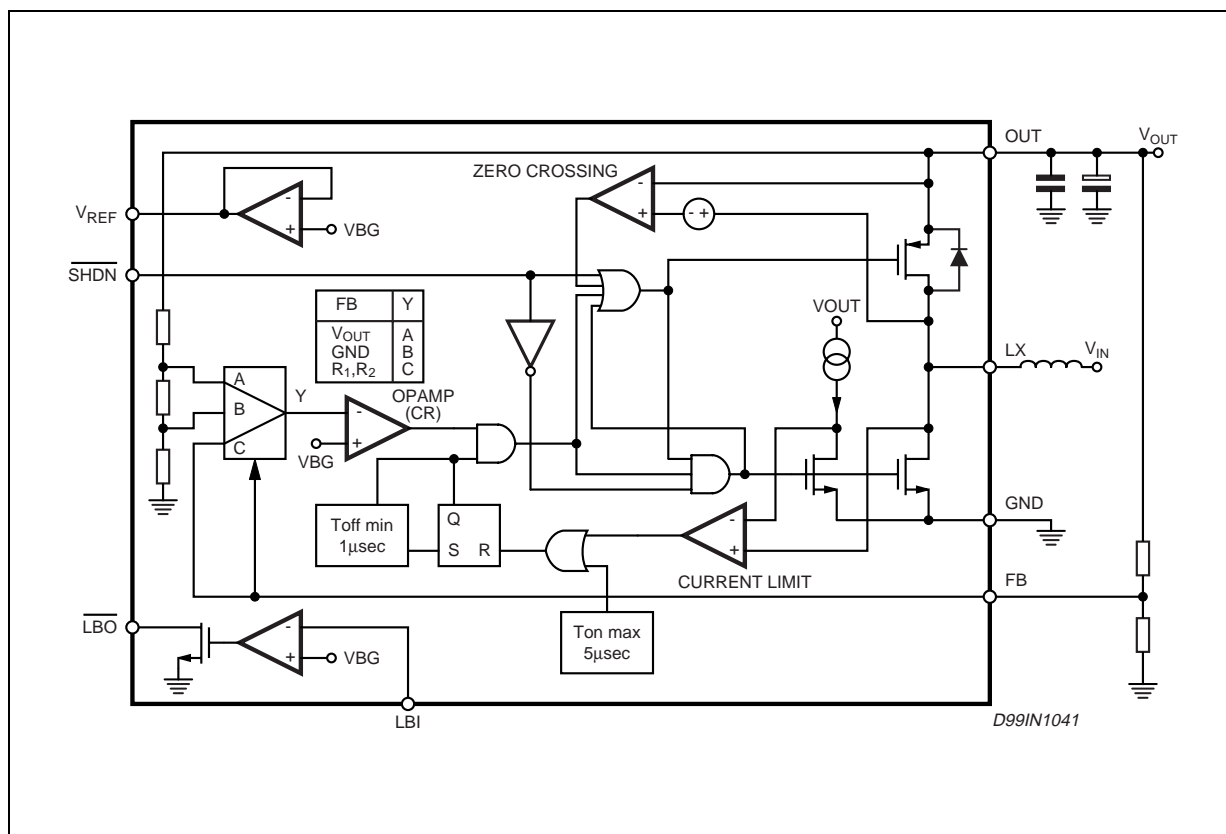

PRINCIPLE OF OPERATION

In L6920 the control is based on a comparator that continuously checks the status of output voltage.

If the output voltage is lower than the expected value the control makes the energy to be transferred to the load through the inductor, and this is accomplished repeating alternatively two basic steps:

- TON phase: the energy is transferred from the battery to the inductor by shorting LX node to ground via the N-channel power switch. The switch is turned off if the current flowing in the inductor reaches 1A or after a maximum on time set to 5 μ s.
- TOFF phase: the energy stored in the inductor is transferred to the load through the synchronous switch for at least a minimum off time equal to 1 μ s. After this, the synchronous switch is turned off as soon as the output voltage goes lower than the regulated voltage or the current flowing in the inductor goes down to zero.

So, in case of light load, the device works in PFM mode, as shown in figure 5.

Figure 5.1. 1 PFM mode Condition: $V_{out} = 5V$; $V_{in} = 1.5V$. Trace1: V_{out} (50mV~/div) Trace 4: I_L (100mA/div) Time div.: 5 μ s/div

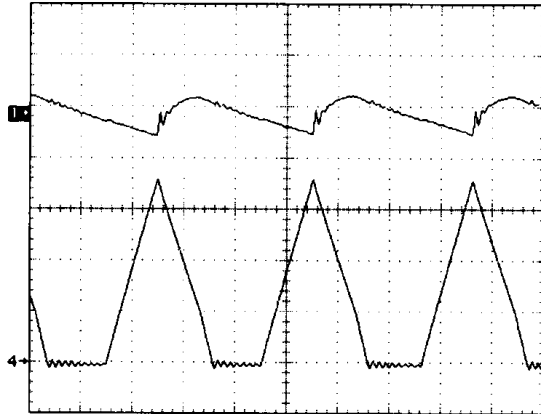
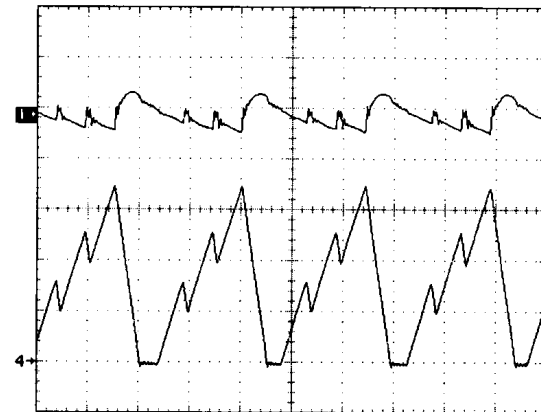

Figure 5.2. Heavier load - Train pulses overlapping. Trace1: V_{out} (100mV~/div) Trace 4: I_L (200mA/div) Time div.: 10 μ s/div



When Iload is heavier, then train pulses are overlapped. Figures 5.2 - 5.4 show some possible behaviors.

Figure 5.3. Heavy load - Inductor current ripples below I_{lim} Trace1: V_{out} (100mV~/div) Trace 4: I_L (200mA/div) Time div.: 20 μ s/div

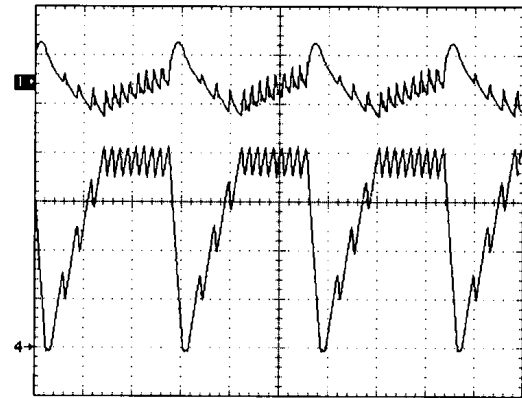
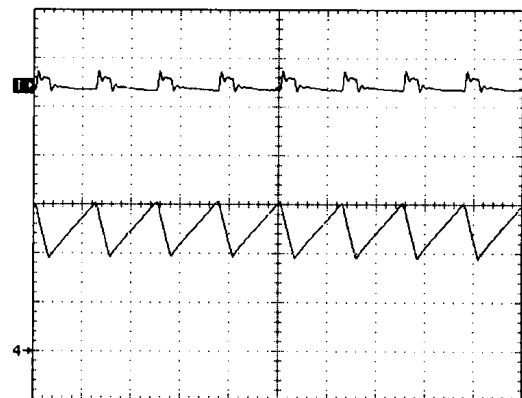

Figure 5.4. Heavy load and High ESR. Regulation falls in continuous mode of operation. Trace1: V_{out} (100mV~/div) Trace 4: I_L (200mA/div). Time div.: 5 μ s/div



Considering that current in the inductor is limited to 1A, the maximum load current is defined by the following relationship:

$$I_{load_lim} = \frac{V_{in}}{V_{out}} \cdot \left(I_{lim} - \frac{V_{out} - V_{in}}{2 \cdot L} \right) \cdot \eta \quad \text{eq. (1)}$$

Where η is the efficiency and $I_{lim} = 1A$.

Of course, if Iload is greater than Iload_lim the regulation is lost (figure 6).

Figure 6. No regulation. $I_{load} > I_{load_lim}$ Trace1:
 V_{out} (100mV~/div) Trace 4: I_L (200mA/div).
Time div.: 5 μ s/div

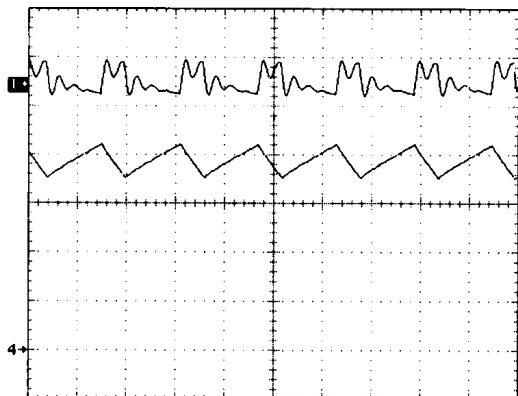

Start-up

One of the key features of L6920 is the startup at supply voltage down to 1V (please see the diagram in Figure 3. in case of heavy load).

The device leaves the startup mode of operation as soon as V_{OUT} goes over 1.4V. During startup, the synchronous switch is off and the energy is transferred to the load through its intrinsic body diode.

The N-channel switches with a very low R_{DSon} thanks to an internal charge pump used to bias the power mos gate. Because of this modified behavior, TON/TOFF times are lengthened. Current limit and zero crossing detection are still available.

Shutdown

In shutdown mode (\overline{SHDN} pulled low) all internal circuitries are turned off, minimizing the current provided by the battery ($I_{SHDN} < 100$ nA, in typical case). Both switches are turned off, and the low battery comparator output is forced in high impedance state.

The synchronous switch body diode causes a parasitic path between power supply and output that can't be avoided also in shutdown.

Low battery detection

The L6920 includes a low battery detector comparator. Threshold is V_{REF} voltage and a 1.3% hysteresis is added to avoid oscillations when input crosses the threshold slowly. The LBO is an open drain output so a pull up resistor is required for a proper use.

Reverse polarity

A protection circuit has been implemented to avoid that L6920 and the battery are destroyed in case of wrong battery insertion.

In addition, this circuit has been designed so that the current required by the battery is zero also in reverse polarity.

APPLICATION INFORMATION

Output voltage selection

Output voltage must be selected acting on FB pin. Three choices are available: fixed 3.3V, 5V or adjustable output set via an external resistor divider.

Table 1. Capacitors distributors main list

Manufacturer	Series	Cap Value (μF)	Rated Voltage (V)	ESR ($\text{m}\Omega$)
AVX	TPS	15 to 470	6.3	50 to 1500
KEMET	T510/T494/ T495	10 to 470	6	30 to 1000
PANASONIC	EEFCD	22 to 47	6.3	50 to 700
SANYO POSCAP	TPA/B/C	22 to 230	6.3	40 to 80
SPRAGUE	595D	100 to 390	6.3	160 to 700

Inductor selection

Usually, inductors ranging between $5\mu\text{H}$ to $40\mu\text{H}$ satisfy most of the applications.

Small value inductors have smaller physical size and guarantee a faster response to load transient but in steady state condition a bigger ripple on output voltage is generated. In fact the output ripple voltage is given by I_{peak} multiplied by ESR. Furthermore, as shown in equation (1), inductor size affects also the maximum current deliverable to the load. Lastly, a low series resistance is suggested if very high efficiency values are needed. Anyway, the saturation current of the choke should be higher than the peak current limit of the device (1A).

Good surface mounting inductors are available from COILCRAFTS, COILTRONICS, MURATA and other sources. In the following table are listed some suggested components.

Table 2. Inductors distributors main list

Manufacturer	Series	Inductor Value (μH)	Saturation Current (A)
Coilcraft	DO1813HC	22 to 33	1 to 1.2
	DO1608	4.7 to 15	0.9 to 1.5
Coiltronics	UP1B	22 to 33	1 to 1.2
	TP3	4.7 to 15	0.97 to 1.6
BI	HM76-2	22 to 33	1 to 1.2
	HM76-1	4.7 to 10	1 to 1.5
Murata	LQN6C	10 to 22	1.2 to 1.7
Panasonic	ELL6SH	10 to 22	0.9 to 1.5
	ELL6RH	5.1 to 10	1.1 to 1.55
Sumida	CR43	4.7 to 10	0.84 to 1.15

Layout Guidelines

The board layout is very important in order to minimize noise, high frequency resonance problems and electromagnetic interference.

It is essential to keep as small as possible the high switching current circulating paths to reduce radiation and resonance problems. So, the output and input cap should be very close to the device.

The external resistor dividers, if used, should be as close as possible to the pins of the device (FB and LBI) and as far as possible from the high current circulating paths, to avoid pick up noise.

Large traces for high current paths and an extended groundplane, help to reduce the noise and increase the efficiency.

For an example of recommended layout see the following evaluation board

DIM.	mm			inch		
	MIN.	TYP.	MAX.	MIN.	TYP.	MAX.
A			1.20			0.047
A1	0.050		0.150	0.002		0.006
A2	0.800	1.000	1.050	0.031	0.039	0.041
b	0.190		0.300	0.007		0.012
c	0.090		0.200	0.003		0.008
D (1)	2.900	3.000	3.100	0.114	0.118	0.122
E	6.200	6.400	6.650	0.244	0.252	0.260
E1 (1)	4.300	4.400	4.500	0.169	0.173	0.177
e		0.650			0.026	
L	0.450	0.600	0.750	0.018	0.024	0.027
L1		1.000			0.039	
k	0° (min.) 8° (max.)					
aaa			0.100			0.004

Note: 1. D and F does not include mold flash or protrusions. Mold flash or protrusions shall not exceed 0.15mm (.006inch) per side.

OUTLINE AND MECHANICAL DATA

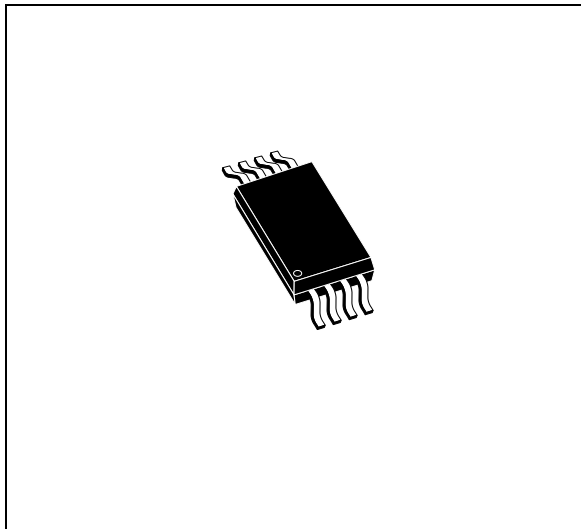

TSSOP8 (Body 4.4mm)

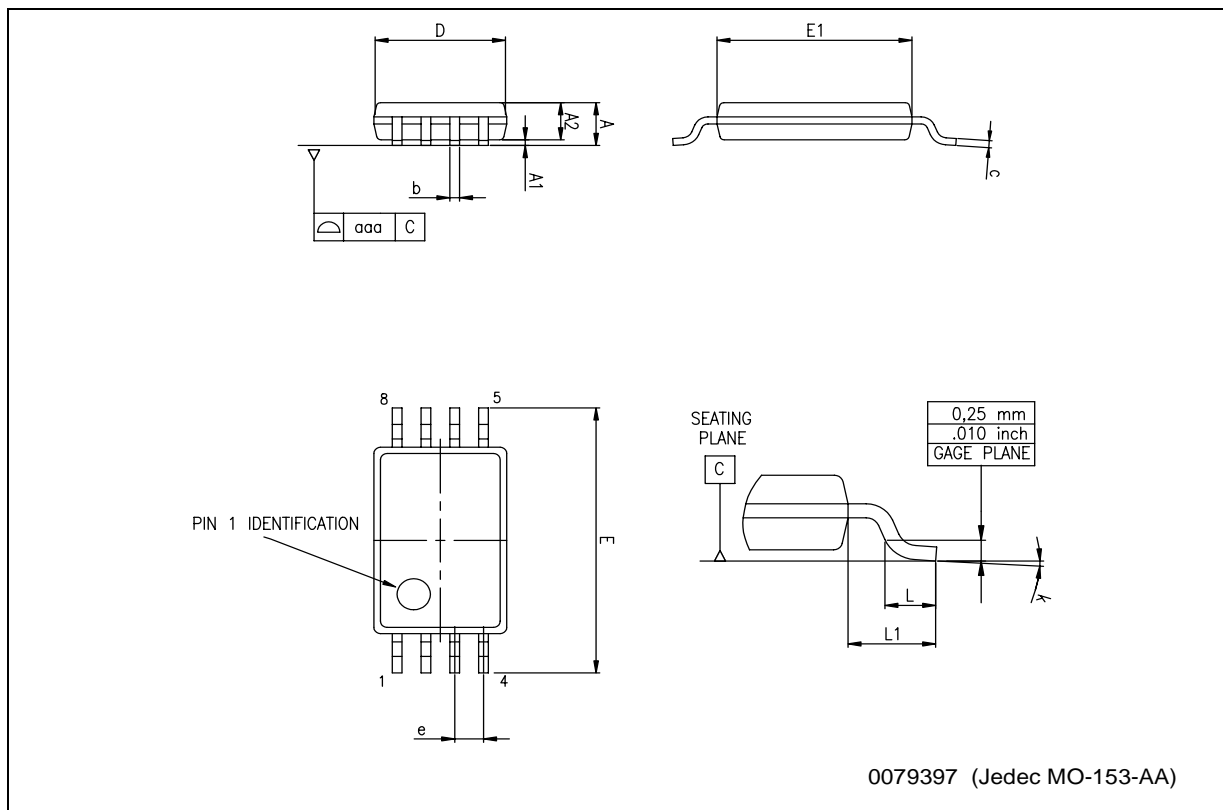

Information furnished is believed to be accurate and reliable. However, STMicroelectronics assumes no responsibility for the consequences of use of such information nor for any infringement of patents or other rights of third parties which may result from its use. No license is granted by implication or otherwise under any patent or patent rights of STMicroelectronics. Specifications mentioned in this publication are subject to change without notice. This publication supersedes and replaces all information previously supplied. STMicroelectronics products are not authorized for use as critical components in life support devices or systems without express written approval of STMicroelectronics.

The ST logo is a registered trademark of STMicroelectronics
© 2001 STMicroelectronics - All Rights Reserved

STMicroelectronics GROUP OF COMPANIES
Australia - Brazil - Canada - China - Finland - France - Germany - Hong Kong - India - Israel - Italy - Japan -Malaysia - Malta - Morocco -
Singapore - Spain - Sweden - Switzerland - United Kingdom - United States.
<http://www.st.com>