

# Complementary Silicon Plastic Power Transistors

... designed for use as high-frequency drivers in audio amplifiers.

- DC Current Gain Specified to 5.0 Amperes  
 $h_{FE} = 50$  (Min) @  $I_C = 0.5$  Adc  
 $= 10$  (Min) @  $I_C = 2.0$  Adc
- Collector-Emitter Sustaining Voltage —  
 $V_{CEO(sus)} = 250$  Vdc (Min) — MJE15032, MJE15033
- High Current Gain — Bandwidth Product  
 $f_T = 30$  MHz (Min) @  $I_C = 500$  mAdc
- TO-220AB Compact Package

## MAXIMUM RATINGS

Rating	Symbol	MJE15032 MJE15033	Unit
Collector-Emitter Voltage	$V_{CEO}$	250	Vdc
Collector-Base Voltage	$V_{CB}$	250	Vdc
Emitter-Base Voltage	$V_{EB}$	5.0	Vdc
Collector Current — Continuous — Peak	$I_C$	8.0 16	Adc
Base Current	$I_B$	2.0	Adc
Total Power Dissipation @ $T_C = 25^\circ\text{C}$ Derate above $25^\circ\text{C}$	$P_D$	50 0.40	Watts $\text{W}/^\circ\text{C}$
Total Power Dissipation @ $T_A = 25^\circ\text{C}$ Derate above $25^\circ\text{C}$	$P_D$	2.0 0.016	Watts $\text{W}/^\circ\text{C}$
Operating and Storage Junction Temperature Range	$T_J, T_{stg}$	-65 to +150	$^\circ\text{C}$

## THERMAL CHARACTERISTICS

Characteristic	Symbol	Max	Unit
Thermal Resistance, Junction to Case	$R_{\theta JC}$	2.5	$^\circ\text{C}/\text{W}$
Thermal Resistance, Junction to Ambient	$R_{\theta JA}$	62.5	$^\circ\text{C}/\text{W}$

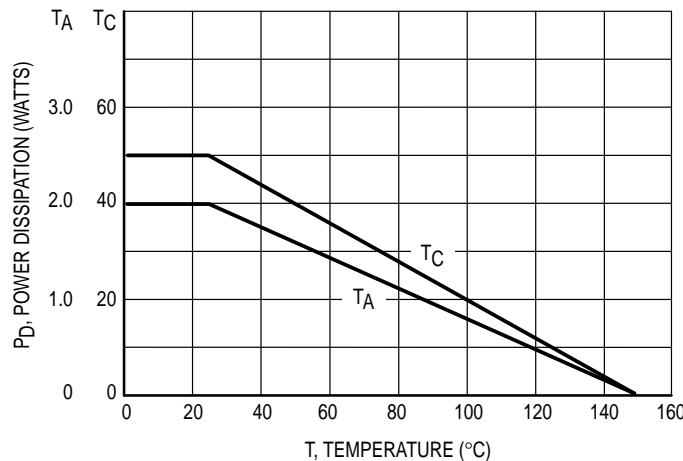


Figure 1. Power Derating

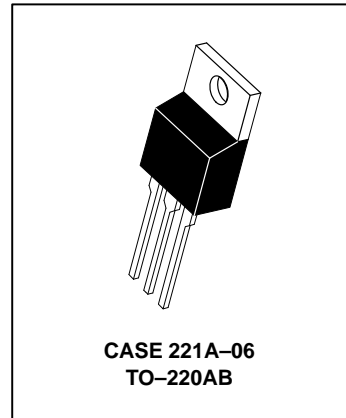
Preferred devices are Motorola recommended choices for future use and best overall value.

**NPN**  
**MJE15032\***

**PNP**  
**MJE15033\***

\*Motorola Preferred Device

**8.0 AMPERES**  
**POWER TRANSISTORS**  
**COMPLEMENTARY**  
**SILICON**  
**250 VOLTS**  
**50 WATTS**



# MJE15032 MJE15033

## ELECTRICAL CHARACTERISTICS (T<sub>C</sub> = 25°C unless otherwise noted)

Characteristic	Symbol	Min	Max	Unit
<b>OFF CHARACTERISTICS</b>				
Collector–Emitter Sustaining Voltage (1) (I <sub>C</sub> = 10 mAdc, I <sub>B</sub> = 0)	MJE15032, MJE15033 V <sub>CEO(sus)</sub>	250	—	Vdc
Collector Cutoff Current (V <sub>CB</sub> = 150 Vdc, I <sub>E</sub> = 0)	MJE15032, MJE15033 I <sub>CBO</sub>	—	10	μAdc
Emitter Cutoff Current (V <sub>BE</sub> = 5.0 Vdc, I <sub>C</sub> = 0)	I <sub>EBO</sub>	—	10	μAdc
<b>ON CHARACTERISTICS (1)</b>				
DC Current Gain (I <sub>C</sub> = 0.5 Adc, V <sub>CE</sub> = 5.0 Vdc) (I <sub>C</sub> = 1.0 Adc, V <sub>CE</sub> = 5.0 Vdc) (I <sub>C</sub> = 2.0 Adc, V <sub>CE</sub> = 5.0 Vdc)	h <sub>FE</sub>	50 50 10	— — —	—
Collector–Emitter Saturation Voltage (I <sub>C</sub> = 1.0 Adc, I <sub>B</sub> = 0.1 Adc)	V <sub>CE(sat)</sub>	—	0.5	Vdc
Base–Emitter On Voltage (I <sub>C</sub> = 1.0 Adc, V <sub>CE</sub> = 5.0 Vdc)	V <sub>BE(on)</sub>	—	1.0	Vdc
<b>DYNAMIC CHARACTERISTICS</b>				
Current Gain — Bandwidth Product (2) (I <sub>C</sub> = 500 mAdc, V <sub>CE</sub> = 10 Vdc, f <sub>test</sub> = 1.0 MHz)	f <sub>T</sub>	30	—	MHz

- (1) Pulse Test: Pulse Width ≤ 300 μs, Duty Cycle ≤ 2.0%.  
 (2) f<sub>T</sub> = |h<sub>fe</sub>| • f<sub>test</sub>.

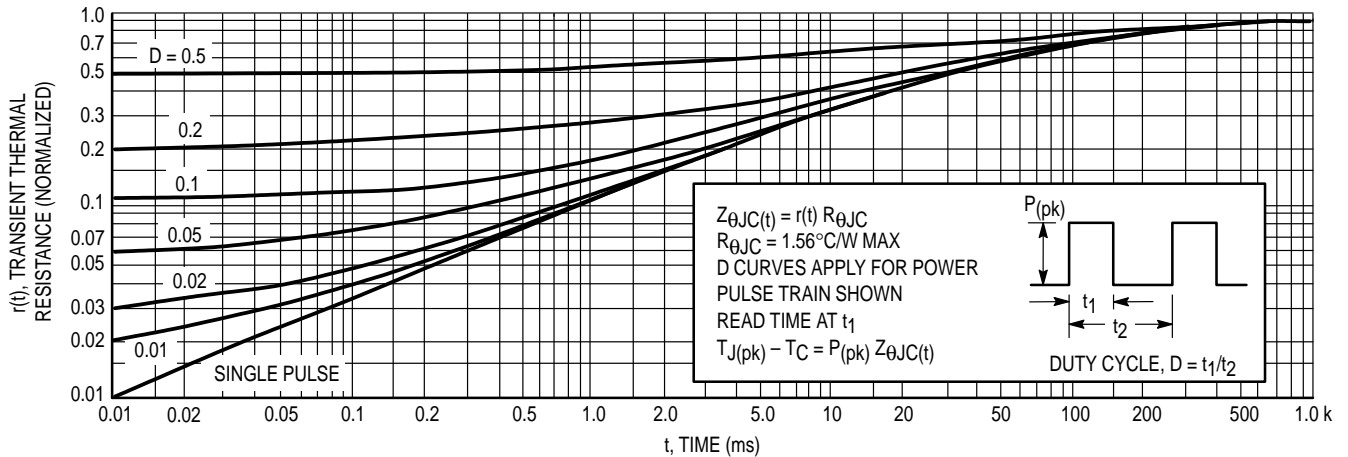
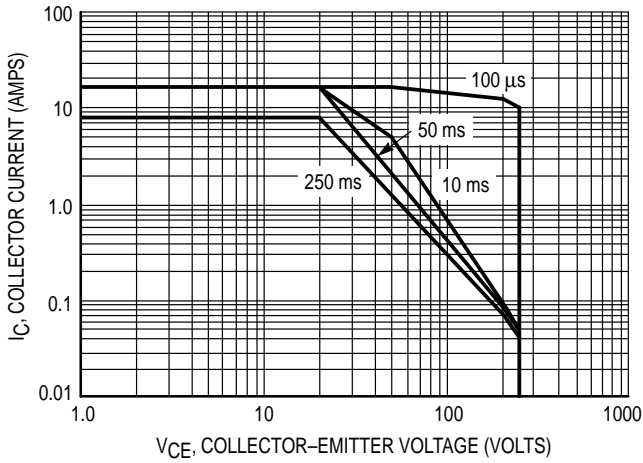


Figure 2. Thermal Response

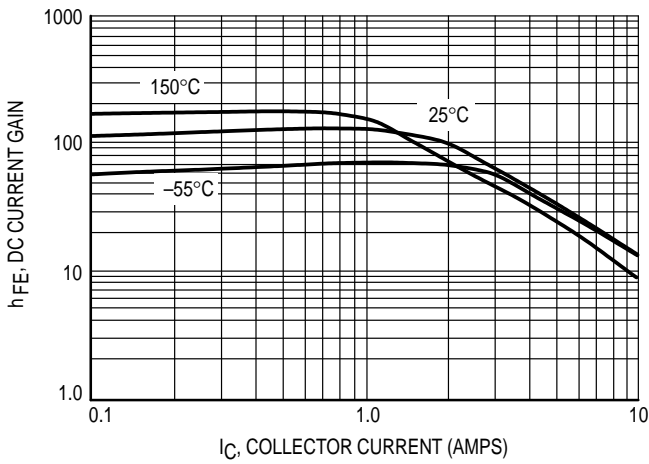


**Figure 3. MJE15032 & MJE15033  
Safe Operating Area**

There are two limitations on the power handling ability of a transistor: average junction temperature and second breakdown. Safe operating area curves indicate  $I_C - V_{CE}$  limits of the transistor that must be observed for reliable operation, i.e., the transistor must not be subjected to greater dissipation than the curves indicate.

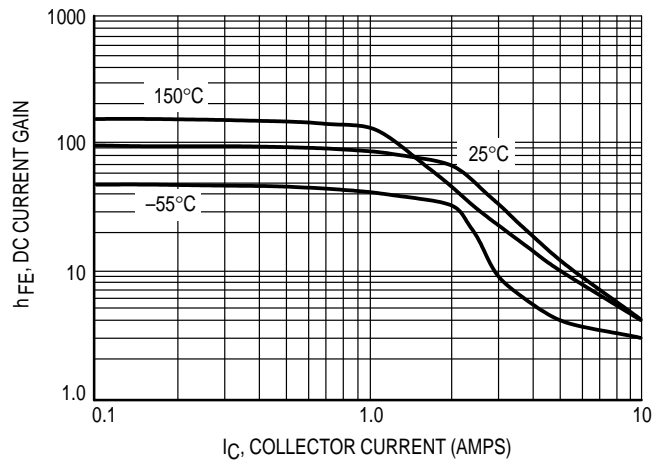
The data of Figures 3 and 4 is based on  $T_{J(pk)} = 150^\circ\text{C}$ ;  $T_C$  is variable depending on conditions. Second breakdown pulse limits are valid for duty cycles to 10% provided  $T_{J(pk)} < 150^\circ\text{C}$ .  $T_{J(pk)}$  may be calculated from the data in Figure 2. At high case temperatures, thermal limitations will reduce the power that can be handled to values less than the limitations imposed by second breakdown.

**NPN — MJE15032**

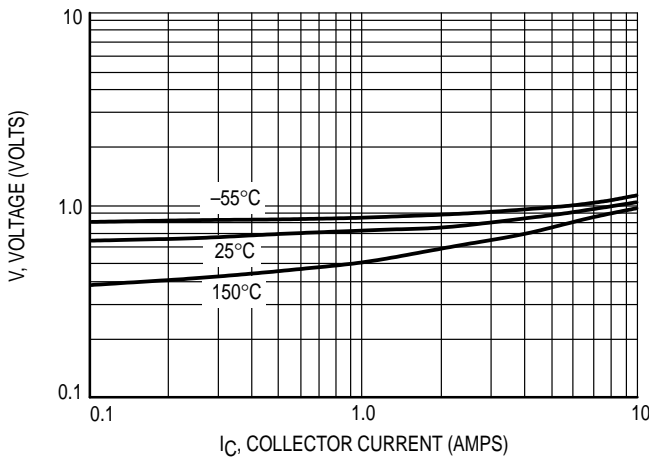


**Figure 4. NPN — MJE15032  
 $V_{CE} = 5\text{ V}$  DC Current Gain**

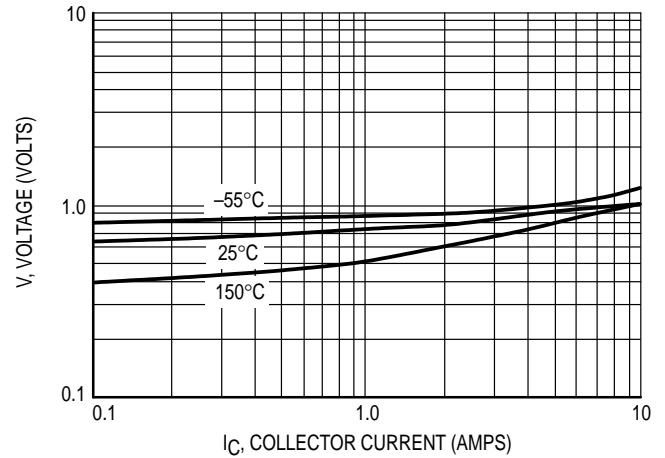
**PNP — MJE15033**



**Figure 5. PNP — MJE15033  
 $V_{CE} = 5\text{ V}$  DC Current Gain**



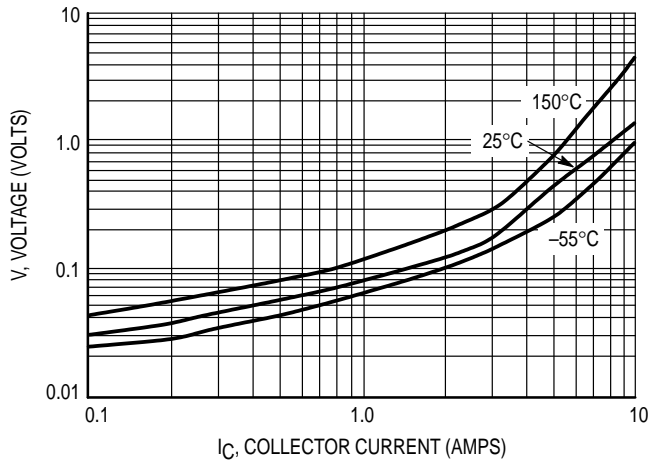
**Figure 6. NPN — MJE15032  
 $V_{CE} = 5\text{ V}$   $V_{BE(on)}$  Curve**



**Figure 7. PNP — MJE15033  
 $V_{CE} = 5\text{ V}$   $V_{BE(on)}$  Curve**

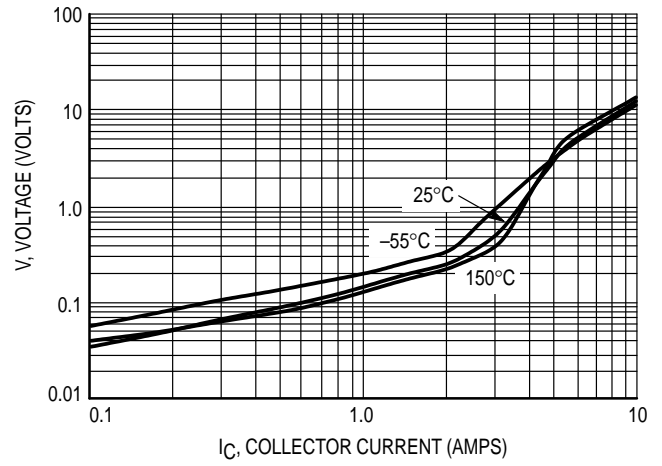
**MJE15032 MJE15033**

**NPN — MJE15032**

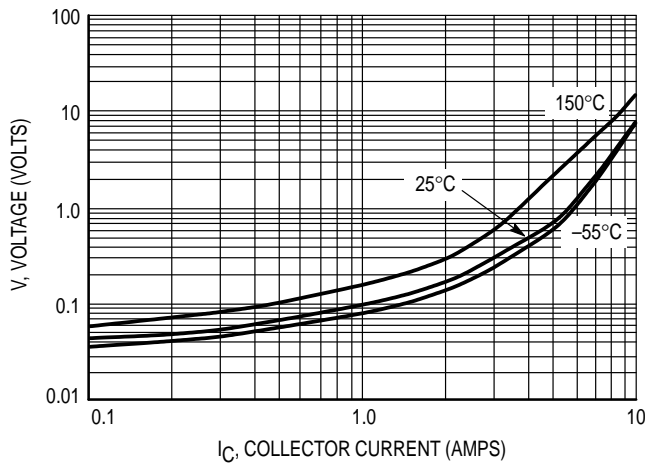


**Figure 8. NPN — MJE15032**  
 **$V_{CE(sat)}$   $I_C/I_B = 10$**

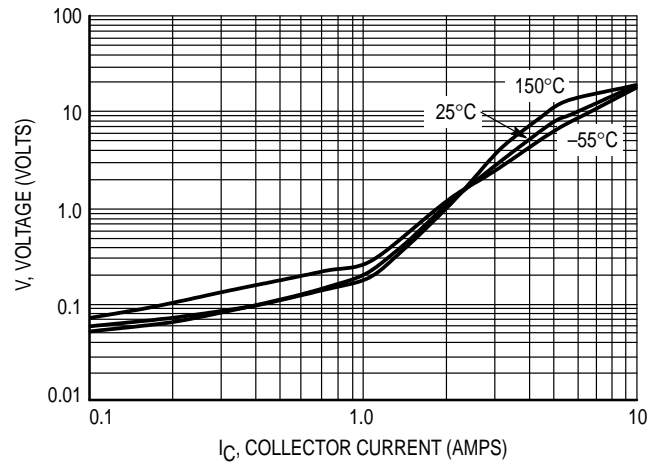
**PNP — MJE15033**



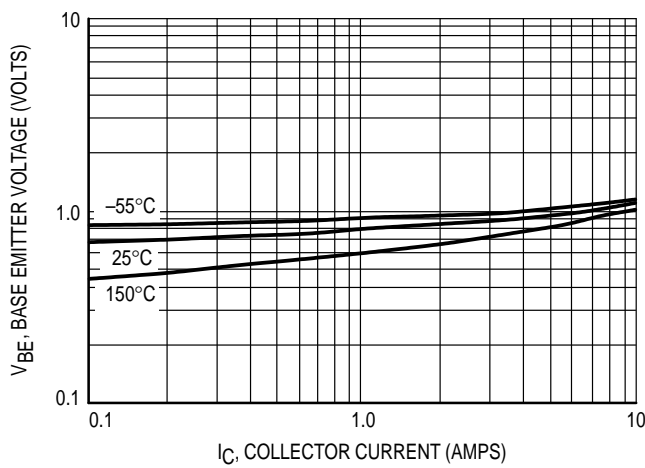
**Figure 9. PNP — MJE15033**  
 **$V_{CE(sat)}$   $I_C/I_B = 10$**



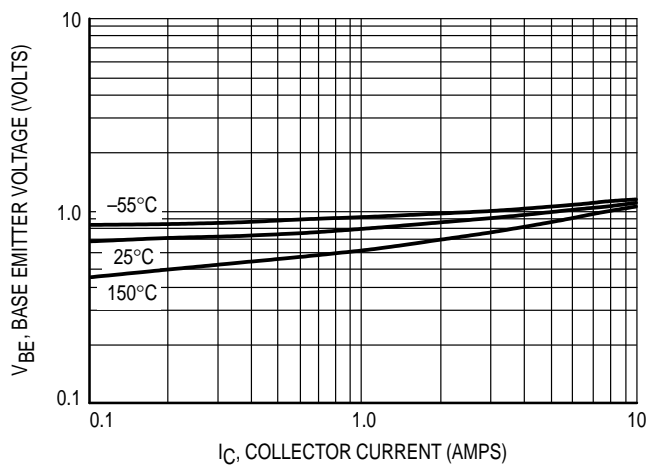
**Figure 10. NPN — MJE15032**  
 **$V_{CE(sat)}$   $I_C/I_B = 20$**



**Figure 11. PNP — MJE15033**  
 **$V_{CE(sat)}$   $I_C/I_B = 20$**

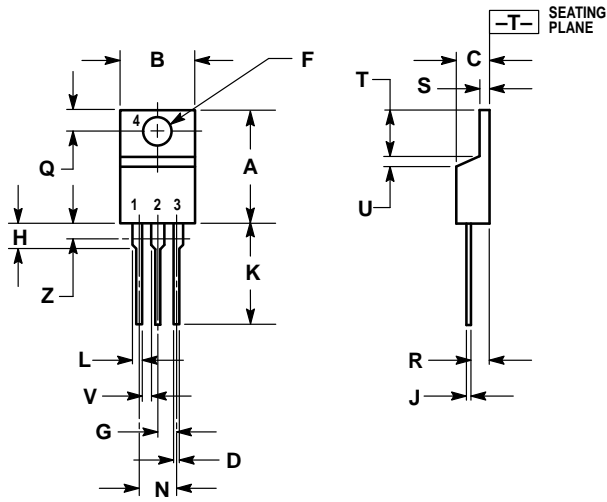


**Figure 12. NPN — MJE15032**  
 **$V_{BE(sat)}$   $I_C/I_B = 10$**



**Figure 13. PNP — MJE15033**  
 **$V_{BE(sat)}$   $I_C/I_B = 10$**

PACKAGE DIMENSIONS




- NOTES:
1. DIMENSIONING AND TOLERANCING PER ANSI Y14.5M, 1982.
  2. CONTROLLING DIMENSION: INCH.
  3. DIMENSION Z DEFINES A ZONE WHERE ALL BODY AND LEAD IRREGULARITIES ARE ALLOWED.

DIM	INCHES		MILLIMETERS	
	MIN	MAX	MIN	MAX
A	0.570	0.620	14.48	15.75
B	0.380	0.405	9.66	10.28
C	0.160	0.190	4.07	4.82
D	0.025	0.035	0.64	0.88
F	0.142	0.147	3.61	3.73
G	0.095	0.105	2.42	2.66
H	0.110	0.155	2.80	3.93
J	0.018	0.025	0.46	0.64
K	0.500	0.562	12.70	14.27
L	0.045	0.060	1.15	1.52
N	0.190	0.210	4.83	5.33
Q	0.100	0.120	2.54	3.04
R	0.080	0.110	2.04	2.79
S	0.045	0.055	1.15	1.39
T	0.235	0.255	5.97	6.47
U	0.000	0.050	0.00	1.27
V	0.045	—	1.15	—
Z	—	0.080	—	2.04

- STYLE 1:
- PIN 1. BASE
  - COLLECTOR
  - EMITTER
  - COLLECTOR

CASE 221A-06  
TO-220AB  
ISSUE Y

Motorola reserves the right to make changes without further notice to any products herein. Motorola makes no warranty, representation or guarantee regarding the suitability of its products for any particular purpose, nor does Motorola assume any liability arising out of the application or use of any product or circuit, and specifically disclaims any and all liability, including without limitation consequential or incidental damages. "Typical" parameters which may be provided in Motorola data sheets and/or specifications can and do vary in different applications and actual performance may vary over time. All operating parameters, including "Typicals" must be validated for each customer application by customer's technical experts. Motorola does not convey any license under its patent rights nor the rights of others. Motorola products are not designed, intended, or authorized for use as components in systems intended for surgical implant into the body, or other applications intended to support or sustain life, or for any other application in which the failure of the Motorola product could create a situation where personal injury or death may occur. Should Buyer purchase or use Motorola products for any such unintended or unauthorized application, Buyer shall indemnify and hold Motorola and its officers, employees, subsidiaries, affiliates, and distributors harmless against all claims, costs, damages, and expenses, and reasonable attorney fees arising out of, directly or indirectly, any claim of personal injury or death associated with such unintended or unauthorized use, even if such claim alleges that Motorola was negligent regarding the design or manufacture of the part. Motorola and  are registered trademarks of Motorola, Inc. Motorola, Inc. is an Equal Opportunity/Affirmative Action Employer.

Mfax is a trademark of Motorola, Inc.

**How to reach us:**

**USA/EUROPE/Locations Not Listed:** Motorola Literature Distribution;  
P.O. Box 5405, Denver, Colorado 80217. 303-675-2140 or 1-800-441-2447

**JAPAN:** Nippon Motorola Ltd.; Tatsumi-SPD-JLDC, 6F Seibu-Butsuryu-Center,  
3-14-2 Tatsumi Koto-Ku, Tokyo 135, Japan. 81-3-3521-8315

**Mfax™:** RMFAX0@email.sps.mot.com – TOUCHTONE 602-244-6609  
**INTERNET:** <http://Design-NET.com>

**ASIA/PACIFIC:** Motorola Semiconductors H.K. Ltd.; 8B Tai Ping Industrial Park,  
51 Ting Kok Road, Tai Po, N.T., Hong Kong. 852-26629298

