

M54133FP/GP

EARTH LEAKAGE CURRENT DETECTOR

DESCRIPTION

The M54133 is a semiconductor integrated circuit designed for high-speed type earth leakage breakers. This IC has built-in anti-lightning-surge function and anti-inverter-noise function.

FEATURES

- Improvement of ability against unwanted tripping by lightning -surge.
 - Adopt the two times counting system.
 - Improvement of ability against needless action for lightning-impulse.
- Improvement of ability against unwanted tripping by inverter -noise.
 - Built-in operational amplifier (of low current dissipation) for active low-pass filter.
 - Improvement of ability against needless action for high frequency and high harmonics.
- Built-in delay time function
 - An external capacitor is used to set the delay time.
- High input sensitivity : $V_T=11.5mV_{rms}$ Typ.
- Low-current dissipation (at $R_{REF}=180k\Omega$)
 - In stand-by condition : $I_s=610\mu A$ Typ.
- High stabilities design
 - Adopt the circuits that is not affected by fluctuations of supply voltage/ambient temperature.

PIN CONFIGURATION (TOP VIEW)

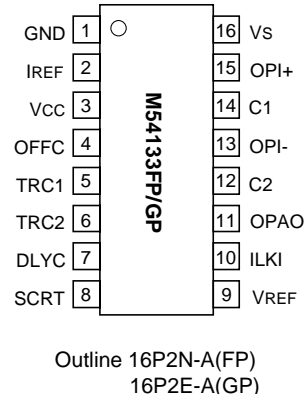

APPLICATION

Earth leakage breaker

RECOMMENDED OPERATING CONDITIONS

Supply voltage range.....7 to 12V

Operating ambient temperature.....-20 to +85°C

BLOCK DIAGRAM

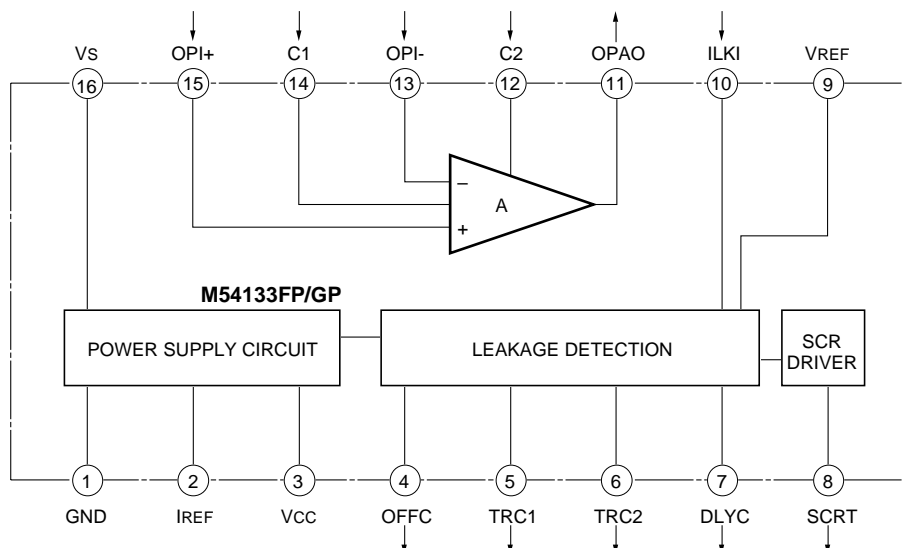

M54133FP/GP**EARTH LEAKAGE CURRENT DETECTOR****ABSOLUTE MAXIMUM RATINGS** (Ta=25°C, unless otherwise noted)

Symbol	Parameter	Conditions	Ratings	Unit
IS	Supply current		4	mA
VSMAX	Maximum supply voltage		15	V
Vid	Differential input voltage	OPI+ to OPI-	-0.8 to +0.8	V
IIOp	Differential input current	OPI+ to OPI-	-5 to +5	mA
IIG	Input current	VREF to GND	10	mA
Pd	Power dissipation		200	mW
Topr	Operating ambient temperature		-20 to +85	°C
Tstg	Storage temperature		-55 to +125	°C

ELECTRICAL CHARACTERISTICS (Ta=25°C, unless otherwise noted)

Symbol	Parameter		Vs	Test conditions	Limits			Unit	
					Min.	Typ.	Max.		
Is0	Power supply circuit	Supply current (in standby)	9V		520	610	700	μA	
Is1		Supply current (while detecting leakage)			560	650	740	μA	
Is2		Supply current (immediately after drive a SCR)			480	570	660	μA	
–		Ambient temperature dependence of Is0			9V	Ta=-25 to +85°C	–	-0.2	–
VSMAX	Power supply circuit	Maximum supply voltage		Is=4mA	–	13.9	15	V	
VCC		VCC-pin output voltage	9V	IoH=-1mA	–	5.2	–	V	
GV		Voltage gain		f=1kHz	–	40	–	dB	
BW	Operational amplifier	Frequency band width		-3dB	–	6	–	kHz	
VO		Maximum output voltage			–	3.5	–	VPP	
IOH		OPOA-pin "H" output current	9V		–	2.8	–	mA	
IOL		OPOA-pin "L" output current		–	0.8	–	mA		
VOoff		Output offset voltage		–	0	–	mV		
IIC		Input bias current		–	125	–	nA		
VIC		Differential input clamp voltage			Iidc=±4mA	–	±0.8	–	V
Vion		DC input voltage of leakage detection			With respect to VREF	–	±14.0	–	mVdc
IiH	ILKI-pin input bias current	9V		VIN=VREF	–	220	–	nA	
Vo	VREF-pin output voltage			IoH=-200μA	–	2.4	–	V	
VRCL	VREF-GND clamp voltage		IRCL=5mA	–	4.7	–	V		
Eloh1	3-ms circuit	Accuracy of TRC1-pin "H" output current		Vo=0V ; IoH1=-7.6μA	-20	–	+20	%	
VTH1		TRC1 threshold voltage	9V		–	2.4	–	V	
ETw1		Accuracy of Tw1 pulse width		C=0.01μF ; Tw1=3ms	-15	–	+15	%	
–		Ambient temperature dependence of Tw1		Ta=-20 to +85°C	–	0	–	%/°C	
Eloh2	1-ms circuit	Accuracy of TRC2-pin "H" output current		Vo=0V ; IoH2=-7.6μA	-20	–	+20	%	
VTH2		TRC2 threshold voltage	9V		–	2.4	–	V	
ETw2		Accuracy of Tw2 pulse width		C=0.0047μF ; Tw2=1.5ms	-15	–	+15	%	
–		Ambient temperature dependence of Tw2		Ta=-20 to +85°C	–	0	–	%/°C	
VT		Total AC input voltage of leakage detection		60Hz	–	11.5	–	mVrms	
–		Ambient temperature dependence of VT	9V	Ta=+25°C→+85°C	–	-8.0	–	%	
				Ta=+25°C→-20°C	–	+2.0	–	%	
EloH	Reset circuit	Accuracy of OFFC-pin "H" output current		Vo=0V ; IoH=-7.6μA	-20	–	+20	%	
VTH		OFFC threshold voltage	9V		–	2.4	–	V	
ETw3		Accuracy of reset time pulse width	9V	C=0.33μF ; Tw3=75ms	-30	–	+30	%	
EloH	Delay circuit	Accuracy of DLYC-pin "H" output current		Vo=0V ; IoH=-7.6μA	-20	–	+20	%	
VTH		DLYC threshold voltage	9V		–	2.4	–	V	
ETw4		Accuracy of delay timer pulse width	9V	C=1.0μF ; Tw4=300ms	-30	–	+30	%	
Vol8	SCR driver circuit	SCRT-pin "L" output voltage	9V	IoL=200μA	–	0.1	0.2	V	
IoHC		SCRT-pin "H" output current	9V	Vo=8V	Ta=-20°C	-100	-160	–	μA
IoHn					Ta=+20°C	-50	-130	–	μA
IoHh					Ta=+85°C	-33	-100	–	μA
Vsoff	Supply voltage for IoH hold		–		–	3.0	4.0	V	

M54133FP/GP

EARTH LEAKAGE CURRENT DETECTOR

WITHOUT DELAY FUNCTION

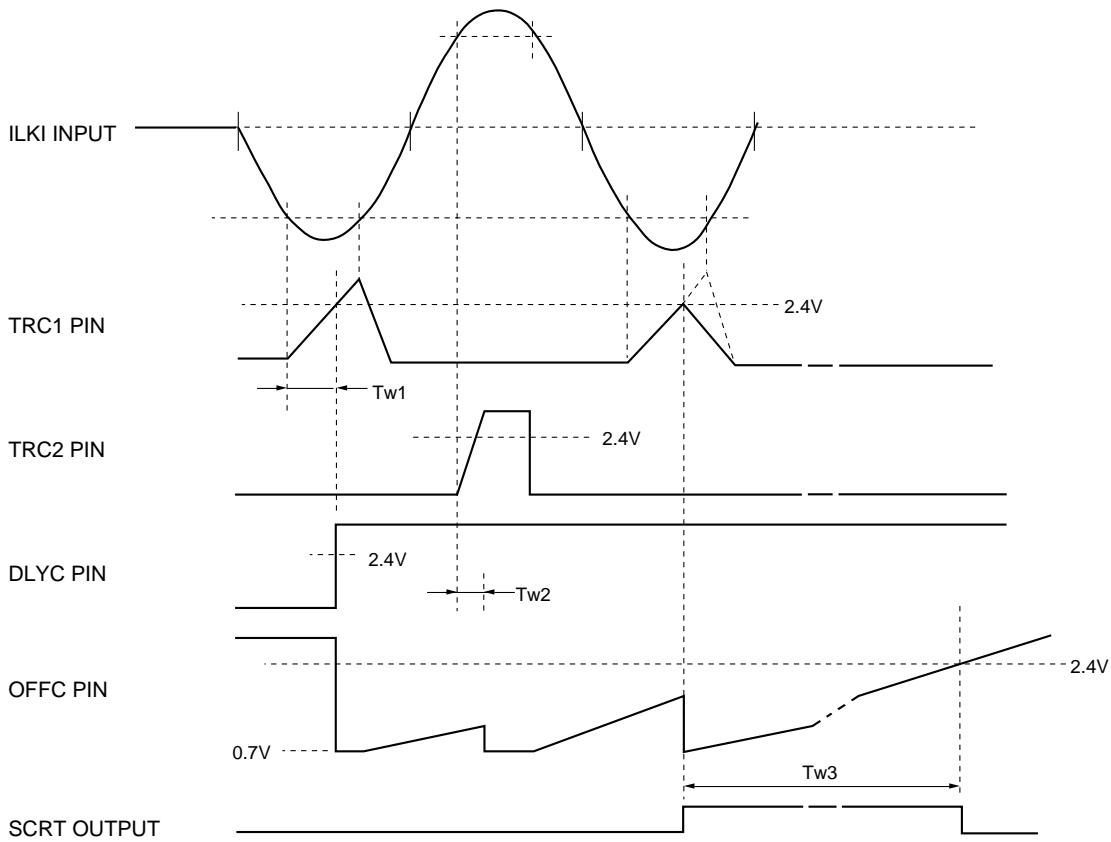

USING DELAY FUNCTION

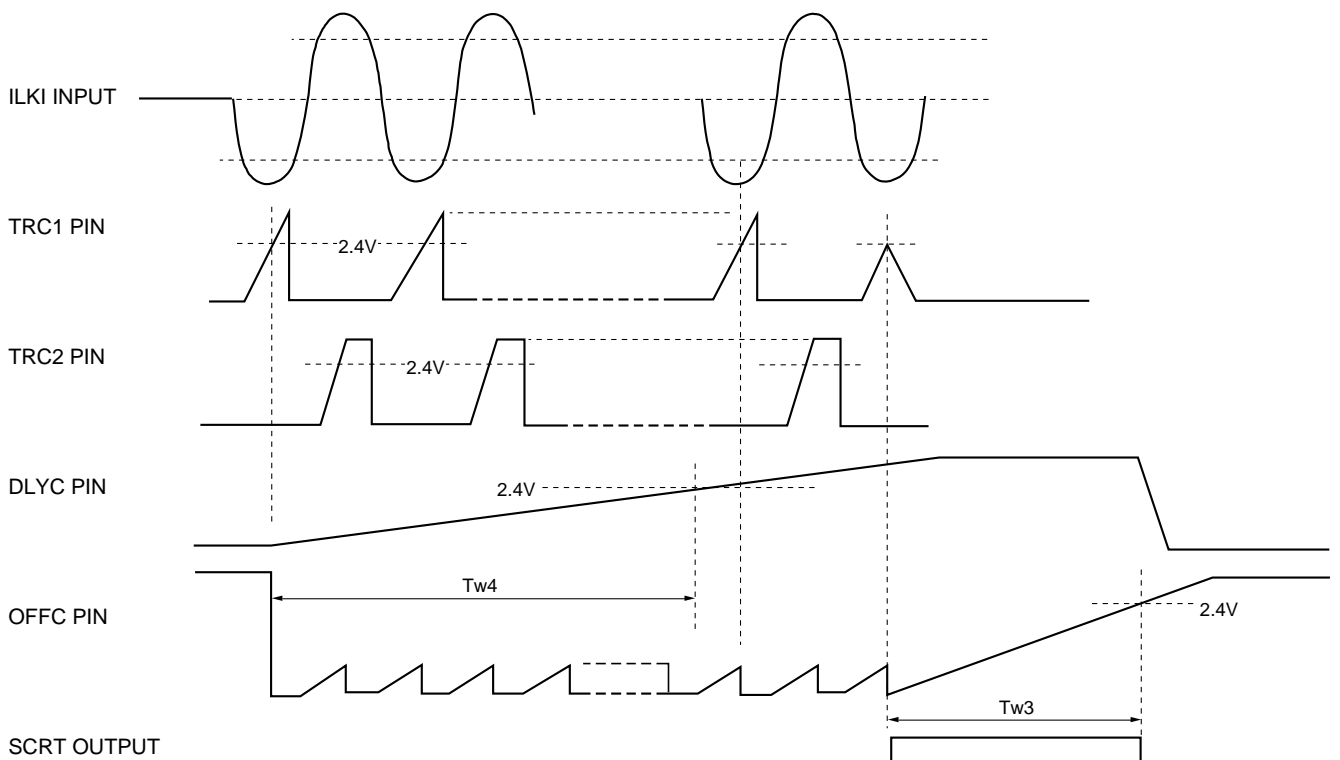

M54133FP/GP

EARTH LEAKAGE CURRENT DETECTOR

TYPICAL CHARACTERISTICS

**THERMAL DERATING
(MAXIMUM RATING)**

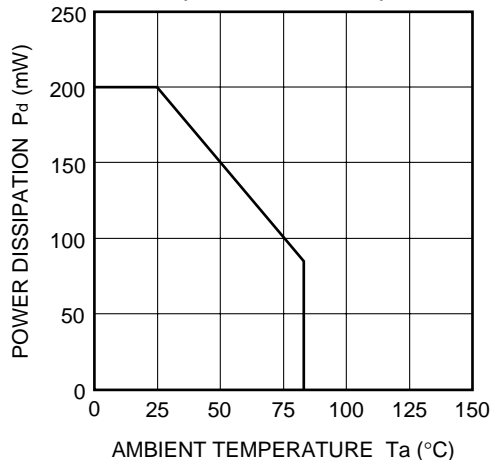

**SUPPLY CURRENT VS. SUPPLY VOLTAGE
CHARACTERISTICS**

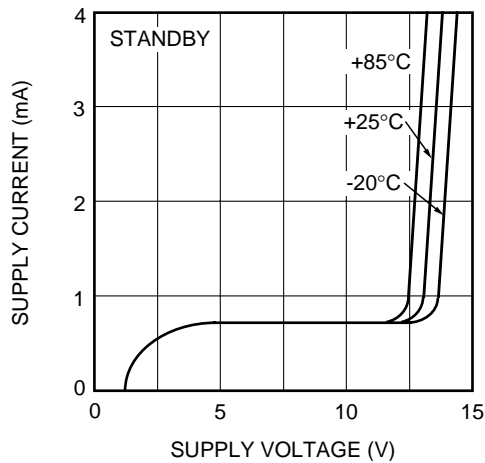

**SUPPLY CURRENT VS. SUPPLY VOLTAGE
CHARACTERISTICS**

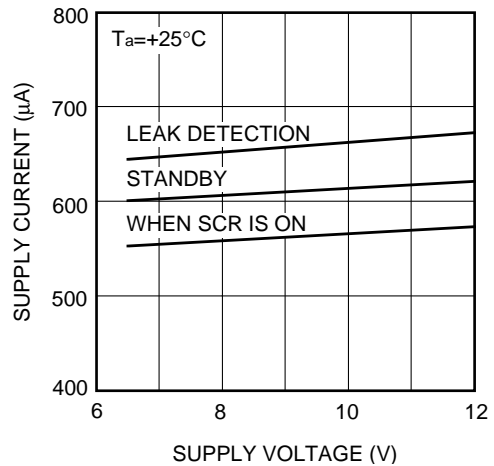

**SUPPLY CURRENT VS. AMBIENT TEMPERATURE
CHARACTERISTICS**

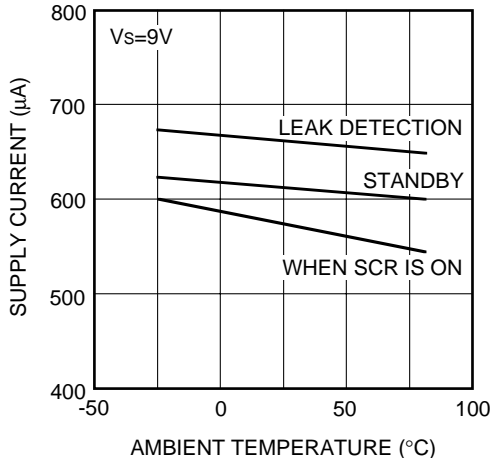

**VOLTAGE GAIN VS. FREQUENCY
CHARACTERISTICS**

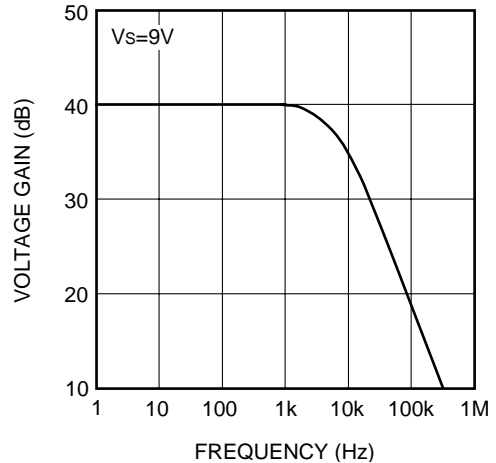

M54133FP/GP

EARTH LEAKAGE CURRENT DETECTOR

**OPERATIONAL AMPLIFIER
INPUT CURRENT BIAS VS.
AMBIENT TEMPERATURE CHARACTERISTICS**

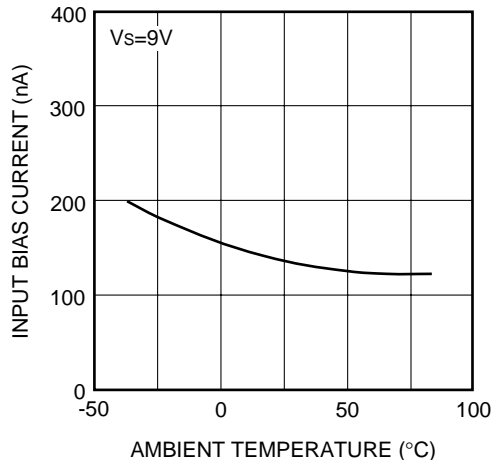

**MAXIMUM OPERATIONAL AMPLIFIER
OUTPUT CURRENT VS.
AMBIENT TEMPERATURE CHARACTERISTICS**

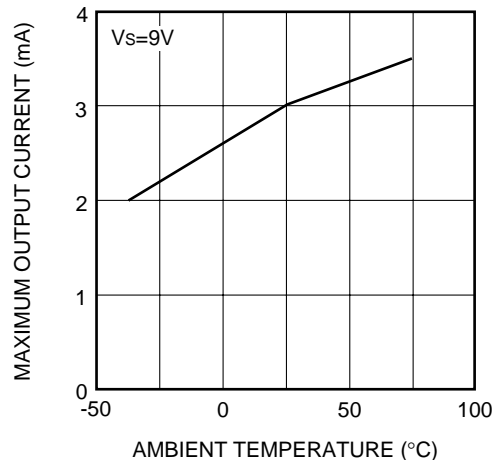

**I_{REF} OUTPUT VOLTAGE VS.
SUPPLY VOLTAGE CHARACTERISTICS**

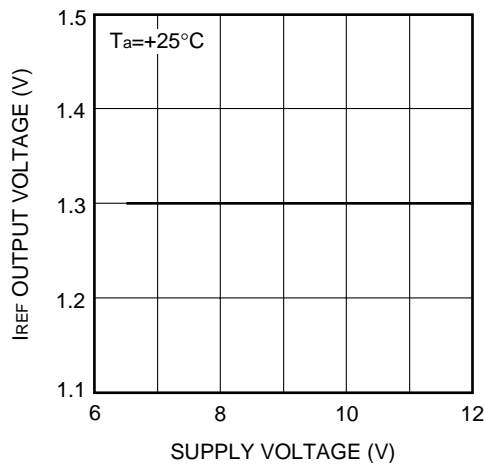

**I_{REF} OUTPUT VOLTAGE VS.
AMBIENT TEMPERATURE CHARACTERISTICS**

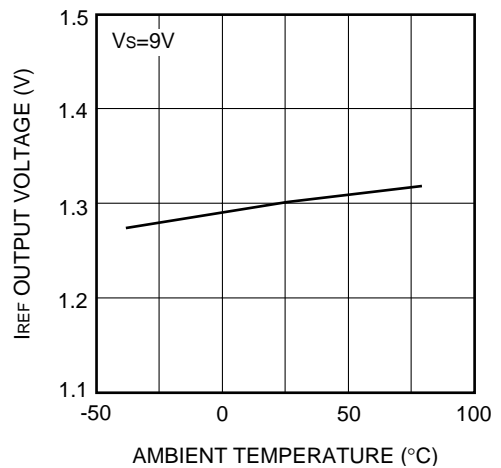

**V_{REF} OUTPUT VOLTAGE VS.
SUPPLY VOLTAGE CHARACTERISTICS**

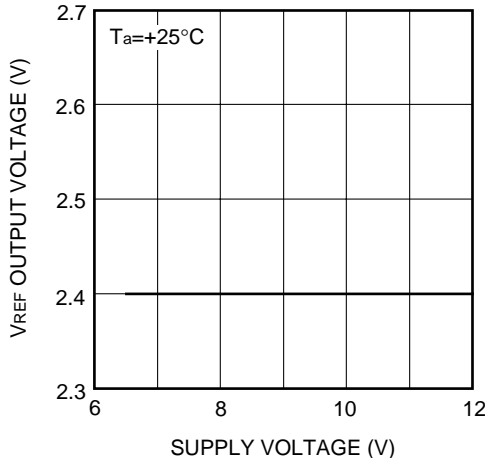

**V_{REF} OUTPUT VOLTAGE VS.
AMBIENT TEMPERATURE CHARACTERISTICS**

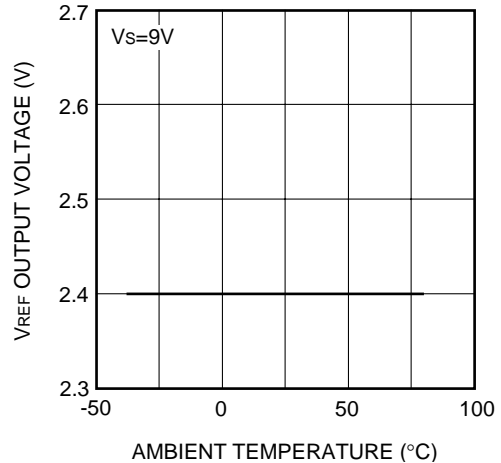

M54133FP/GP

EARTH LEAKAGE CURRENT DETECTOR

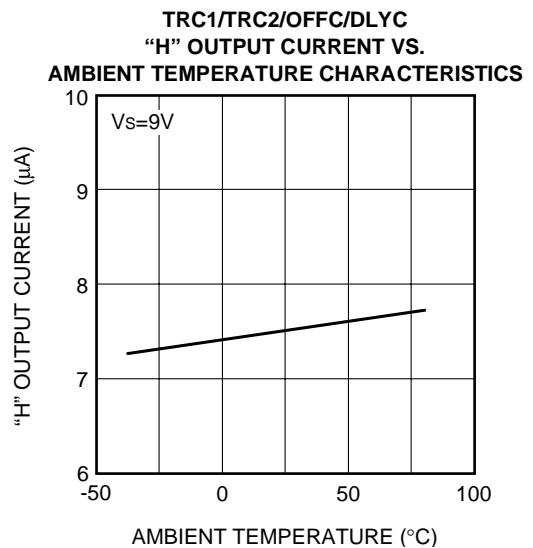
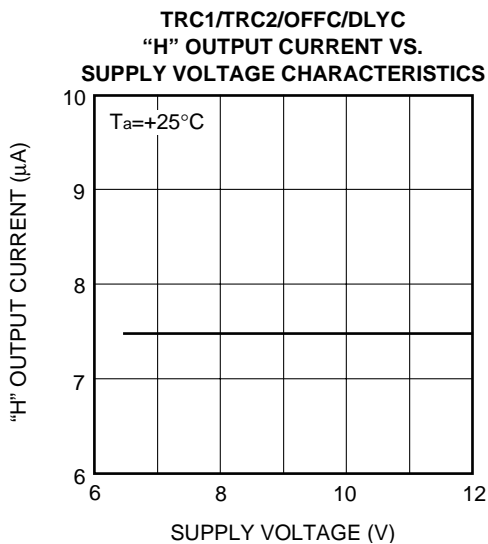
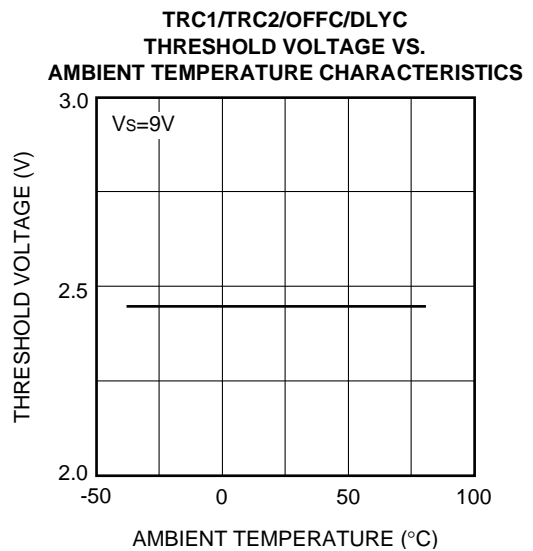
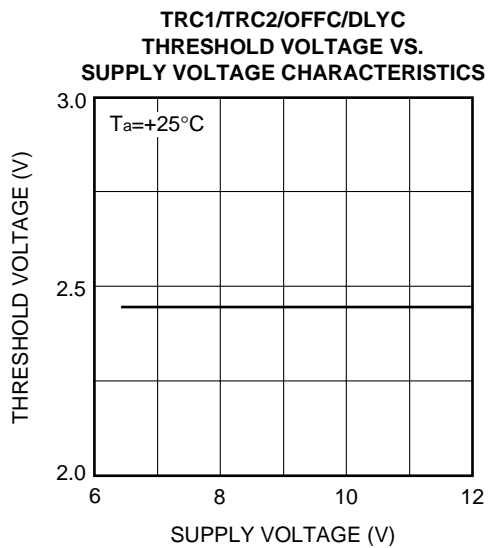
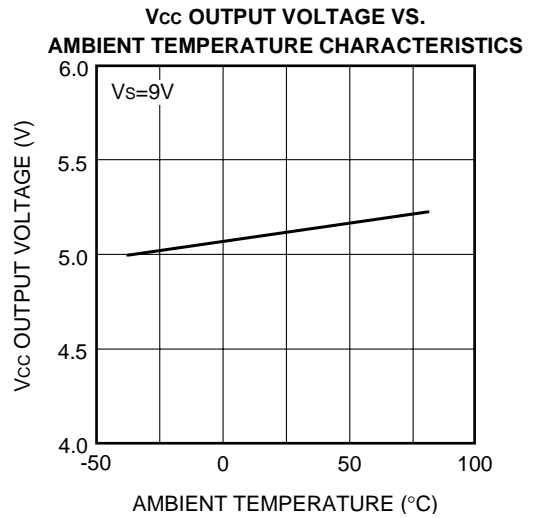
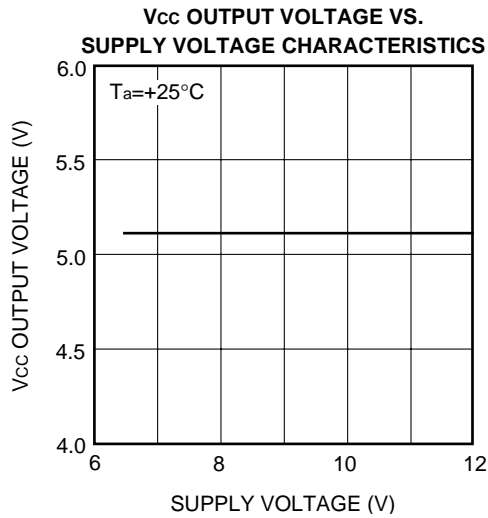

M54133FP/GP

EARTH LEAKAGE CURRENT DETECTOR

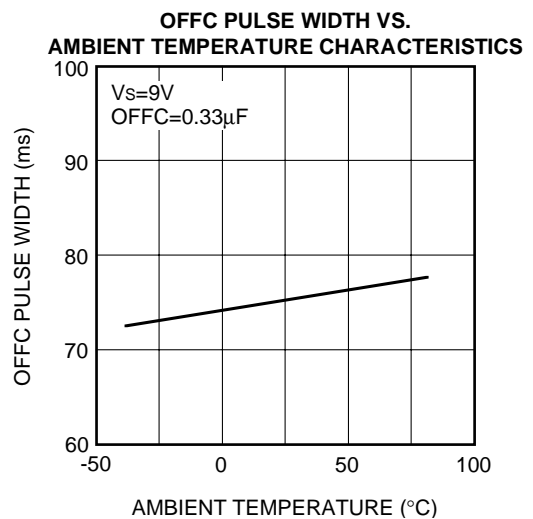
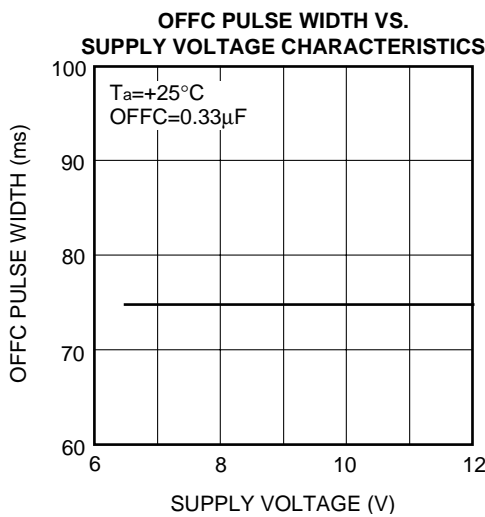
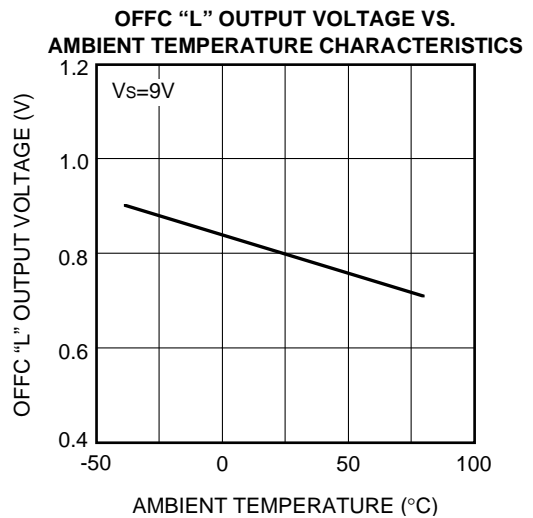
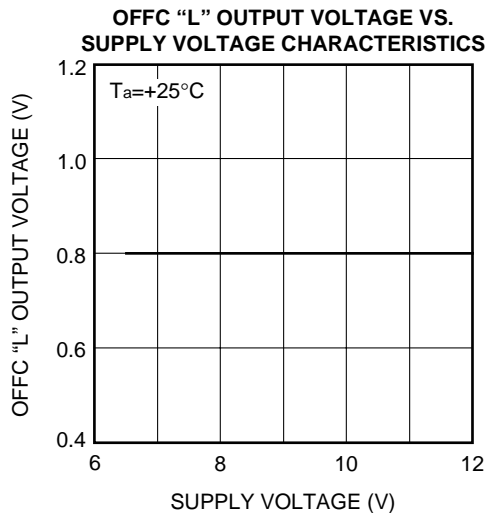
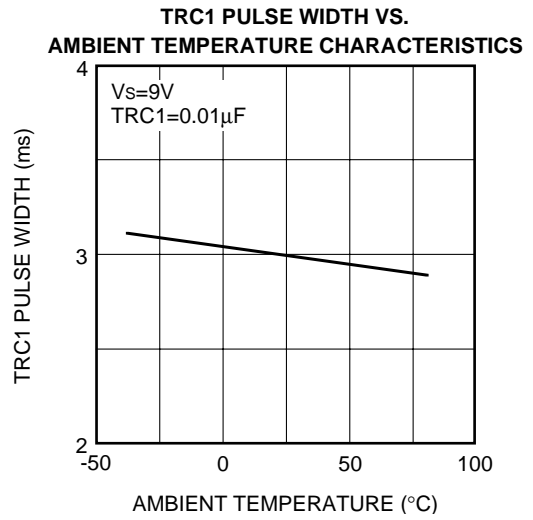
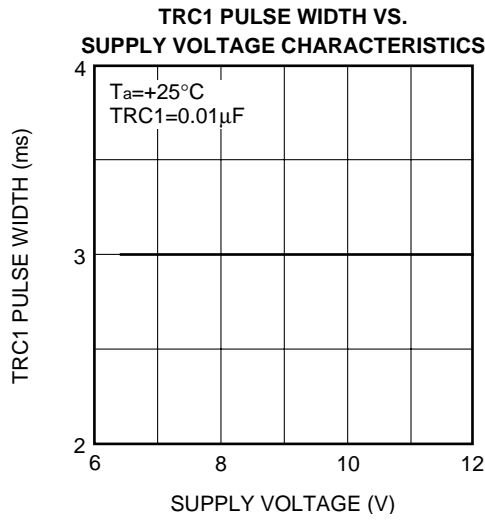

M54133FP/GP

EARTH LEAKAGE CURRENT DETECTOR

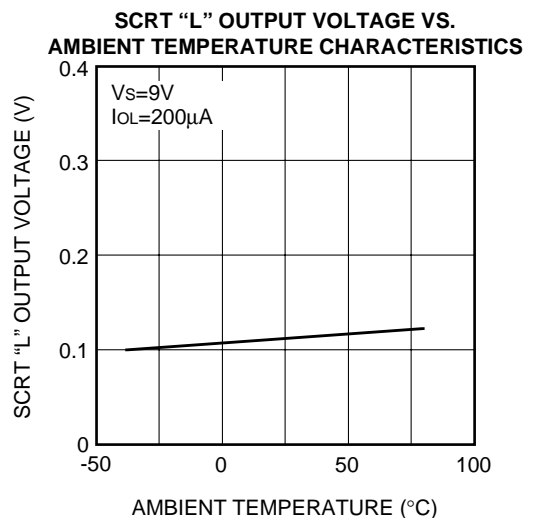
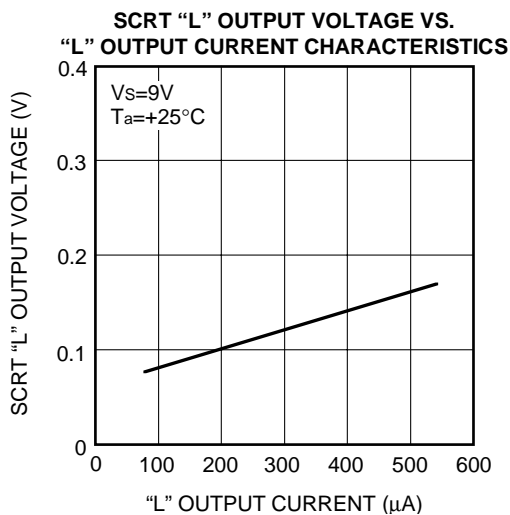
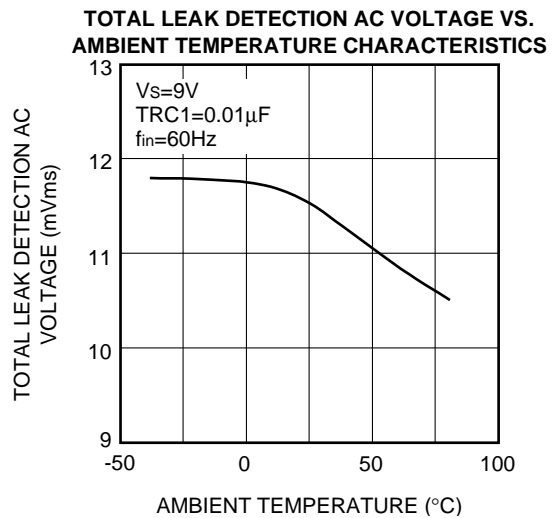
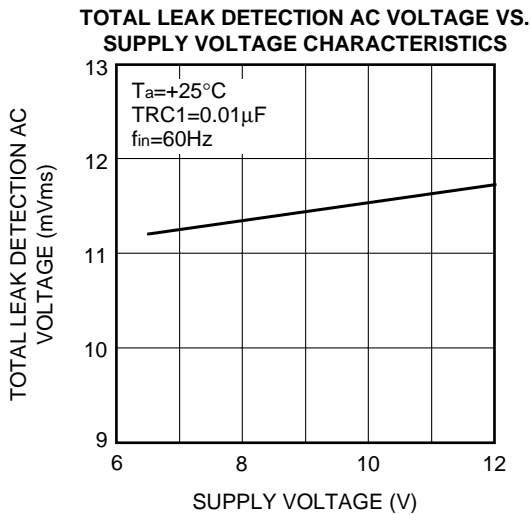
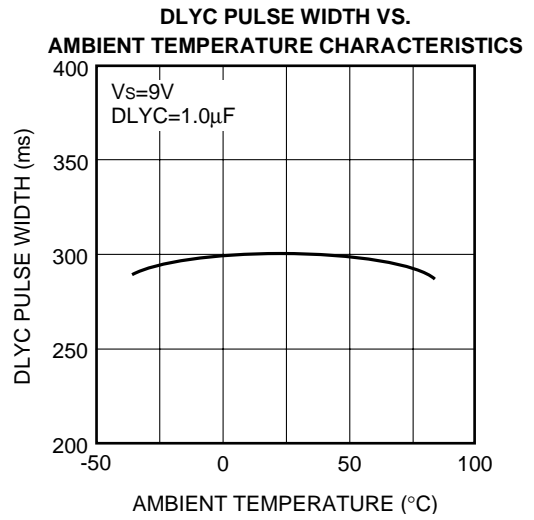
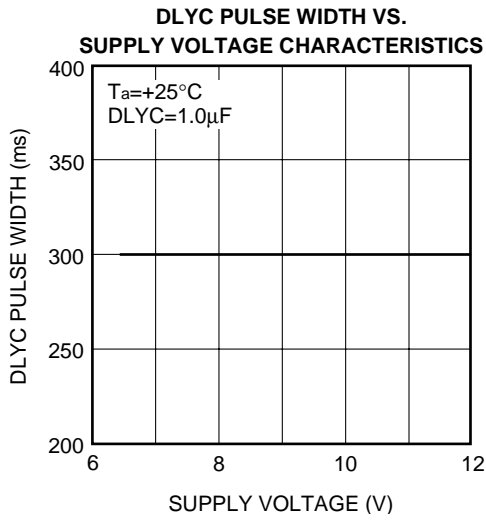

M54133FP/GP

EARTH LEAKAGE CURRENT DETECTOR

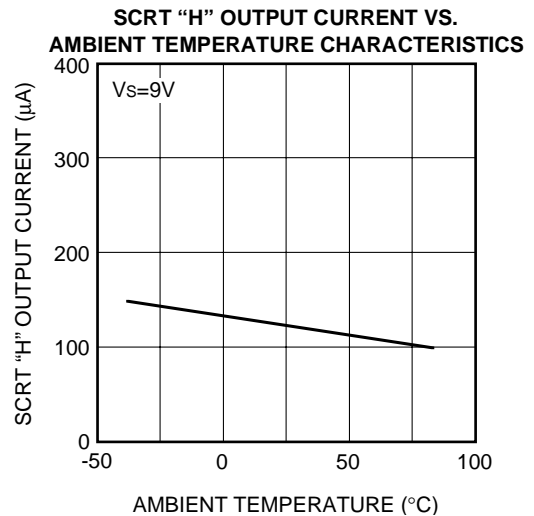
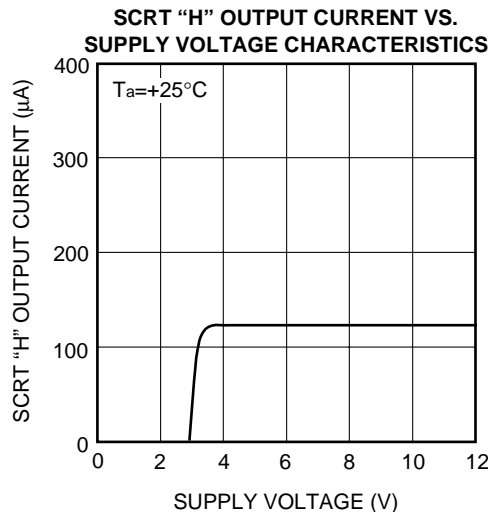
**DESCRIPTION OF PIN**

Pin No.	Name	Function
Common blocks		
⑬	Vs	Power supply
③	VCC	Output pin of the internal constant-voltage circuit. Connect decoupling capacitor.
②	IREF	Pin for connecting resistor that sets constant current through each internal circuit. About 1.3V appears.
①	GND	Grounding
Operational amplifier		
⑬	OPI-	Input pins of operational amplifier
⑮	OPI+	
⑭	C1	Pin for connecting capacitor that prevents noise from causing malfunction. Connect capacitors across IC at pins ⑬ and ⑭ and across IC at pins ⑮ and ⑭.
⑫	C2	Pin for connecting capacitor that prevents abnormal oscillations. Connect capacitor across IC at pins ⑪ and ⑫.
⑪	OPAO	Output pin of operational amplifier.
Leak detector and SCR driver circuits		
⑨	VREF	Pin for providing input reference level of leakage detection. About 2.4V appears.
⑩	ILKI	Other input pin of leakage detection.
⑤	TRC1	Pin for connecting capacitor that integrates signal output from discriminator of leak-signal input level.
⑥	TRC2	Pin for connecting capacitor to eliminate noise.
④	OFFC	Leakage input signal does not continue. Leakage is detected and SCR turn on. In these cases, this IC will be restored to the initial condition after a predetermined time. Connect capacitor that determines restore time.
⑦	DLYC	Pin for connecting capacitor that sets delay time in case of using delay function.
⑧	SCRT	Output pin for drive a SCR.

M54133FP/GP

EARTH LEAKAGE CURRENT DETECTOR

INPUT/OUTPUT EQUIVALENT CIRCUIT

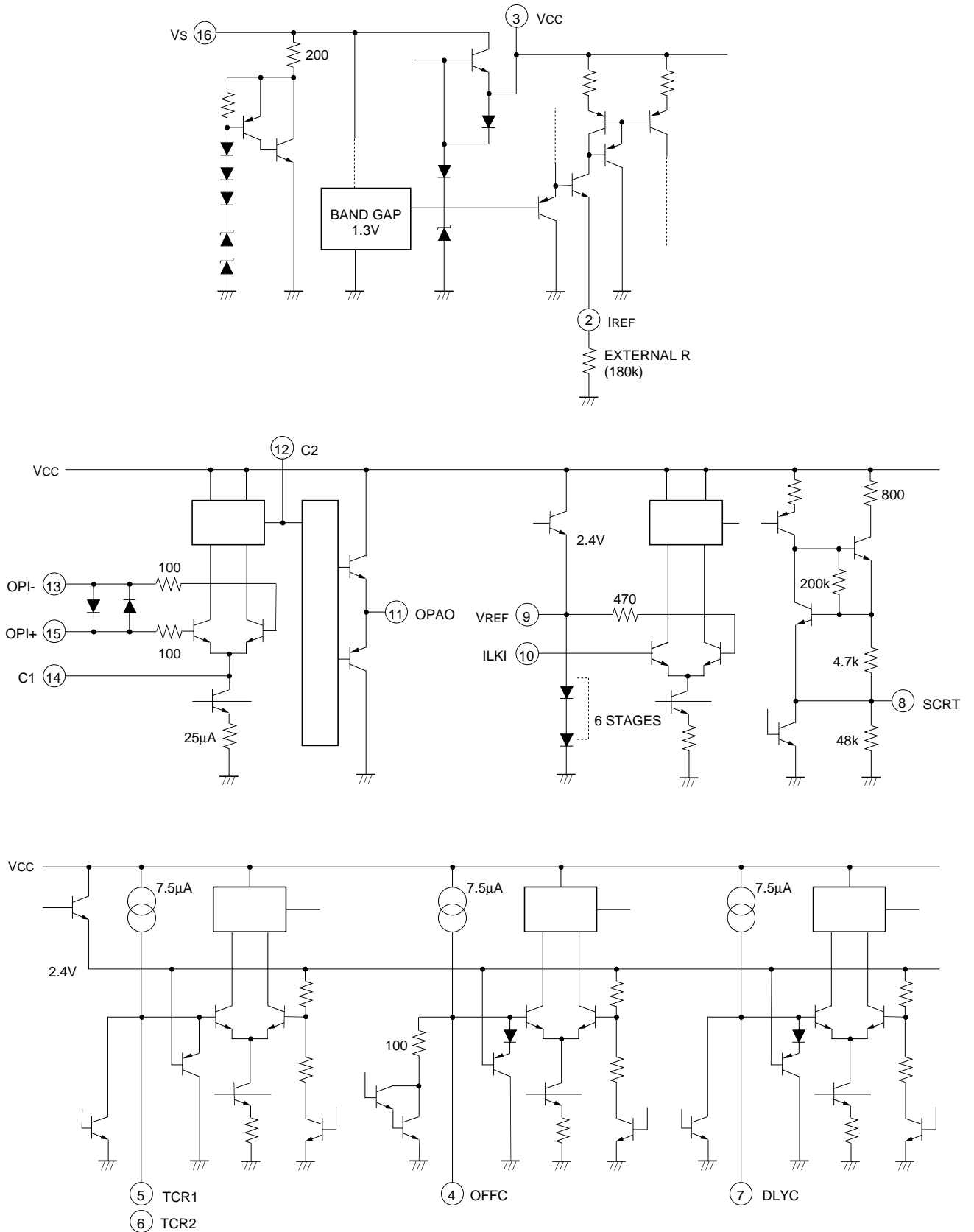

M54133FP/GP

EARTH LEAKAGE CURRENT DETECTOR

APPLICATION EXAMPLE

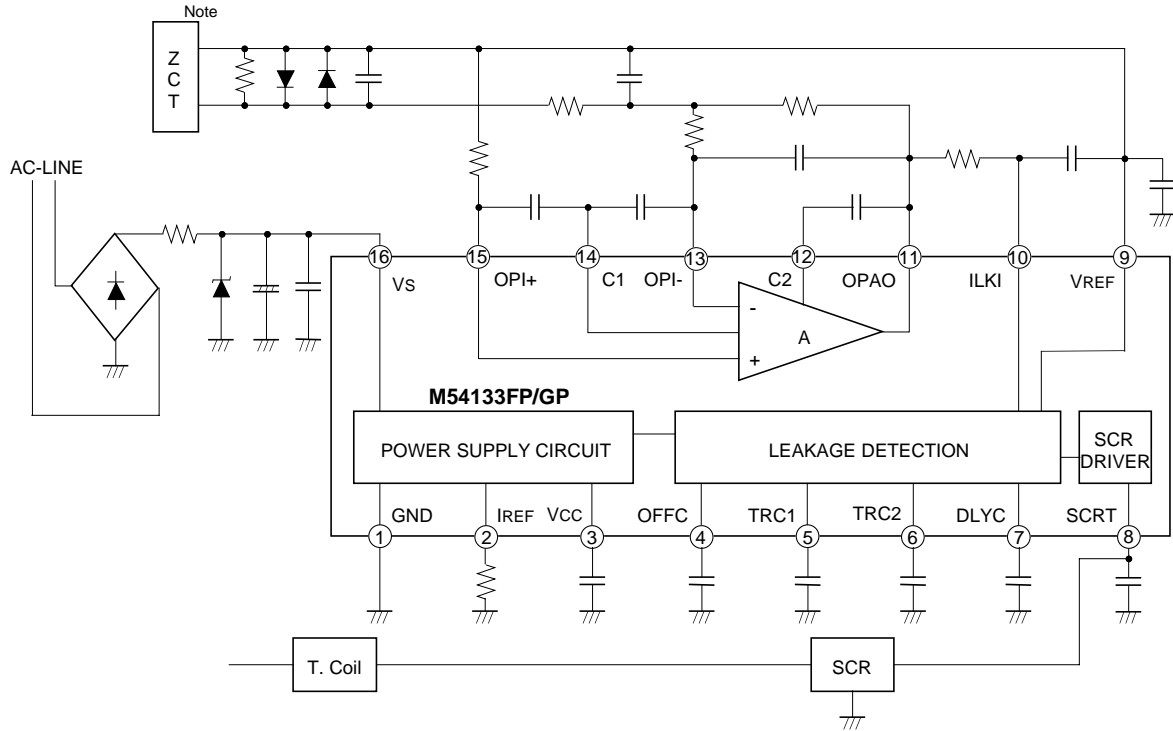

Note : MZ Core Series by Soryo Denshi Kagaku Co., Ltd (Mitsubishi Subsidiary)
Tel. +81-427-74-7813

M54133FP/GP

EARTH LEAKAGE CURRENT DETECTOR

PRECAUTION FOR APPLICATION

Described below are precautions on usage of the M54133FP and the M54133GP. Note that each precaution presents a still better example. It is advisable to review it carefully to learn optimal conditions.

1. Voltage applied to Vs

1. Fig.1 shows characteristics of circuit current I_s . (I_s characterizes clamp circuit shown in INPUT/OUTPUT equivalent circuits.) To design power supply, adapt it to IC, considering I_s characteristics.
2. Rectification for use of commercial AC line as power source.

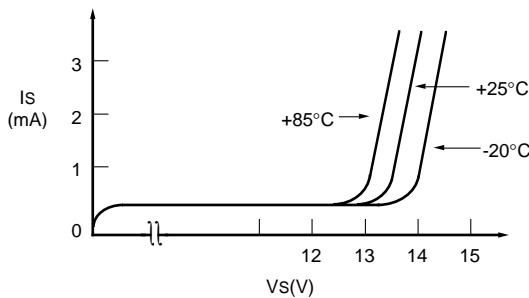
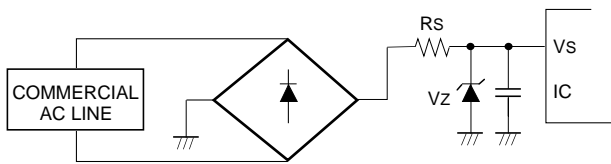

Fig. 1 CHARACTERISTICS OF Vs TO Is

- a) For V_z , select zener diode of 12V or less. (Prevent supply voltage V_s from exceeding absolute maximum rating of 15V.)
 - b) Escalated temperature may decrease supply voltage to produce large current I_s . In this case, R_s limits I_s .
3. For use of common DC power supply, set supply voltage V_s within range of 7 to 12V.

2. Resistor ($R=180k\Omega$) at I_{REF} pin

This resistor provides constant-reference-current source for IC. (Constant current source protects IC against fluctuations in supply voltage and ambient temperature.)

Since every circuit is characterized by resistance of this resistor, the use of high-precision resistor (accuracy of $\pm 2\%$) is recommended.

3. Laying out printed-circuit board

Foreign noise (from noise simulator, for example) may cause malfunctions.

To improve noise resistance, lay out printed-circuit patterns so that wirings of IC to additional capacitors and resistors can be made as short as possible.

Carefully design patterns especially for wiring capacitors to V_s of pin ⑯, V_{cc} of pin ③, and SCRT of pin ⑧.

4. Avoid SCRT output pin voltage from falling negative below GND level.

5. Reset time applicable to reset timer circuit

The M54133 has reset timer circuit of $V_L=0.7V$, $V_H=2.4V$, and $I_o=7.5\mu A$. When SCR is on, power supply path is disconnected from leak detector circuit. As shown in illustration below, disconnection may inhibit V_L from falling to 0.7V. Accordingly, reset time may get shortened. To avoid shortage, predetermine a reset time that includes extra time.

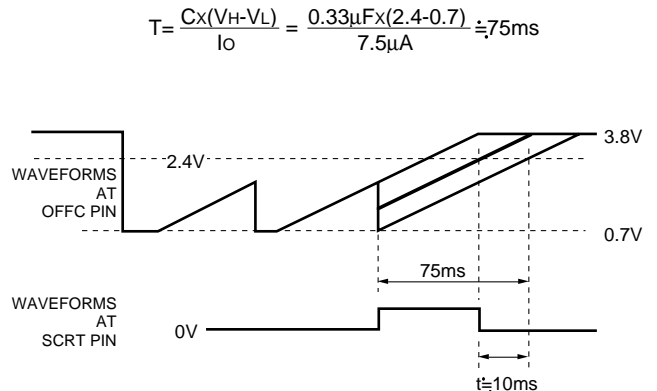

Note. Predetermined reset time may get shortened by t.