

K4N30

These Photocouplers consist of a Gallium Arsenide Infrared Emitting Diode and a Silicon NPN Photo Darlington transistor in a 6-pin package.

FEATURES

- Small Package Size
- Collector-Emitter Voltage : Min.30V
- Current Transfer Ratio : Type 1000% (at $I_F=10\text{mA}$, $V_{CE}=10\text{V}$)
- Electrical Isolation Voltage : AC2500V_{rms}
- UL Recognized File No. E107486

APPLICATIONS

- Interface between two circuits of different potential
- Telephone Line Receiver, CMOS Logic Interface
- Power Supply Regulators

DIMENSION

(Unit : mm)

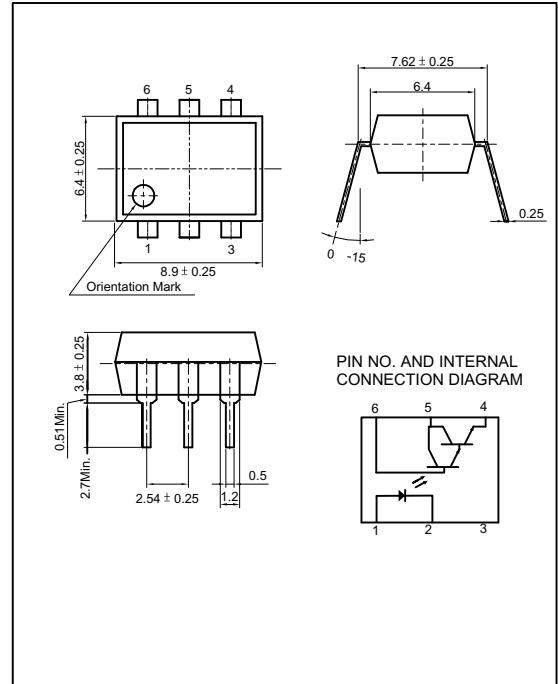

MAXIMUM RATINGS

($T_a=25^\circ\text{C}$)

Parameter		Symbol	Rating	Unit
Input	Forward Current	I_F	80	mA
	Reverse Voltage	V_R	5	V
	Peak Forward Current ^{*1}	I_{FP}	3	A
	Power Dissipation	P_D	150	mW
Output	Collector-Emitter Breakdown Voltage	BV_{CEO}	30	V
	Emitter-Collector Breakdown Voltage	BV_{ECO}	5	V
	Collector-Base Breakdown Voltage	BV_{ECO}	30	V
	Collector Current	I_C	100	mA
	Collector Power Dissipation	P_C	150	mW
Input to Output Isolation Voltage ^{*2}		V_{iso}	AC2500	V _{rms}
Storage Temperature		T_{stg}	-55~+125	
Operating Temperature		T_{opr}	-30~+100	
Lead Soldering Temperature ^{*3}		T_{sol}	260	
Total Power Dissipation		P_{tot}	250	mW

*1. Input current with 300 μs pulse width, 2% duty cycle

*2. Measured at RH=40~60% for 1min

*3. 1/16 inch form case for 10sec

K4N30

ELECTRO-OPTICAL CHARACTERISTICS

(Ta=25 , unless otherwise noted)

Parameter		Symbol	Condition	Min.	Typ.	Max.	Unit.
Input	Forward Voltage	V _F	I _F =10mA	-	1.15	1.30	V
	Reverse Current	I _R	V _R =5V	-	-	10	μA
	Capacitance	C _T	V=0, f=1MHz	-	30	-	pF
Output	Collector-Emitter Breakdown Voltage	BV _{CEO}	I _C =1mA	30	-	-	V
	Emitter-Collector Breakdown Voltage	BV _{ECO}	I _E =0.1mA	5	-	-	V
	Collector-Base Breakdown Voltage	BV _{CBO}	I _C =0.1mA	30	-	-	V
	Collector Dark Current	I _{CEO}	I _F =0, V _{CE} =10V	-	-	100	nA
	Capacitance	C _{CE}	V _{CE} =0, f=1MHz	-	10	-	pF
Coupled	Current Transfer Ratio ^{*4}	CTR	I _F =10mA, V _{CE} =10V	100	-	-	%
	Collector-Emitter Saturation Voltage	V _{CE(SAT)}	I _F =50mA, I _C =2mA	-	-	1.0	V
	Input-Output Capacitance	C _{IO}	V=0, f=1MHz	-	1	-	pF
	Input-Output Isolation Resistance	R _{IO}	RH=40~60%, V=500V	-	10 ¹¹	-	
	Turn-on Time	t _{on}	V _{CC} =10V, R _L =100	-	-	5	μs
	Turn-off Time	t _{off}	I _C =50mA, I _F =200mA	-	-	40	μs

*4. CTR=(I_C/I_F) X 100 (%)

K4N30

Forward Current vs. Ambient Temperature

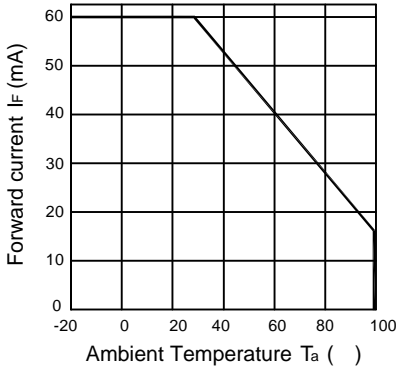

Collector Power Dissipation vs. Ambient Temperature

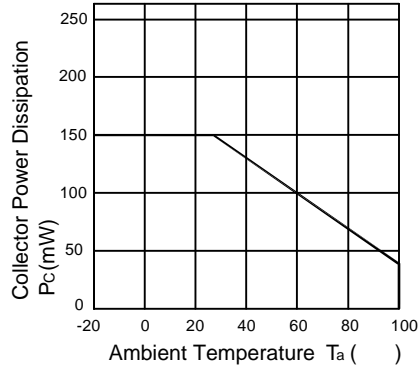

Forward Current vs. Forward Voltage

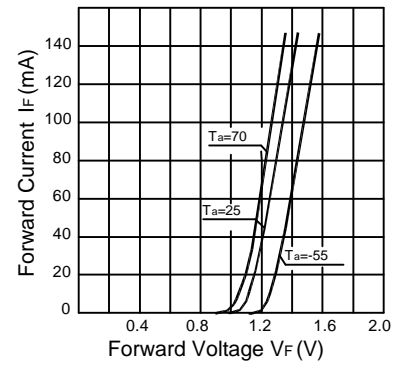

Collector Current vs. Collector-Emitter Voltage

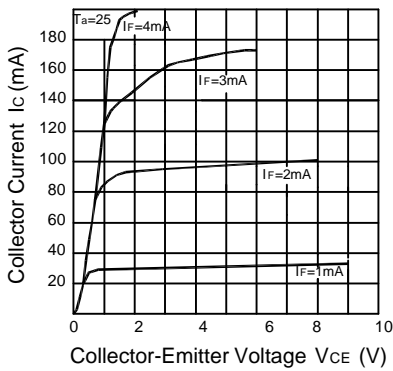

Dark Current vs. Ambient Temperature

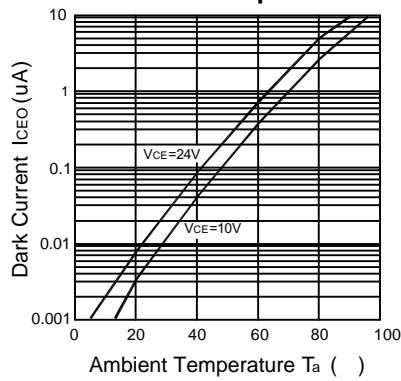

Collector Current vs. Forward Current

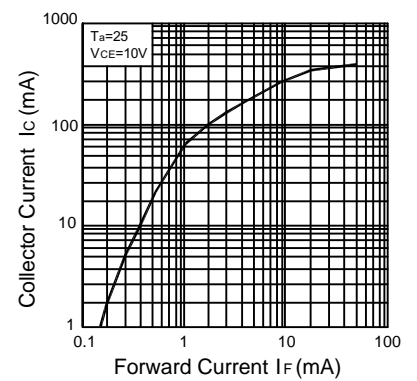

Switching Time Test Circuit

