

Isolated Triac 16 Amperes/400-600 Volts

OUTLINE DRAWING

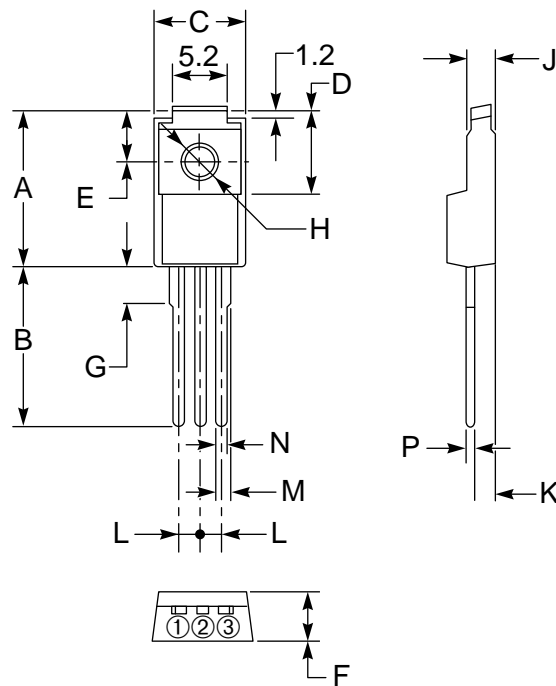

CONNECTION DIAGRAM

- ① T1 TERMINAL
- ② T2 TERMINAL
- ③ GATE TERMINAL

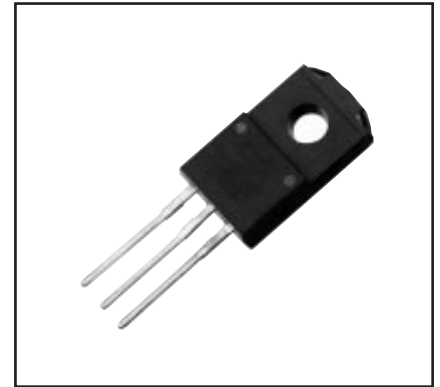
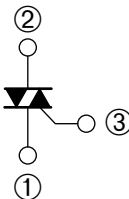

Description:

A triac is a solid state silicon AC switch which may be gate triggered from an off-state to an on-state for either polarity of applied voltage.

Features:

- Full Molded Isolation Package
- Glass Passivation
- Low Off-state Leakage
- 1500 V_{RMS} Isolation Voltage
- UL Card
- Excellent Surge Capability
- Low On-state Voltage
- Selected for Inductive Loads

Applications:

- AC Switch
- Motor Controls
- Lighting
- TV
- SSR

Ordering Information:

Example: Select the complete eight, nine or ten digit part number you desire from the table - i.e. BCR16PM-8 is a 400 Volt, 16 Ampere Triac.

Type	V _{DRM} Volts	Code	Inductive Load*
BCR16PM	400	-8	L
	600	-12	

*For inductive load, add L.

Outline Drawing (Conforms to TO-220F)

Dimensions	Inches	Millimeters
A	0.67	17.0
B	0.49 Min.	12.5 Min.
C	0.39	10.0
D	0.33	8.5
E	0.20	5.0
F	0.18	4.5
G	0.14	3.6

Dimensions	Inches	Millimeters
H	0.126 ± 0.008	Dia.3.2 ± 0.2 Dia.
J	0.11	2.8
K	0.102	2.6
L	0.10	2.5
M	0.039	1.0
N	0.031	0.8
P	0.020	0.5

BCR16PM

Isolated Triac

16 Amperes/400-600 Volts

Absolute Maximum Ratings, $T_a = 25^\circ\text{C}$ unless otherwise specified

Ratings	Symbol	BCR16PM-8	BCR16PM-12	Units
Repetitive Peak Off-state Voltage	V_{DRM}	400	600	Volts
Non-repetitive Peak Off-state Voltage	V_{DSM}	500	720	Volts
On-state Current, $T_c = 71^\circ\text{C}$	$I_T(\text{RMS})$	16	16	Amperes
Non-repetitive Peak Surge, One Cycle (60 Hz)	I_{TSM}	160	160	Amperes
I^2t for Fusing, $t = 8.3$ msec	I^2t	106.5	106.5	A^2sec
Peak Gate Power Dissipation, 20 μsec	P_{GM}	5	5	Watts
Average Gate Power Dissipation	$P_{G(\text{avg})}$	0.5	0.5	Watts
Peak Gate Current	I_{GM}	2	2	Amperes
Peak Gate Voltage	V_{GM}	10	10	Volts
Storage Temperature	T_{stg}	-40 to 125	-40 to 125	$^\circ\text{C}$
Operating Junction Temperature	T_j	-40 to 125	-40 to 125	$^\circ\text{C}$
Isolation Voltage	V_{iso}	1500	1500	Volts
Weight	–	2	2	Grams

Electrical and Thermal Characteristics, $T_j = 25^\circ\text{C}$ unless otherwise specified

Characteristics	Symbol	Test Conditions (Trigger Mode)				BCR16PM			Units
		V_D	R_L	R_G	T_j	Min.	Typ.	Max.	
Gate Parameters									
DC Gate Trigger Current									
MT2+ Gate+	$I_{FGT I}$	6V	6 Ω	330 Ω	25 $^\circ\text{C}$	–	–	30	mA
MT2+ Gate–	$I_{RGT I}$	6V	6 Ω	330 Ω	25 $^\circ\text{C}$	–	–	30	mA
MT2– Gate–	$I_{RGT III}$	6V	6 Ω	330 Ω	25 $^\circ\text{C}$	–	–	30	mA
DC Gate Trigger Voltage									
MT2+ Gate+	$V_{FGT I}$	6V	6 Ω	330 Ω	25 $^\circ\text{C}$	–	–	1.5	Volts
MT2+ Gate–	$V_{RGT I}$	6V	6 Ω	330 Ω	25 $^\circ\text{C}$	–	–	1.5	Volts
MT2– Gate–	$V_{RGT III}$	6V	6 Ω	330 Ω	25 $^\circ\text{C}$	–	–	1.5	Volts
DC Gate Non-trigger Voltage									
All	V_{GD}	1/2 V_{DRM}	–	–	125 $^\circ\text{C}$	0.2	–	–	Volts

Characteristics	Symbol	Test Conditions	Min.	Typ.	Max.	Units
Thermal Resistance, Junction-to-case	$R_{th(j-c)}$	–	–	–	3	$^\circ\text{C}/\text{W}$
Voltage – Blocking State Repetitive Off-state Current	I_{DRM}	Gate Open Circuited, $V_D = V_{DRM}$, $T_j = 125^\circ\text{C}$	–	–	2	mA
Current – Conducting State Peak On-state Voltage	V_{TM}	$T_c = 25^\circ\text{C}$, $I_{TM} = 25\text{A}$	–	–	1.6	Volts
Critical Rate-of-rise of Commutating Off-state Voltage (Commutating dv/dt) ▲ for inductive load (L) (Switching)	$(dv/dt)_c$	–	–	–	–	$\text{V}/\mu\text{s}$



Powerex, Inc., 200 Hillis Street, Youngwood, Pennsylvania 15697-1800 (412) 925-7272

BCR16PM
Isolated Triac
 16 Amperes/400-600 Volts

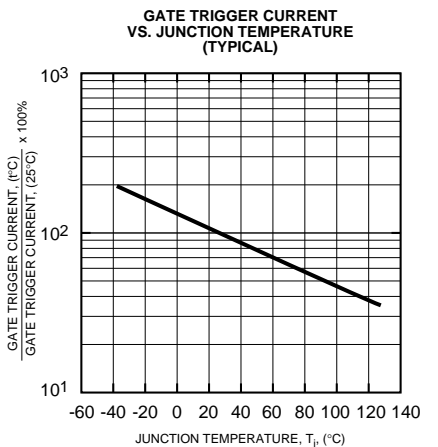
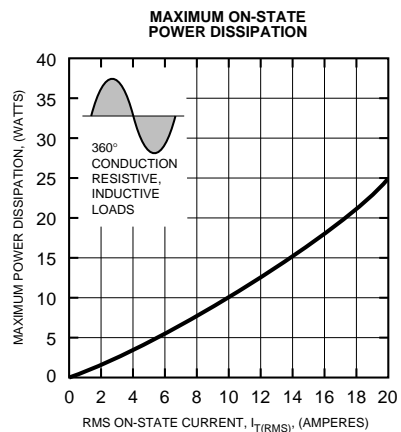
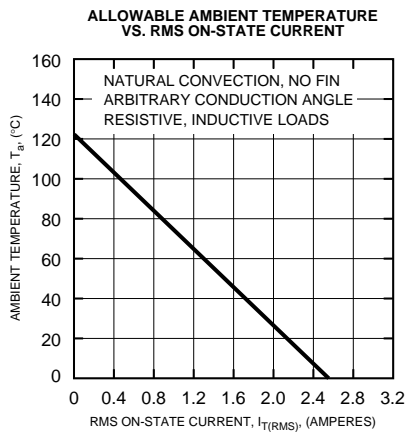
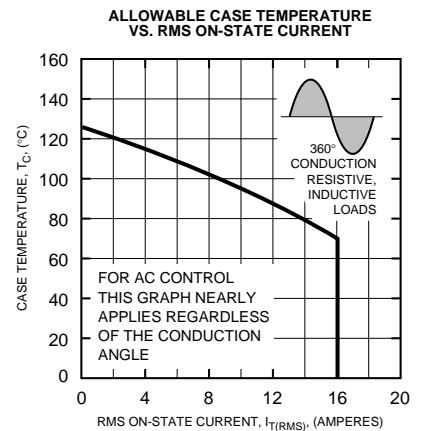
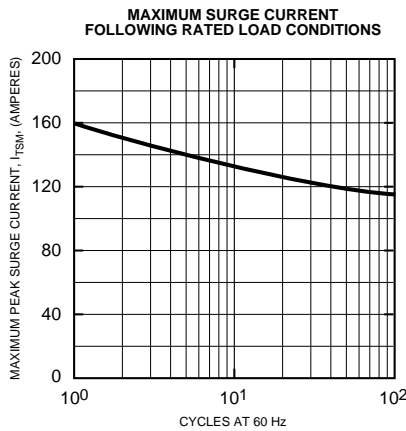
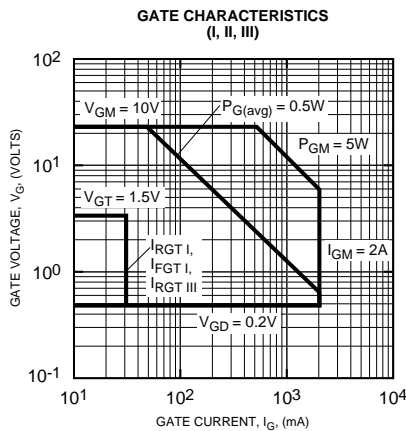
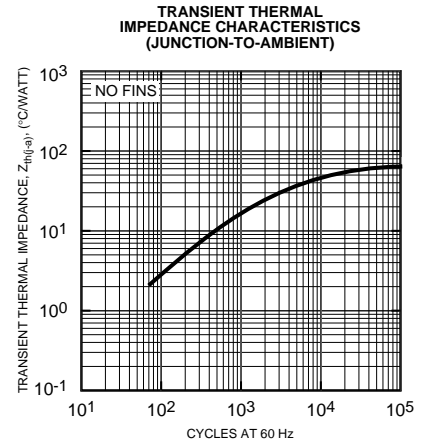
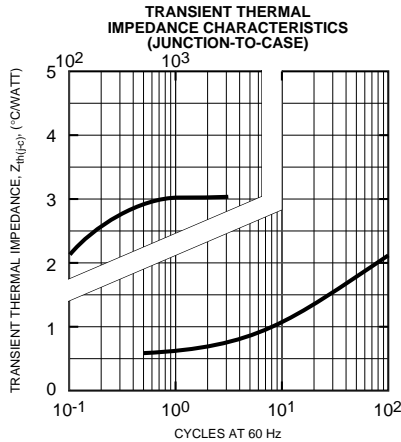
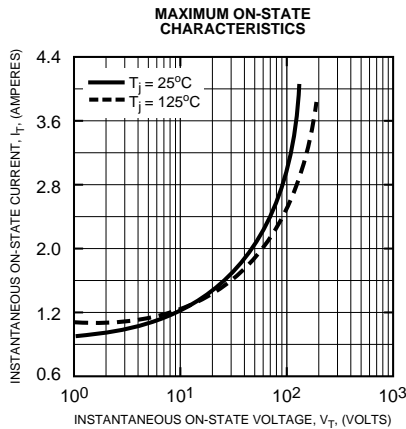

BCR16PM

Isolated Triac

16 Amperes/400-600 Volts

GATE TRIGGER VOLTAGE VS. JUNCTION TEMPERATURE (TYPICAL)

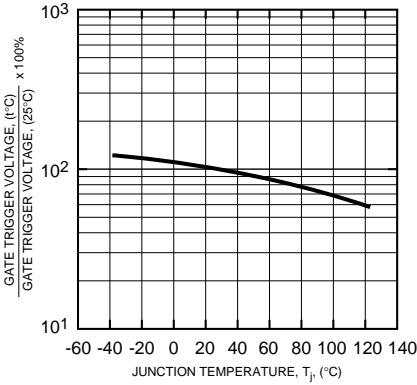

BREAKOVER VOLTAGE VS. JUNCTION TEMPERATURE (TYPICAL)

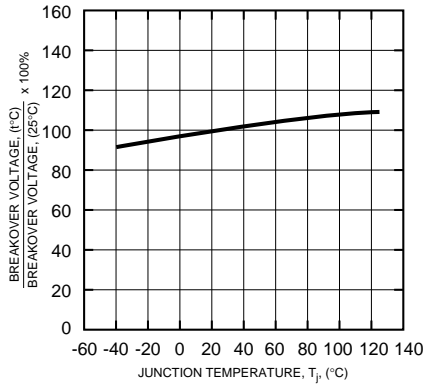

BREAKOVER VOLTAGE VS. RATE OF RISE OF OFF-STATE VOLTAGE (TYPICAL)

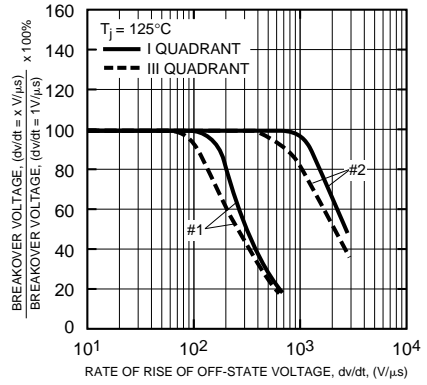

REPETITIVE PEAK OFF-STATE CURRENT VS. JUNCTION TEMPERATURE (TYPICAL)

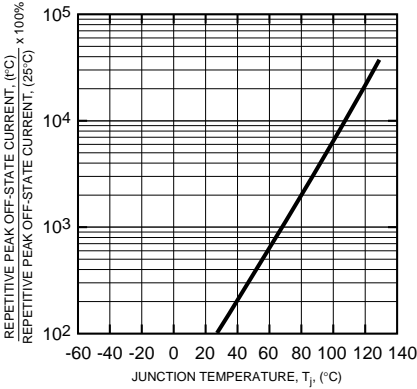

COMMUTATION CHARACTERISTICS (TYPICAL)

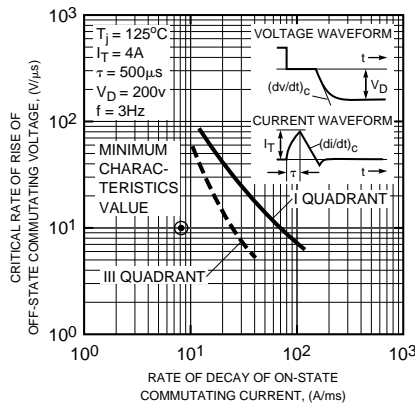

GATE TRIGGER CURRENT VS. GATE CURRENT PULSE WIDTH (TYPICAL)

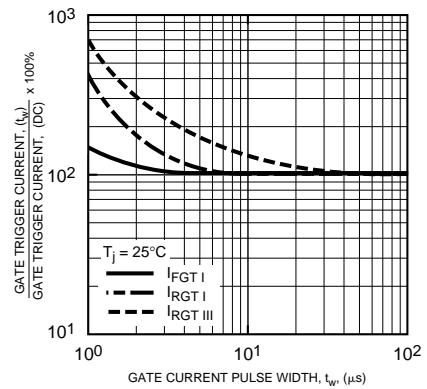

GATE TRIGGER CHARACTERISTICS TEST CIRCUITS

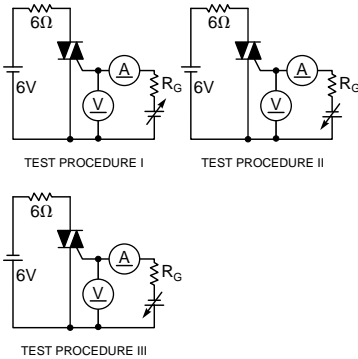

Commutating dv/dt, (dv/dt)_c

Δ Part Number	V _{DRM} (Volts)	Load Type	Minimum
BCR16PM-8L	400	L	10
BCR16PM-12L	600	L	10

Commutating Voltage & Current Waveform (Inductive Load)

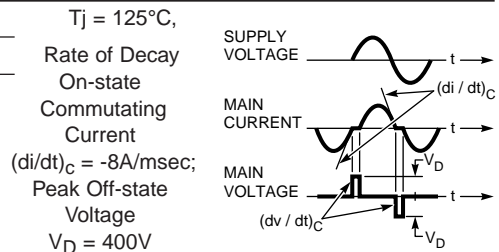

T_j = 125°C,
Rate of Decay
On-state
Commutating
Current
(di/dt)_c = -8A/msec;
Peak Off-state
Voltage
V_D = 400V