

M/A-COM 3Volt Voltage Variable Attenuator 25 dB, DC - 2.5 GHz

Features

- Single Voltage Control 0 to -3 Volts
- 25 dB Attenuation Range at 0.9 GHz
- Low DC Power Consumption
- Low Cost SOT-25 Plastic Package
- Tape and Reel Packaging Available

Description

M/A-COM's AT-255 is a GaAs MMIC voltage variable absorptive attenuator in a low cost SOT-25 surface mount plastic package. The AT-255 is ideally suited for use where variable attenuation fine tuning and very low power consumption are required.

Typical applications include radio, cellular, GPS equipment and automatic gain/level control circuits.

The AT-255 is fabricated using a mature 1-micron GaAs MESFET process. The process features full chip passivation for increased performance and reliability.

Ordering Information

Part Number	Package
AT-255	SOT-25 Plastic
AT-255TR	Forward Tape and Reel ¹

1. Reference Application Note M513 for reel size information.

SOT-25

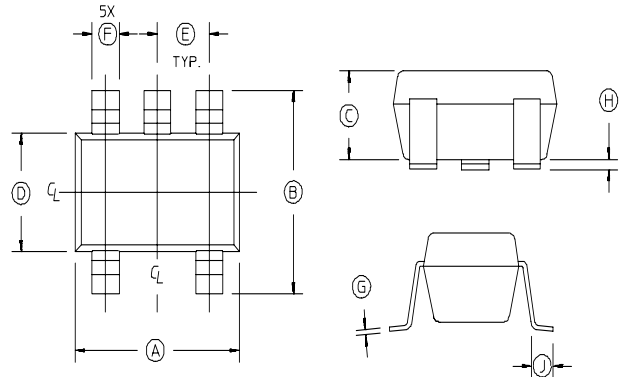

Note: 1. Leads Coplanarity should be 0.003 (0.08) max.

DIM	INCHES		MILLIMETERS	
	MIN	MAX	MIN	MAX
A	.106	.122	2.70	3.10
B	.100	.118	2.54	3.00
C	—	.051	—	1.30
D	.063 REF.		1.60 REF.	
E	.032	.043	.80	1.10
F	.014	.020	.35	.50
G	.003	—	.08	—
H	.000	.006	.00	.15
J	.018 REF.		.45 REF.	

Electrical Specifications: T_A = +25°C¹

Parameter	Test Conditions	Units	Min.	Typ.	Max.
Insertion Loss	DC - 2.0 GHz	dB		3.6	4.2
Attenuation	DC - 1.0 GHz	dB	23	25	
	1.0 - 2.0 GHz	dB	18	20	
Flatness (Peak-to-Peak)	DC - 1.0 GHz	dB		±7	±10
	1.0 - 2.0 GHz	dB		±5	±8
VSWR	DC - 2.0 GHz			3:1	
T _{rise} , T _{fall}	10% to 90% RF, 90% to 10% RF	nS		10	
T _{on} , T _{off}	50% Control to 90% RF, Control to 10% RF	nS		20	
Transients	In-band	mV		10	

1. All measurements at 1 GHz in a 50Ω system unless otherwise specified. Insertion Loss varies 0.003 dB/°C.

Specifications subject to change without notice.

V 4.0

- North America: Tel. (800) 366-2266, Fax (800) 618-8883
- Asia/Pacific: Tel.+81-44-844-8296, Fax +81-44-844-8298
- Europe: Tel. +44 (1344) 869 595, Fax+44 (1344) 300 020

tyco Electronics

M/A-COM

Visit www.macom.com for additional data sheets and product information.

Absolute Maximum Ratings¹

Parameter	Absolute Maximum
Maximum Input Power	+21 dBm
Control Voltage V_C	-8V, +0.5V
Operating Temperature	-40°C to +85°C
Storage Temperature	-65°C to +150°C

1. Exceeding any one or a combination of these limits may cause permanent damage.

Functional Schematic¹

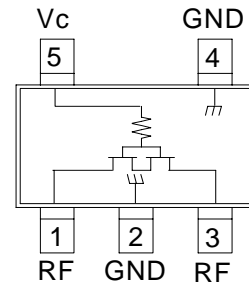

1. $V_{CC} = 0 V_{DC}$ to $-3 V_{DC}$ @ 50 μA max.

Typical Performance Curves

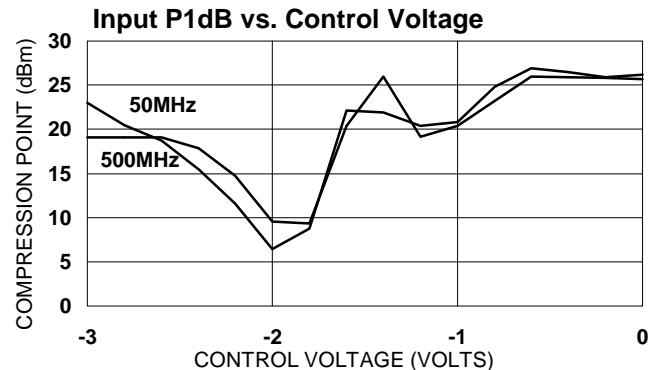
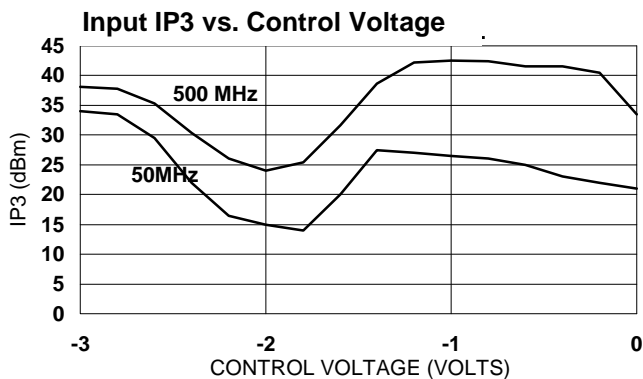
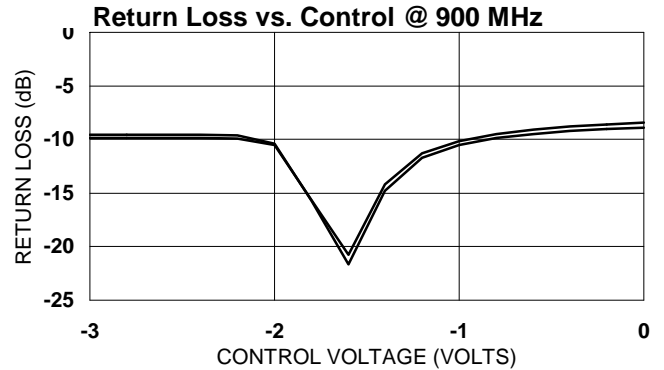
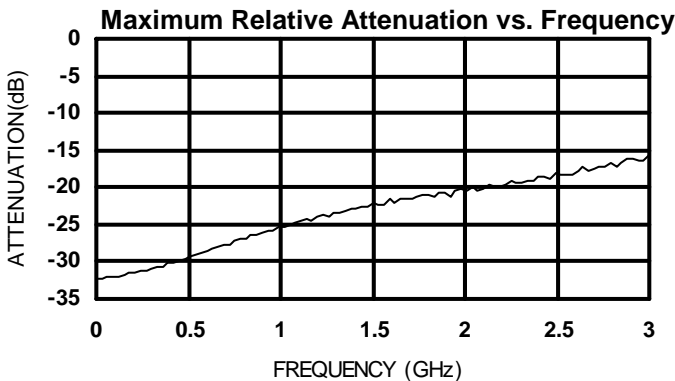
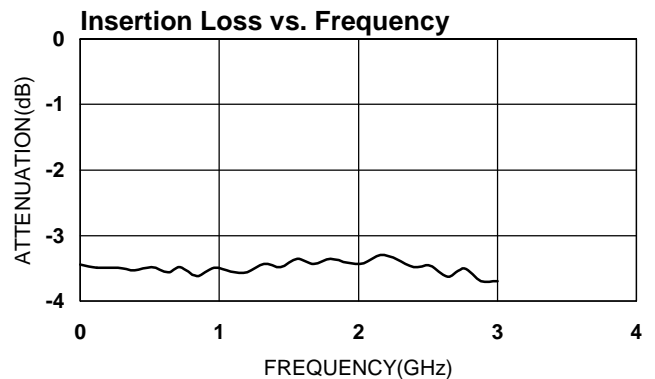
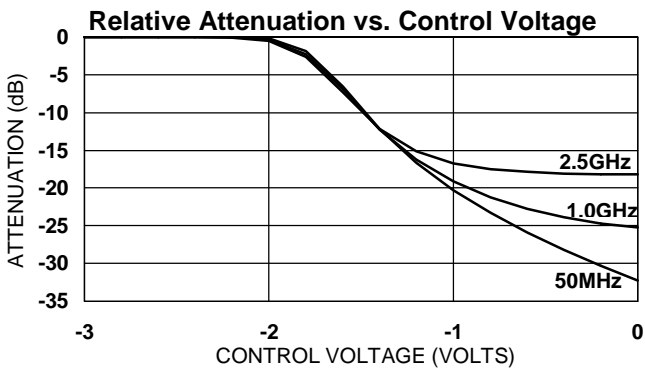

Specifications subject to change without notice.

V 4.0

■ North America: Tel. (800) 366-2266, Fax (800) 618-8883
 ■ Asia/Pacific: Tel.+81-44-844-8296, Fax +81-44-844-8298
 ■ Europe: Tel. +44 (1344) 869 595, Fax+44 (1344) 300 020

Visit www.macom.com for additional data sheets and product information.