

S6785G

HIGH SPEED SWITCHING AND CONTROL APPLICATIONS

MAXIMUM RATINGS

CHARACTERISTIC	SYMBOL	RATING	UNIT
Repetitive Peak Off-State Voltage and Repetitive Peak Reverse Voltage	V_{DRM} V_{RRM}	400	V
Non-Repetitive Peak Reverse Voltage (Non-Repetitive <5ms, $T_j = 0\sim 125^\circ\text{C}$)	V_{RSM}	500	V
Average On-State Current (Half Sine Waveform)	$I_T (AV)$	3	A
R.M.S On-State Current	$I_T (RMS)$	4.7	A
Peak One Cycle Surge On-State Current (Non-Repetitive)	I_{TSM}	60 (50Hz) 66 (60Hz)	A
I^2t Limit Value	I^2t	18	A^2s
Peak Gate Power Dissipation	P_{GM}	5	W
Average Gate Power Dissipation	$P_G (AV)$	0.5	W
Peak Forward Gate Voltage	V_{FGM}	10	V
Peak Reverse Gate Voltage	V_{RGM}	-6	V
Peak Forward Gate Current	I_{GM}	2	A
Junction Temperature	T_j	-40~125	$^\circ\text{C}$
Storage Temperature Range	T_{stg}	-40~125	$^\circ\text{C}$

Unit: mm

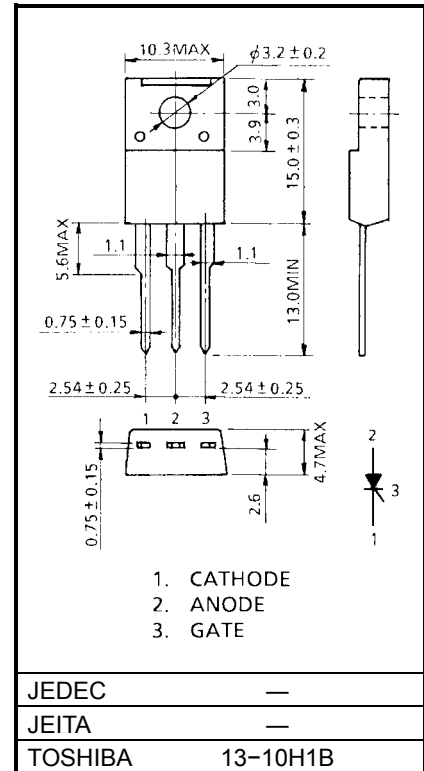

Weight: 1.7 g

ELECTRICAL CHARACTERISTICS (Ta = 25°C)

CHARACTERISTIC	SYMBOL	TEST CONDITION	MIN.	MAX.	UNIT
Repetitive Peak Off-State Current and Repetitive Peak Reverse Current	I_{DRM}	$V_{DRM} = V_{RRM} = \text{Rated}, T_j = 125^\circ\text{C}$	—	1.0	mA
	I_{RRM}		—	2.0	
Peak On-State Voltage	V_{TM}	$I_{TM} = 20\text{A}$	—	2.0	V
Gate Trigger Voltage	V_{GT}	$V_D = 6\text{V}, R_L = 10\Omega$	—	1.5	V
Gate Trigger Current	I_{GT}		—	25.0	mA
Gate Non-Trigger Voltage	V_{GD}	$V_D = \text{Rated}, T_c = 100^\circ\text{C}$	0.2	—	V
Gate Non-Trigger Current	I_{GD}		0.2	—	mA
Turn-On Time	t_{gt}	$V_D = \text{Rated}, I_{TM} = 3\text{A}, I_G = 120\text{mA}, t_{gr} < 1\mu\text{s}$	—	3.0	μs
Turn-Off Time	t_q	$V_D = \text{Rated}, I_{TM} = 20\text{A}, V_G = -2.5\text{V}, dv/dt \geq 100\text{V}/\mu\text{s}, T_c = 90^\circ\text{C}$	—	3.5	μs
Critical Rate of Rise of Off-State Voltage	dv/dt	$V_D = \text{Rated}, R_{GK} = 100\Omega, V_G = -2.5\text{V}, T_c = 125^\circ\text{C}, \text{Exponential Rise}$	100	—	V / μs
Holding Current	I_H	$R_L = 10\Omega$	—	80.0	mA
Thermal Resistance	$R_{th(j-c)}$	Junction to Case, DC	—	4.0	$^\circ\text{C} / \text{W}$

MARKING

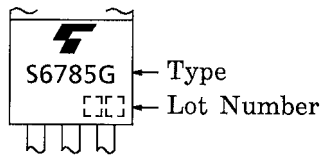

NUMBER	SYMBOL		MARK
*1	TYPE	S6785G	S6785G
*2	Lot Number 		Example 8A : January 1998 8B : February 1998 8L : December 1998

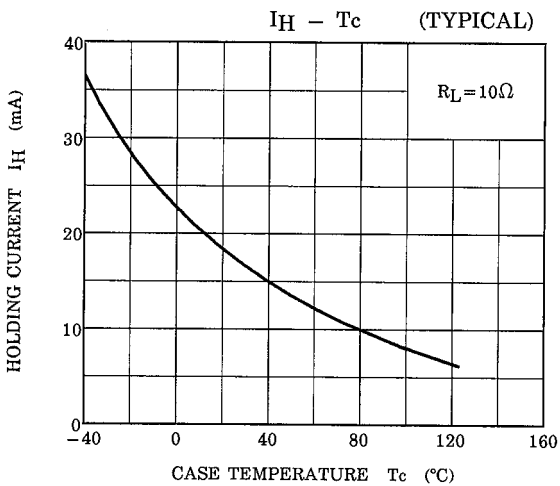
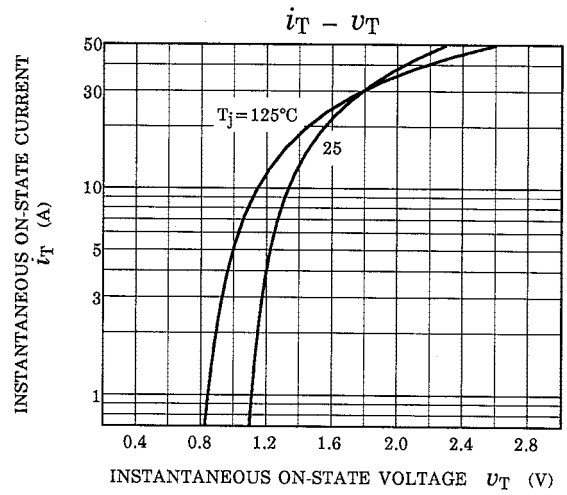
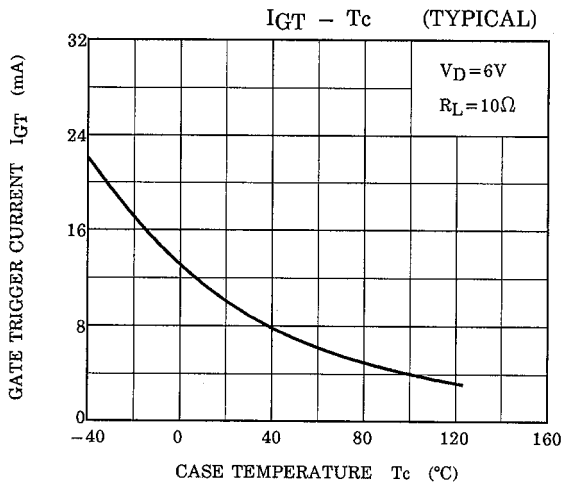
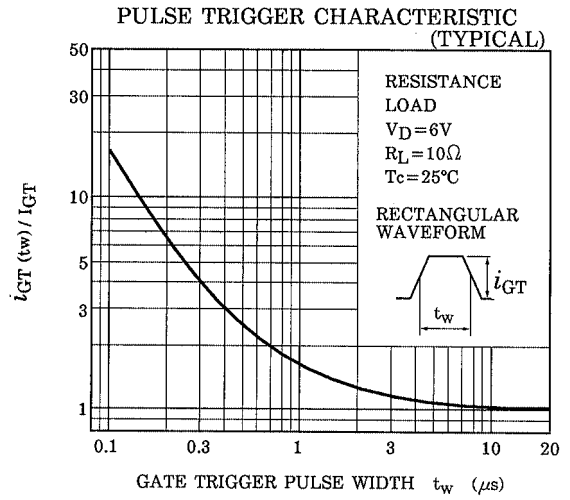
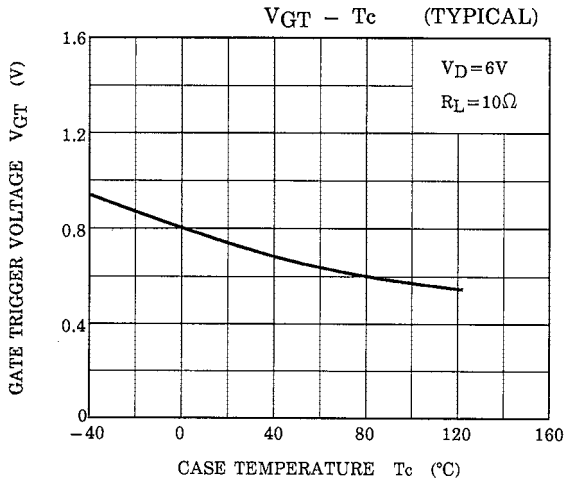

RESTRICTIONS ON PRODUCT USE

000707EAA

- TOSHIBA is continually working to improve the quality and reliability of its products. Nevertheless, semiconductor devices in general can malfunction or fail due to their inherent electrical sensitivity and vulnerability to physical stress. It is the responsibility of the buyer, when utilizing TOSHIBA products, to comply with the standards of safety in making a safe design for the entire system, and to avoid situations in which a malfunction or failure of such TOSHIBA products could cause loss of human life, bodily injury or damage to property.
In developing your designs, please ensure that TOSHIBA products are used within specified operating ranges as set forth in the most recent TOSHIBA products specifications. Also, please keep in mind the precautions and conditions set forth in the "Handling Guide for Semiconductor Devices," or "TOSHIBA Semiconductor Reliability Handbook" etc..
- The TOSHIBA products listed in this document are intended for usage in general electronics applications (computer, personal equipment, office equipment, measuring equipment, industrial robotics, domestic appliances, etc.). These TOSHIBA products are neither intended nor warranted for usage in equipment that requires extraordinarily high quality and/or reliability or a malfunction or failure of which may cause loss of human life or bodily injury ("Unintended Usage"). Unintended Usage include atomic energy control instruments, airplane or spaceship instruments, transportation instruments, traffic signal instruments, combustion control instruments, medical instruments, all types of safety devices, etc.. Unintended Usage of TOSHIBA products listed in this document shall be made at the customer's own risk.
- The information contained herein is presented only as a guide for the applications of our products. No responsibility is assumed by TOSHIBA CORPORATION for any infringements of intellectual property or other rights of the third parties which may result from its use. No license is granted by implication or otherwise under any intellectual property or other rights of TOSHIBA CORPORATION or others.
- The information contained herein is subject to change without notice.