

Major Ratings and Characteristics

Characteristics	MBR350 MBR360	Units
$I_{F(AV)}$ Rectangular waveform	3.0	A
V_{RRM}	50/60	V
I_{FSM} @ $t_p = 5 \mu s$ sine	460	A
V_F @ 3 Apk, $T_J = 25^\circ C$	0.73	V
T_J	-40 to 150	$^\circ C$

Description/ Features

The MBR350, MBR360 axial leaded Schottky rectifier has been optimized for very low forward voltage drop, with moderate leakage. Typical applications are in switching power supplies, converters, free-wheeling diodes, and reverse battery protection.

- Low profile, axial leaded outline
- High purity, high temperature epoxy encapsulation for enhanced mechanical strength and moisture resistance
- Very low forward voltage drop
- High frequency operation
- Guard ring for enhanced ruggedness and long term reliability

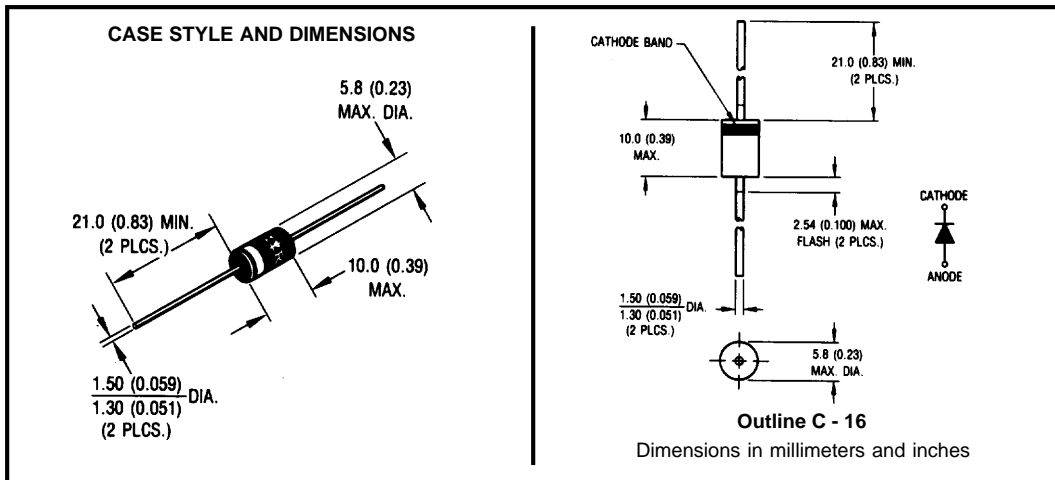

Voltage Ratings

Part number	MBR350	MBR360
V _R Max. DC Reverse Voltage (V)	50	60
V _{RWM} Max. Working Peak Reverse Voltage (V)		

Absolute Maximum Ratings

Parameters	Value	Units	Conditions
I _{F(AV)} Max. Average Forward Current * See Fig. 4	3.0	A	50% duty cycle @ T _L = 50°C, rectangular wave form
I _{FSM} Max. Peak One Cycle Non-Repetitive Surge Current * See Fig. 6	460	A	5µs Sine or 3µs Rect. pulse
	80		10ms Sine or 6ms Rect. pulse
E _{AS} Non-Repetitive Avalanche Energy	5.0	mJ	T _J = 25 °C, I _{AS} = 1 Amps, L = 10 mH
I _{AR} Repetitive Avalanche Current	1.0	A	Current decaying linearly to zero in 1 µsec Frequency limited by T _J max. V _A = 1.5 x V _R typical

Electrical Specifications

Parameters	Value	Units	Conditions
V _{FM} Max. Forward Voltage Drop * See Fig. 1 (1)	0.58	V	@ 1.0A
	0.73	V	@ 3.0A
	1.06	V	@ 9.4A
	0.49	V	@ 1.0A
	0.64	V	@ 3.0A
	0.89	V	@ 9.4A
I _{RM} Max. Reverse Leakage Current * See Fig. 2 (1)	0.6	mA	T _J = 25 °C
	8	mA	T _J = 100 °C
	15	mA	T _J = 125 °C
C _T Typical Junction Capacitance	190	pF	V _R = 5V _{DC} (test signal range 100Khz to 1Mhz) 25°C
L _S Typical Series Inductance	9.0	nH	Measured lead to lead 5mm from package body
dv/dt Max. Voltage Rate of Change	10000	V/µs	(Rated V _R)

(1) Pulse Width < 300µs, Duty Cycle <2%

Thermal-Mechanical Specifications

Parameters	Value	Units	Conditions
T _J Max. Junction Temperature Range(*)	-40 to 150	°C	
T _{stg} Max. Storage Temperature Range	-40 to 150	°C	
R _{thJL} Typical Thermal Resistance Junction to Lead (**)	30	°C/W	DC operation (* See Fig. 4)
wt Approximate Weight	1.2 (0.042)	g (oz.)	
Case Style	C - 16		

(*) $\frac{dP_{tot}}{dT_j} < \frac{1}{R_{th(j-a)}}$ thermal runaway condition for a diode on its own heatsink

(**) Mounted 1 inch square PCB, thermal probe connected to lead 2mm from package

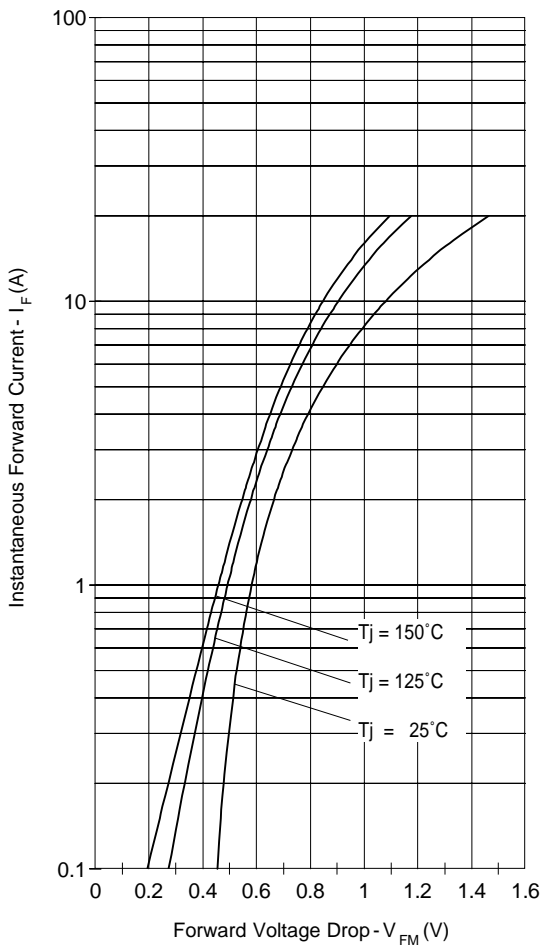

Fig.1 - Max. Forward Voltage Drop Characteristics

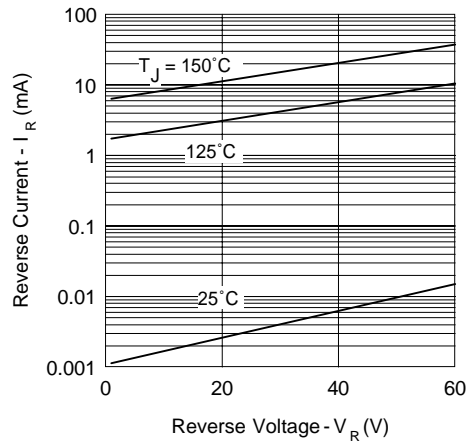

Fig.2 - Typical Values Of Reverse Current Vs. Reverse Voltage

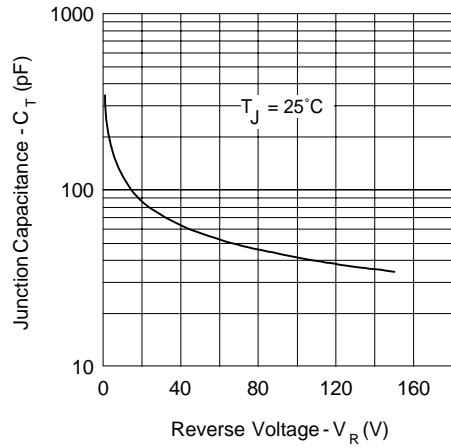

Fig.3 - Typical Junction Capacitance Vs. Reverse Voltage

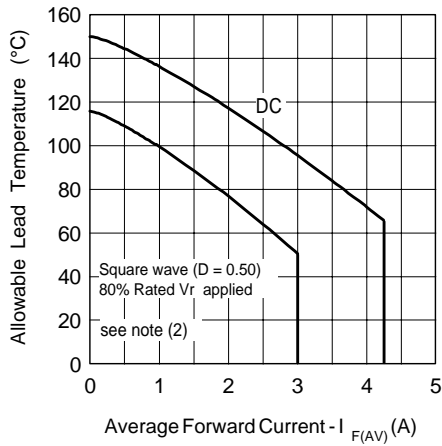

Fig. 4 - Max. Allowable Lead Temperature Vs. Average Forward Current

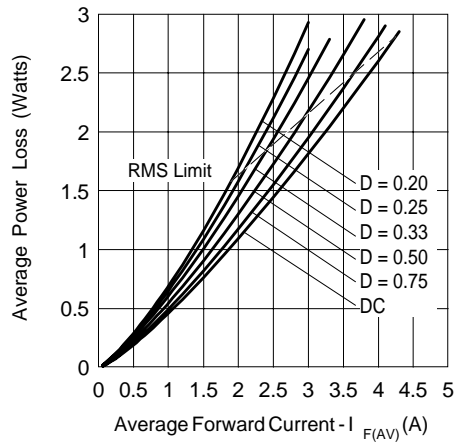

Fig. 5 - Forward Power Loss Characteristics

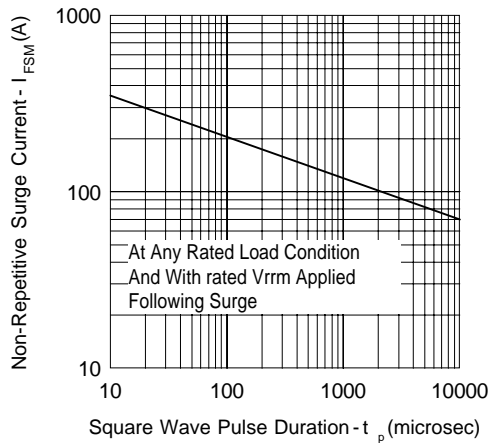
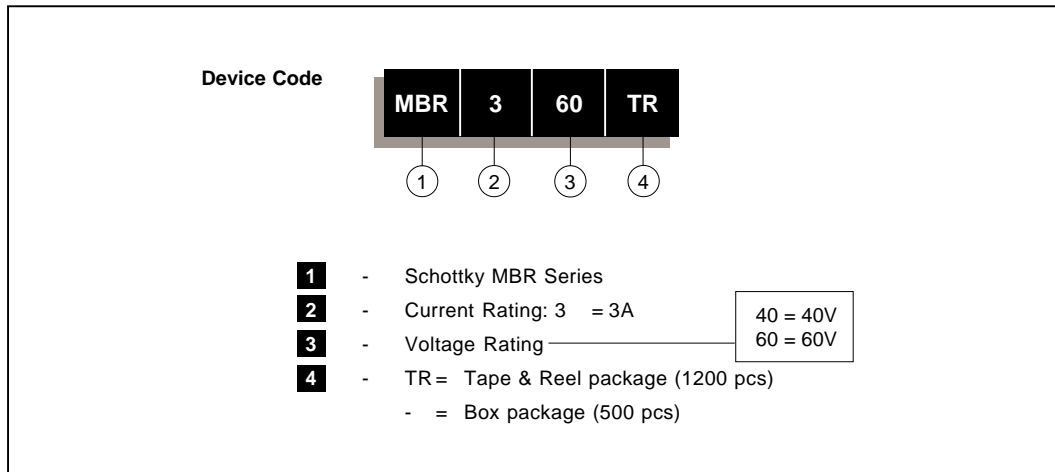

Fig. 6 - Max. Non-Repetitive Surge Current

(2) Formula used: $T_c = T_j - (Pd + Pd_{REV}) \times R_{thJC}$;
 $Pd = \text{Forward Power Loss} = I_{F(AV)} \times V_{FM} @ (I_{F(AV)} / D)$ (see Fig. 6);
 $Pd_{REV} = \text{Inverse Power Loss} = V_{R1} \times I_R (1 - D); I_R @ V_{R1} = 80\% \text{ rated } V_R$

Ordering Information Table



Data and specifications subject to change without notice.
 This product has been designed and qualified for Industrial Level.
 Qualification Standards can be found on IR's Web site.