

ASSP Mobile Communication Systems

Piezoelectric SAW BPF (1000 to 2500 MHz)

F6 Series (L2 type)

■ DESCRIPTION

The F6 series of SAW band pass filters apply to the frequency range 1000 to 2500 MHz.

The SAW filters are fabricated on a lithium tantalate (LiTaO_3) substrate, producing filters with a wide frequency bandwidth, low insertion loss in passband and superior stability due to the high electromechanical coupling coefficient of the material.

Fujitsu's leading techniques for making filter pattern designs realized this high frequency filter.

The F6 series filters are housed in a small surface mount package. Moreover, the impedance in the passband is 50Ω , and so applications require no external matching circuits.

The F6 series SAW filters are suitable for interstage RF filter in mobile communications systems in the sub microwave frequency band. Standard devices are available for PCS, DCS1800, and 2.4 GHz wireless LAN systems.

■ FEATURES

- High frequency filters
- Low insertion loss
- Ultra compact and light package (3.0 mm × 3.0 mm)
- External matching circuits are not required.
- Surface mount package (SMT)
- Wide variety of standard devices for worldwide mobile communication systems

■ PACKAGE

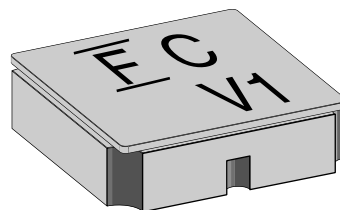

F6 Series (L2 type)

■ PIN ASSIGNMENT

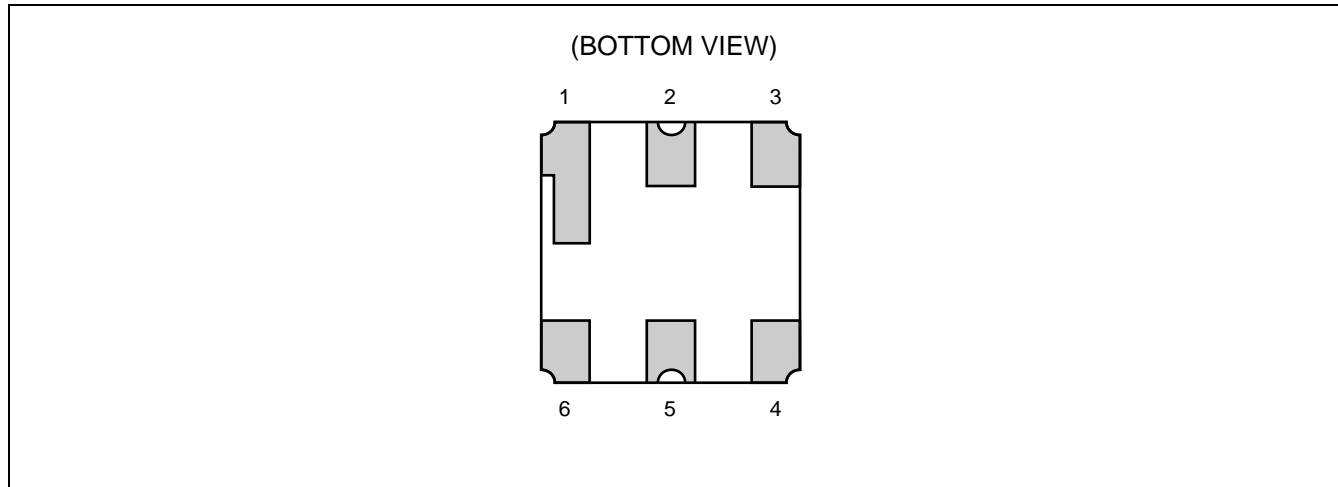

■ PIN DESCRIPTION

Pin No.	Pin name	Description
1	GND	Ground
2	IN	Input
3	GND	Ground
4	GND	Ground
5	OUT	Output
6	GND	Ground

■ ABSOLUTE MAXIMUM RATINGS

Parameter	Symbol	Value		Unit
		Min.	Max.	
Operating temperature	Ta	-30	+85	°C
Storage temperature	Tstg	-40	+100	°C
Maximum input level	P _{IN}	Refer to electrical characteristics		dBm
Input DC voltage	—	-5	+5	V

WARNING: Piezoelectric devices can be permanently damaged by application of stress (voltage, current, temperature, etc.) in excess of absolute maximum ratings. Do not exceed these ratings.

F6 Series (L2 type)

RECOMMENDED OPERATING CONDITIONS (See WARNING)

Parameter	Symbol	Value		Unit
		Min.	Max.	
Operating temperature *	Ta	-30	+85	°C

* : Standard Rating for Wireless LAN Systems is 0 to +60 °C.

WARNING: The recommended operating conditions are required in order to ensure the normal operation of the piezoelectric device. All of the device's electrical characteristics are warranted when the device is operated within these ranges.

Always use piezoelectric devices within their recommended operating condition ranges. Operation outside these ranges may adversely affect reliability and could result in device failure.

No warranty is made with respect to uses, operating conditions, or combinations not represented on the data sheet. Users considering application outside the listed conditions are advised to contact their FUJITSU representatives beforehand.

STANDARD FREQUENCIES

System		Center freq. (MHz)	Band width	Part symbol	Part number	Remarks
GPS		1575.42	2	6	FAR-F6CE-1G5754-L2UA	
PCN	Tx	1747.5	75	A	FAR-F6CE-1G7475-L2YA	
	Rx	1842.5	75	B	FAR-F6CE-1G8425-L2YB	
		1842.5	75	YE	FAR-F6CE-1G8425-L2YE	Low insertion loss type
US-PCS	Tx	1880.0	60	C	FAR-F6CE-1G8800-L2XA	
		1880.0	60	c	FAR-F6CE-1G8800-L2XZ	High Att. type
		1880.0	60	g	FAR-F6CE-1G8800-L2XJ	High Att. at Rx band
	Rx	1960.0	60	D	FAR-F6CE-1G9600-L2XB	
		1960.0	60	d	FAR-F6CE-1G9600-L2XY	High Att. type
		1960.0	60	v	FAR-F6CE-1G9600-L2XK	High Att. at Rx band
K-PCS	Tx	1765.0	30	S	FAR-F6CE-1G7650-L2TA	
	Rx	1855.0	30	T	FAR-F6CE-1G8550-L2TB	
Wireless LAN		2448.5	97	E	FAR-F6CE-2G4500-L2WA	
		2484.0	26	P	FAR-F6CE-2G4840-L2WC	For Japan
		2441.8	83	L	FAR-F6CE-2G4418-L2WD	For Europe, USA
W-CDMA	Tx	1950.0	60	j	FAR-F6CE-1G9500-L2ZP	
	Rx	2140.0	60	k	FAR-F6CE-2G1400-L2ZQ	
Bluetooth		2441.8	83.5	RB	FAR-F6CE-2G4418-L2RB	

F6 Series (L2 type)

■ ELECTRICAL CHARACTERISTICS (STANDARD VERSION)

1. GPS

Part number : FAR-F6CE-1G5754-L2UA

(Ta = -30 °C to +85 °C)

Parameter	Conditions	Value			Unit	Remarks
		Min.	Typ.	Max.		
Insertion loss	1574.42 to 1576.42 MHz	—	2.7	3.5	dB	
In-band deviation	1574.42 to 1576.42 MHz	—	0.2	1.0	dB	
Absolute stopband attenuation	1475.42 MHz	35	37	—	dB	
	1525.42 MHz	35	50	—	dB	
	1625.42 MHz	30	38	—	dB	
	1675.42 MHz	30	35	—	dB	
In-band VSWR (Return loss)	1574.42 to 1576.42 MHz	— (9.5)	1.4 (15.6)	2.0 —	— (dB)	
Max. input power	1574.42 to 1576.42 MHz	—	—	10	dBm	

2. PCN (Tx)

Part number : FAR-F6CE-1G7475-L2YA

(Ta = -30 °C to +85 °C)

Parameter	Conditions	Value			Unit	Remarks
		Min.	Typ.	Max.		
Insertion loss	1710 to 1785 MHz	—	3.0	4.2	dB	
In-band deviation	1710 to 1785 MHz	—	1.8	2.7	dB	
Absolute stopband attenuation	DC to 1500 MHz	17	19	—	dB	
	1500 to 1670 MHz	20	22	—	dB	
	1805 to 1880 MHz	7	12	—	dB	
	1880 to 2200 MHz	20	23	—	dB	
	3420 to 3570 MHz	25	31	—	dB	
	5130 to 5355 MHz	15	25	—	dB	
In-band VSWR (Return loss)	1710 to 1785 MHz	— (6.0)	2.5 (7.4)	3.0 —	— (dB)	
Max. input power	1710 to 1785 MHz	—	—	13	dBm	

F6 Series (L2 type)

3. PCN (Rx)

Part number : FAR-F6CE-1G8425-L2YB

(Ta = -30 °C to +85 °C)

Parameter	Conditions	Value			Unit	Remarks
		Min.	Typ.	Max.		
Insertion loss	1805 to 1880 MHz	—	3.3	4.5	dB	
In-band deviation	1805 to 1880 MHz	—	1.5	2.5	dB	
Absolute stopband attenuation	DC to 1500 MHz	20	22	—	dB	
	1600 to 1710 MHz	22	24	—	dB	
	1710 to 1785 MHz	10	29	—	dB	
	1920 to 2400 MHz	25	27	—	dB	
	3610 to 3760 MHz	25	35	—	dB	
	5415 to 5640 MHz	15	21	—	dB	
In-band VSWR (Return loss)	1805 to 1880 MHz	— (6.0)	2.5 (7.4)	3.0 —	— (dB)	
Max. input power	1805 to 1880 MHz	—	—	13	dBm	

4. PCN (Rx) Low insertion loss type

Part number : FAR-F6CE-1G8425-L2YE

(Ta = -30 °C to +85 °C)

Parameter	Conditions	Value			Unit	Remarks
		Min.	Typ.	Max.		
Insertion loss	1805 to 1880 MHz	—	2.6	3.7	dB	
In-band deviation	1805 to 1880 MHz	—	1.0	2.1	dB	
Absolute stopband attenuation	DC to 1720 MHz	15	17	—	dB	
	1720 to 1765 MHz	25	28	—	dB	
	1765 to 1785 MHz	8	20	—	dB	
	1920 to 1980 MHz	15	23	—	dB	
	1980 to 2400 MHz	17	21	—	dB	
	2400 to 3500 MHz	20	23	—	dB	
	3500 to 4000 MHz	15	24	—	dB	
	4000 to 6000 MHz	5	8	—	dB	
In-band VSWR (Return loss)	1805 to 1880 MHz	— (6.0)	2.6 (7.0)	3.0 —	— (dB)	
Max. input power	1805 to 1880 MHz	—	—	13	dBm	

F6 Series (L2 type)

5. US-PCS (Tx)

Part number : FAR-F6CE-1G8800-L2XA

(Ta = -30 °C to +85 °C)

Parameter	Conditions	Value			Unit	Remarks
		Min.	Typ.	Max.		
Insertion loss	1850 to 1910 MHz	—	3.2	4.2	dB	
In-band deviation	1850 to 1910 MHz	—	2.0	2.5	dB	
Absolute stopband attenuation	DC to 1500 MHz	20	22	—	dB	
	1500 to 1800 MHz	23	25	—	dB	
	1930 to 1990 MHz	7	18	—	dB	
	3700 to 3820 MHz	25	32	—	dB	
	5550 to 5730 MHz	15	21	—	dB	
In-band VSWR (Return loss)	1850 to 1910 MHz	— (7.4)	2.0 (9.5)	2.5 —	— (dB)	
Max. input power	1850 to 1910 MHz	—	—	13	dBm	

6. US-PCS (Tx) High Attenuation type

Part number : FAR-F6CE-1G8800-L2XZ

(Ta = -30 °C to +85 °C)

Parameter	Conditions	Value			Unit	Remarks
		Min.	Typ.	Max.		
Insertion loss	1850 to 1910 MHz	—	3.7	5.0	dB	
In-band deviation	1850 to 1910 MHz	—	1.7	3.0	dB	
Absolute stopband attenuation	DC to 120 MHz	40	47	—	dB	
	120 to 200 MHz	38	42	—	dB	
	200 to 1500 MHz	32	34	—	dB	
	1500 to 1800 MHz	35	38	—	dB	
	1930 to 1990 MHz	7	17	—	dB	
	1990 to 2200 MHz	35	41	—	dB	
	2200 to 2350 MHz	40	43	—	dB	
	2350 to 4000 MHz	20	32	—	dB	
	4000 to 5000 MHz	5	9	—	dB	
In-band VSWR (Return loss)	1850 to 1910 MHz	— (6.5)	2.3 (8.1)	2.8 —	— (dB)	
Max. input power	1850 to 1910 MHz	—	—	13	dBm	

F6 Series (L2 type)

7. US-PCS (Tx) High Attenuation at Rx band type

Part number : FAR-F6CE-1G8800-L2XJ

(Ta = -30 °C to +85 °C)

Parameter	Conditions	Value			Unit	Remarks
		Min.	Typ.	Max.		
Insertion loss	1850 to 1910 MHz	—	2.7	4.2	dB	
In-band deviation	1850 to 1910 MHz	—	1.2	2.6	dB	
Absolute stopband attenuation	DC to 1500 MHz	15	20	—	dB	
	1500 to 1750 MHz	20	22	—	dB	
	1930 to 1990 MHz	9	15	—	dB	
	1990 to 2300 MHz	20	25	—	dB	
	2300 to 2500 MHz	15	20	—	dB	
In-band VSWR (Return loss)	1850 to 1910 MHz	— (7.4)	2.2 (8.5)	2.5 —	— (dB)	
Max. input power	1850 to 1910 MHz	—	—	13	dBm	

8. US-PCS (Rx)

Part number : FAR-F6CE-1G9600-L2XB

(Ta = -30 °C to +85 °C)

Parameter	Conditions	Value			Unit	Remarks
		Min.	Typ.	Max.		
Insertion loss	1930 to 1990 MHz	—	3.3	4.5	dB	
In-band deviation	1930 to 1990 MHz	—	2.0	2.8	dB	
Absolute stopband attenuation	DC to 1500 MHz	21	23	—	dB	
	1500 to 1850 MHz	23	25	—	dB	
	1850 to 1910 MHz	10	30	—	dB	
	3860 to 3980 MHz	25	32	—	dB	
	5790 to 5970 MHz	15	23	—	dB	
In-band VSWR (Return loss)	1930 to 1990 MHz	— (7.4)	1.8 (10.9)	2.5 —	— (dB)	
Max. input power	1930 to 1990 MHz	—	—	13	dBm	

F6 Series (L2 type)

9. US-PCS (Rx) High Attenuation type Part number : FAR-F6CE-1G9600-L2XY

(Ta = -30 °C to +85 °C)

Parameter	Conditions	Value			Unit	Remarks
		Min.	Typ.	Max.		
Insertion loss	1930 to 1990 MHz	—	3.5	5.0	dB	
In-band deviation	1930 to 1990 MHz	—	1.0	2.5	dB	
Absolute stopband attenuation	DC to 100 MHz	40	42	—	dB	
	100 to 200 MHz	35	36	—	dB	
	200 to 1100 MHz	25	30	—	dB	
	1100 to 1190 MHz	29	31	—	dB	
	1190 to 1700 MHz	30	32	—	dB	
	1700 to 1850 MHz	35	41	—	dB	
	1850 to 1880 MHz	25	47	—	dB	
	1880 to 1910 MHz	8	12	—	dB	
	2010 to 2040 MHz	8	15	—	dB	
	2040 to 2070 MHz	25	48	—	dB	
	2070 to 2300 MHz	40	41	—	dB	
	2300 to 3100 MHz	35	37	—	dB	
	3100 to 3700 MHz	33	36	—	dB	
	3700 to 4800 MHz	25	35	—	dB	
4800 to 6000 MHz	10	14	—	dB		
In-band VSWR (Return loss)	1930 to 1990 MHz	— (7.0)	2.3 (8.1)	2.6 —	— (dB)	
Max. input power	1930 to 1990 MHz	—	—	13	dBm	

F6 Series (L2 type)

10. US-PCS (Rx) Low insertion loss type Part number : FAR-F6CE-1G9600-L2XK

(Ta = -30 °C to +85 °C)

Parameter	Conditions	Value			Unit	Remarks
		Min.	Typ.	Max.		
Insertion loss	1930 to 1990 MHz	—	3.2	4.5	dB	Ta = -30 °C to -15 °C
				4.2		Ta = -15 °C to +85 °C
In-band deviation	1930 to 1990 MHz	—	1.7	3.0	dB	
Absolute stopband attenuation	DC to 1500 MHz	18	21	—	dB	
	1500 to 1850 MHz	20	25	—	dB	
	1850 to 1910 MHz	15	21	—	dB	Ta = -30 °C to +65 °C
		13			dB	Ta = +65 °C to +85 °C
	2010 to 2020 MHz	4	9	—	dB	
	2020 to 2040 MHz	10	21	—	dB	
	2040 to 2295 MHz	20	29	—	dB	
	2295 to 2500 MHz	30	31	—	dB	
	2500 to 4000 MHz	10	16	—	dB	
4000 to 6000 MHz	4	6	—	dB		
In-band VSWR (Return loss)	1930 to 1990 MHz	— (8.1)	1.7 (11.7)	2.3 —	— (dB)	
Max. input power	1930 to 1990 MHz	—	—	13	dBm	

11. Korea-PCS (Tx) Upper 30 MHz Band Width Part number : FAR-F6CE-1G7650-L2TA

(Ta = -30 °C to +85 °C)

Parameter	Conditions	Value			Unit	Remarks
		Min.	Typ.	Max.		
Insertion loss	1750 to 1780 MHz	—	2.2	2.5	dB	Ta = +25 °C
				3.0		Ta = -30 °C to +85 °C
In-band deviation	1750 to 1780 MHz	—	1.2	1.5	dB	
Absolute stopband attenuation	1350 to 1380 MHz	25	27	—	dB	
	1660 to 1690 MHz	30	40	—	dB	
	1840 to 1870 MHz	30	35	—	dB	
	2150 to 2180 MHz	30	33	—	dB	
In-band VSWR (Return loss)	1750 to 1780 MHz	— (9.5)	1.8 (10.9)	2.0 —	— (dB)	
Max. input power	1750 to 1780 MHz	—	—	13	dBm	

F6 Series (L2 type)

12. Korea-PCS (Rx) Upper 30 MHz Band Width Part number : FAR-F6CE-1G8550-L2TB

(Ta = -30 °C to +85 °C)

Parameter	Conditions	Value			Unit	Remarks
		Min.	Typ.	Max.		
Insertion loss	1840 to 1870 MHz	—	2.2	2.5	dB	Ta = +25 °C
				3.0		Ta = -30 °C to +85 °C
In-band deviation	1840 to 1870 MHz	—	1.1	1.5	dB	
Absolute stopband attenuation	1440 to 1470 MHz	25	28	—	dB	
	1750 to 1780 MHz	30	40	—	dB	
	1930 to 1960 MHz	30	40	—	dB	
	2240 to 2270 MHz	30	34	—	dB	
In-band VSWR (Return loss)	1840 to 1870 MHz	— (9.5)	1.7 (11.7)	2.0 —	— (dB)	
Max. input power	1840 to 1870 MHz	—	—	13	dBm	

13. Wireless-LAN 97 MHz Band Width Part number : FAR-F6CE-2G4500-L2WA

(Ta = 0 to +60 °C)

Parameter	Conditions	Value			Unit	Remarks
		Min.	Typ.	Max.		
Insertion loss	2400 to 2497 MHz	—	4.0	5.0	dB	
In-band deviation	2400 to 2497 MHz	—	2.0	3.0	dB	
Absolute stopband attenuation	DC to 1700 MHz	20	22	—	dB	
	1800 to 2200 MHz	25	27	—	dB	
	2700 to 3100 MHz	30	33	—	dB	
	4800 to 5000 MHz	10	16	—	dB	
In-band VSWR (Return loss)	2400 to 2497 MHz	— (7.0)	2.2 (8.5)	2.6 —	— (dB)	
Max. input power	2400 to 2497 MHz	—	—	10	dBm	

F6 Series (L2 type)

14. Wireless-LAN 26 MHz Band Width (For Japan)

Part number : FAR-F6CE-2G4840-L2WC

(Ta = 0 to +60 °C)

Parameter	Conditions	Value			Unit	Remarks
		Min.	Typ.	Max.		
Insertion loss	2471 to 2497 MHz	—	2.5	3.5	dB	
In-band deviation	2471 to 2497 MHz	—	1.0	1.5	dB	
Absolute stopband attenuation	DC to 1700 MHz	20	23	—	dB	
	1800 to 2200 MHz	25	27	—	dB	
	2700 to 3100 MHz	30	33	—	dB	
	4800 to 5000 MHz	10	16	—	dB	
In-band VSWR (Return loss)	2471 to 2497 MHz	— (9.5)	1.5 (14.0)	2.0 —	— (dB)	
Max. input power	2471 to 2497 MHz	—	—	10	dBm	

15. Wireless-LAN 83.5 MHz Band Width (For Europe, USA)

Part number : FAR-F6CE-2G4418-L2WD

(Ta = 0 to +60 °C)

Parameter	Conditions	Value			Unit	Remarks
		Min.	Typ.	Max.		
Insertion loss	2400 to 2483.5 MHz	—	3.2	4.5	dB	
In-band deviation	2400 to 2483.5 MHz	—	1.3	2.5	dB	
Absolute stopband attenuation	DC to 1700 MHz	20	22	—	dB	
	1800 to 2200 MHz	25	27	—	dB	
	2700 to 3100 MHz	30	33	—	dB	
	4800 to 5000 MHz	10	16	—	dB	
In-band VSWR (Return loss)	2400 to 2483.5 MHz	— (7.0)	2.2 (8.5)	2.6 —	— (dB)	
Max. input power	2400 to 2483.5 MHz	—	—	10	dBm	

F6 Series (L2 type)

16. W-CDMA (Tx)

Part number : FAR-F6CE-1G9500-L2ZP

(Ta = -30 °C to +85 °C)

Parameter	Conditions	Value			Unit	Remarks
		Min.	Typ.	Max.		
Insertion loss	1920 to 1980 MHz	—	3.2	4.0	dB	
In-band deviation	1920 to 1980 MHz	—	1.2	2.0	dB	
Absolute stopband attenuation	DC to 1600 MHz	20	21	—	dB	
	1600 to 1800 MHz	23	25	—	dB	
	1800 to 1875 MHz	25	31	—	dB	
	2025 to 2050 MHz	30	31	—	dB	
	2050 to 3500 MHz	25	26	—	dB	
	3500 to 4000 MHz	20	30	—	dB	
In-band VSWR (Return loss)	1920 to 1980 MHz	—	2.0	2.2	—	
		(8.5)	(9.5)	—	(dB)	
Max. input power	1920 to 1980 MHz	—	—	13	dBm	

17. W-CDMA (Rx)

Part number : FAR-F6CE-2G1400-L2ZQ

(Ta = -30 °C to +85 °C)

Parameter	Conditions	Value			Unit	Remarks
		Min.	Typ.	Max.		
Insertion loss	2110 to 2170 MHz	—	3.2	4.0	dB	
In-band deviation	2110 to 2170 MHz	—	1.2	2.0	dB	
Absolute stopband attenuation	DC to 500 MHz	21	23	—	dB	
	500 to 1900 MHz	20	21	—	dB	
	1900 to 2050 MHz	25	28	—	dB	
	2215 to 2300 MHz	20	30	—	dB	
	2300 to 4500 MHz	25	27	—	dB	
In-band VSWR (Return loss)	2110 to 2170 MHz	—	2.0	2.2	—	
		(8.5)	(9.5)	—	(dB)	
Max. input power	2110 to 2170 MHz	—	—	13	dBm	

F6 Series (L2 type)

18. Bluetooth

Part number : FAR-F6CE-2G4418-L2RB

(Ta = 0 to +60 °C)

Parameter	Conditions	Value			Unit	Remarks
		Min.	Typ.	Max.		
Insertion loss	2400 to 2483.5 MHz	—	3.2	5.0	dB	
In-band deviation	2400 to 2483.5 MHz	—	1.2	3.0	dB	
Absolute stopband attenuation	DC to 1700 MHz	20	22	—	dB	
	1700 to 2200 MHz	25	27	—	dB	
	2700 to 3100 MHz	30	33	—	dB	
	3100 to 4000 MHz	20	27	—	dB	
	4000 to 5000 MHz	10	16	—	dB	
In-band VSWR (Return loss)	2400 to 2483.5 MHz	— (7.0)	2.2 (8.5)	2.6 —	— (dB)	
Max. input power	2400 to 2483.5 MHz	—	—	10	dBm	

F6 Series (L2 type)

■ TYPICAL CHARACTERISTICS (STANDARD VERSION)

1. GPS

Part number : FAR-F6CE-1G5754-L2UA

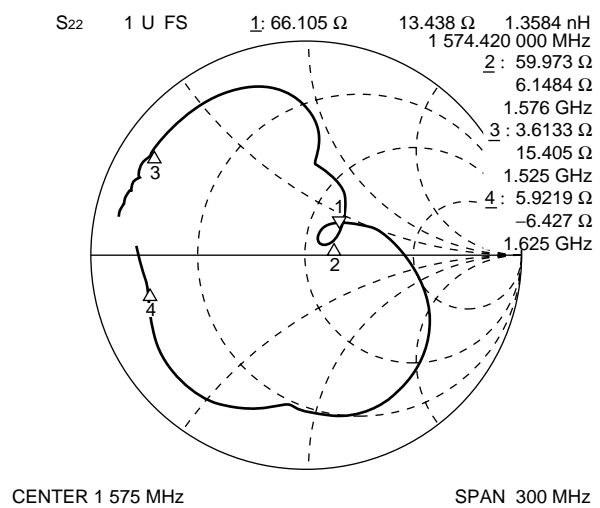
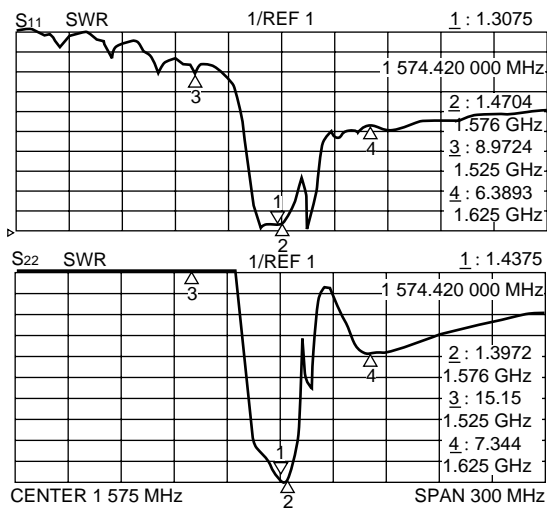
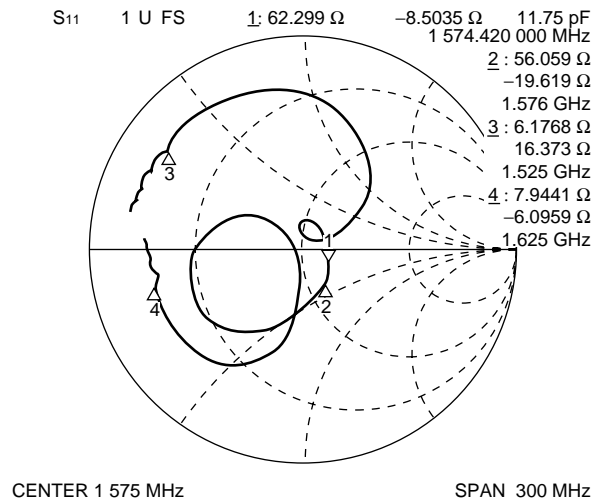
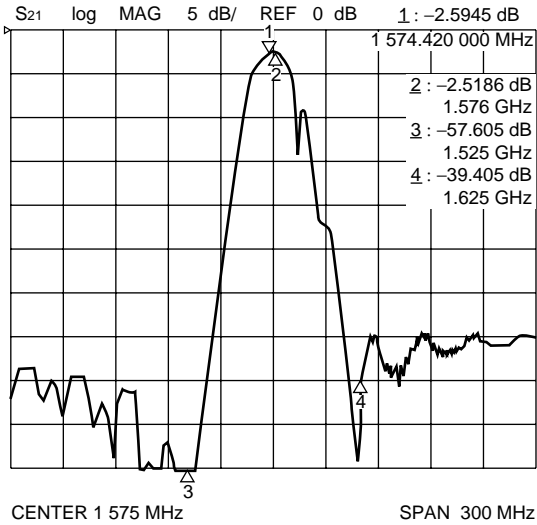

F6 Series (L2 type)

2. PCN (Tx)

Part number : FAR-F6CE-1G7475-L2YA

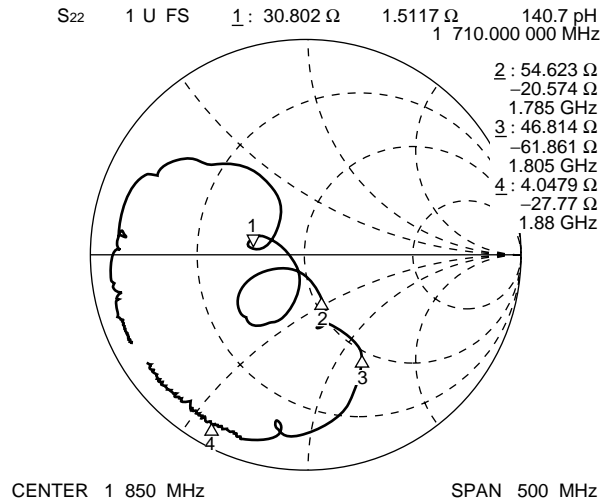
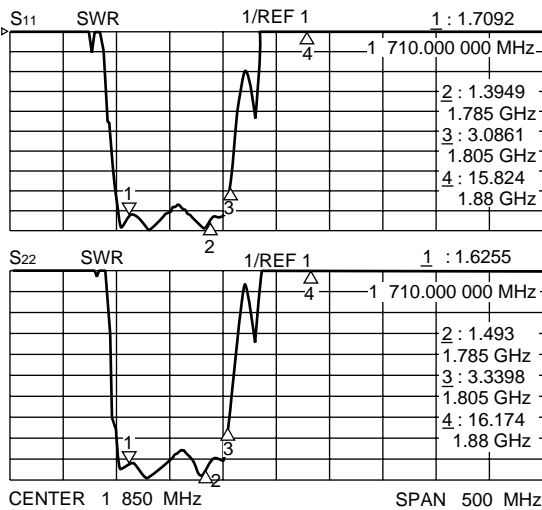
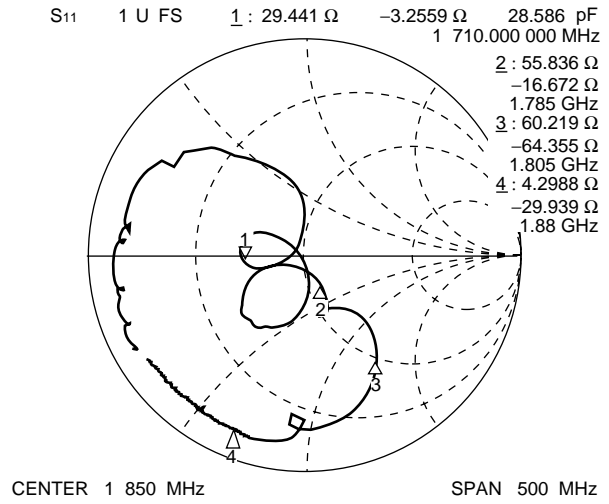
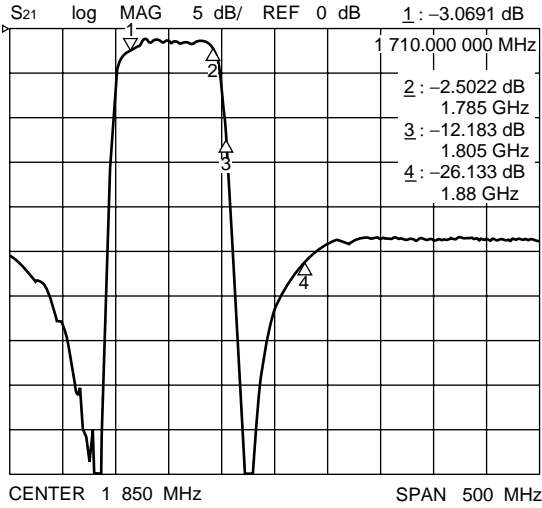

F6 Series (L2 type)

3. PCN (Rx)

Part number : FAR-F6CE-1G8425-L2YB

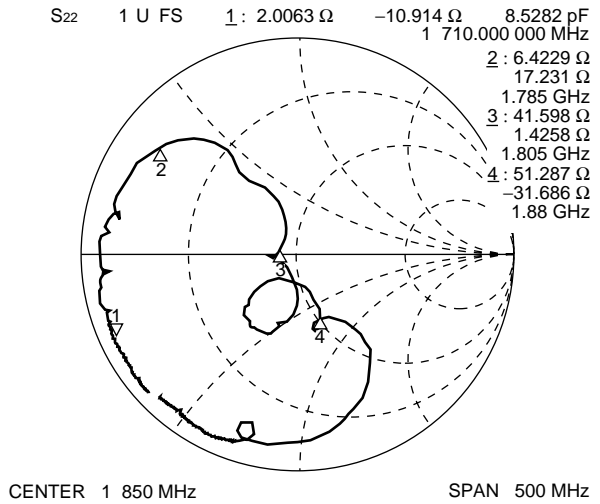
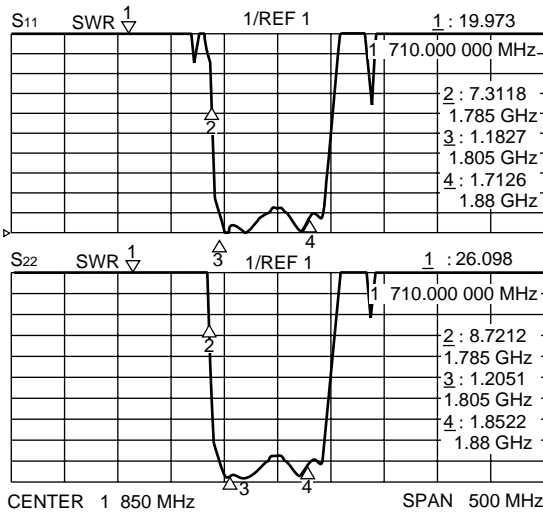
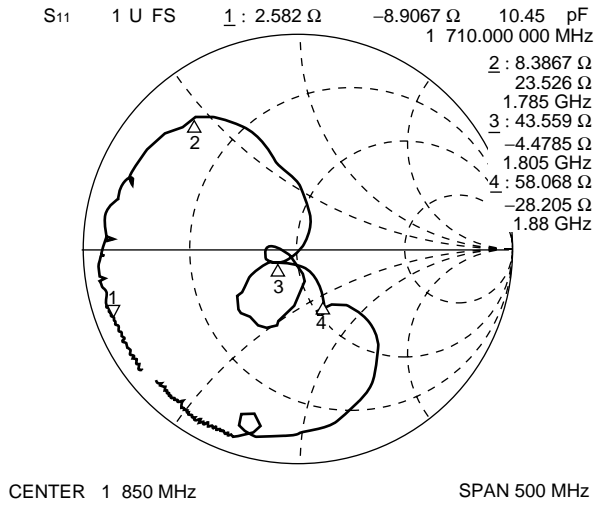
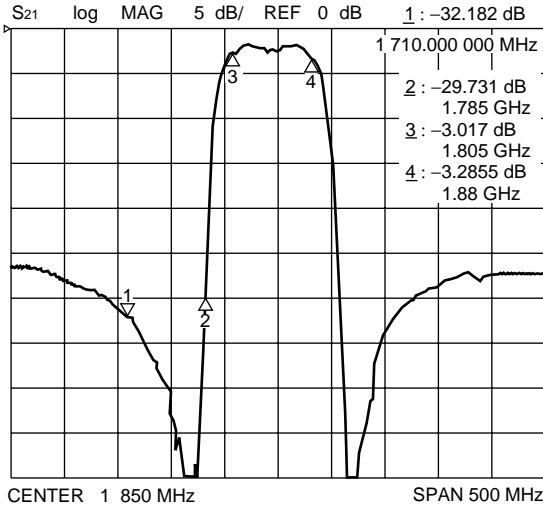

F6 Series (L2 type)

4. PCN (Rx) Low insertion loss type Part number : FAR-F6CE-1G8425-L2YE

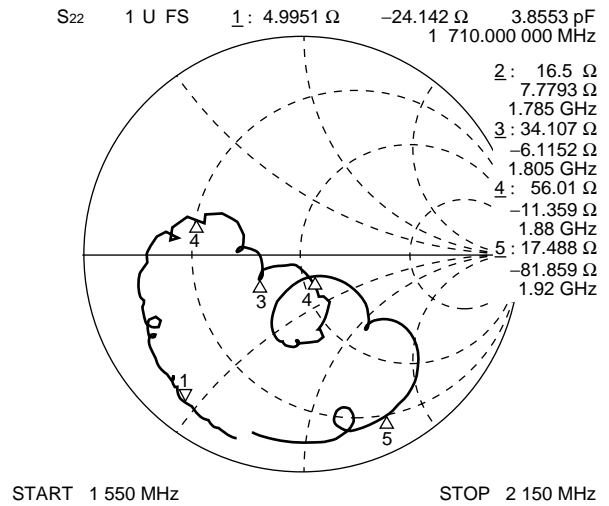
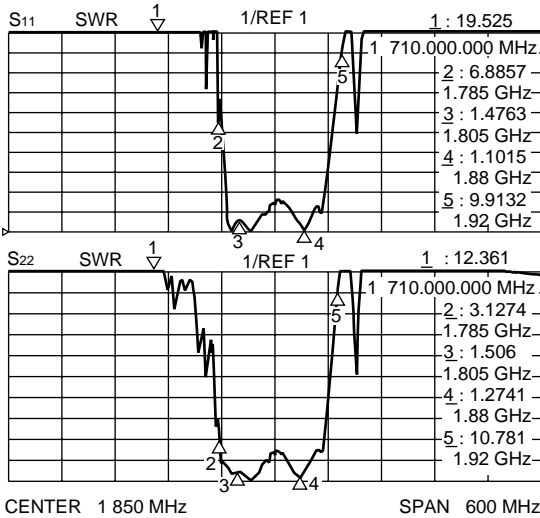
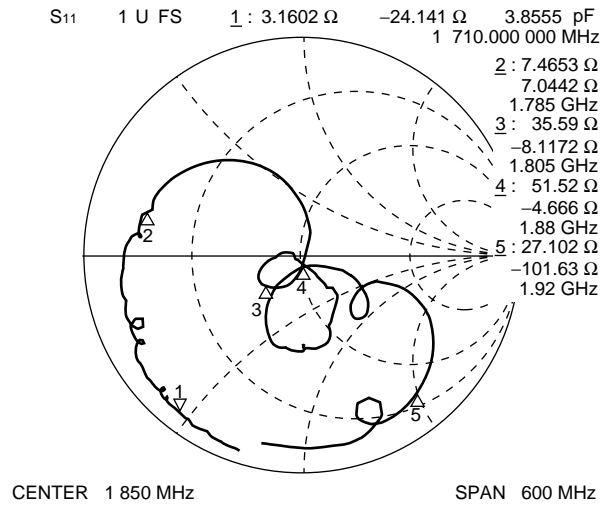
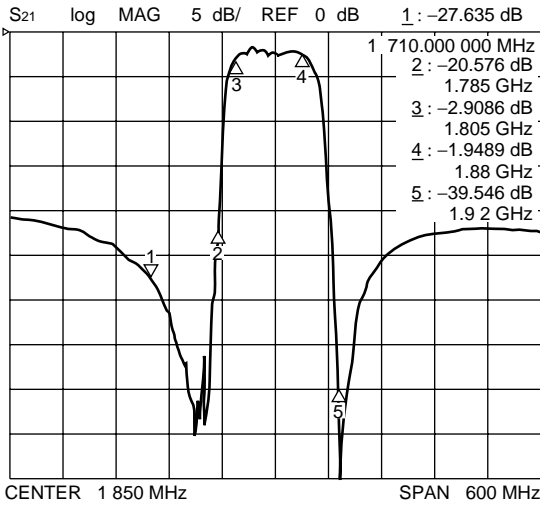

F6 Series (L2 type)

5. US-PCS (Tx)

Part number : FAR-F6CE-1G8800-L2XA

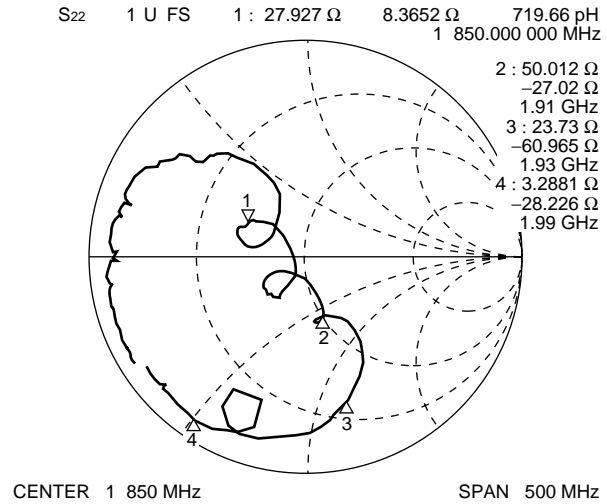
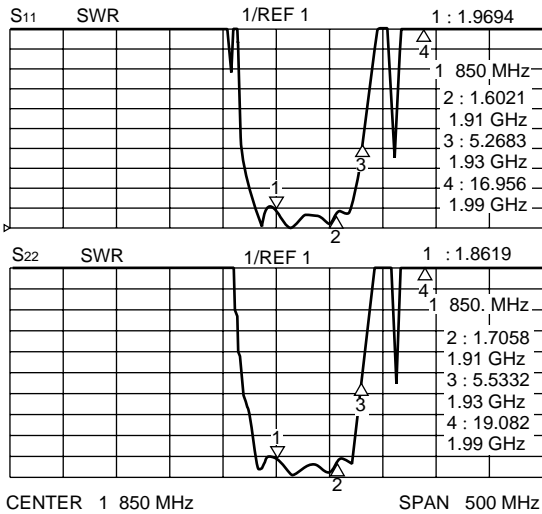
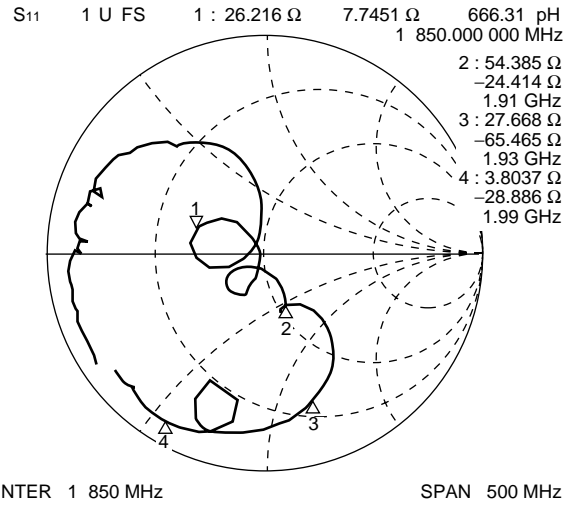
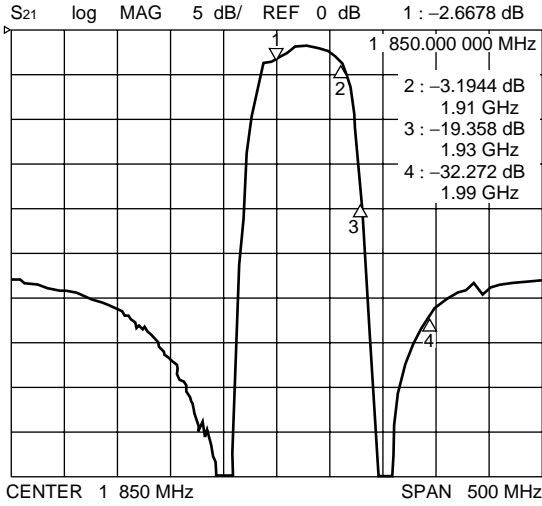

F6 Series (L2 type)

6. US-PCS (Tx) High Attenuation type Part number : FAR-F6CE-1G8800-L2XZ

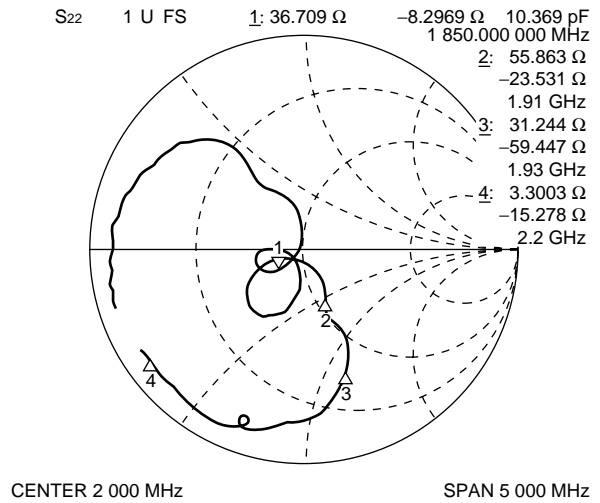
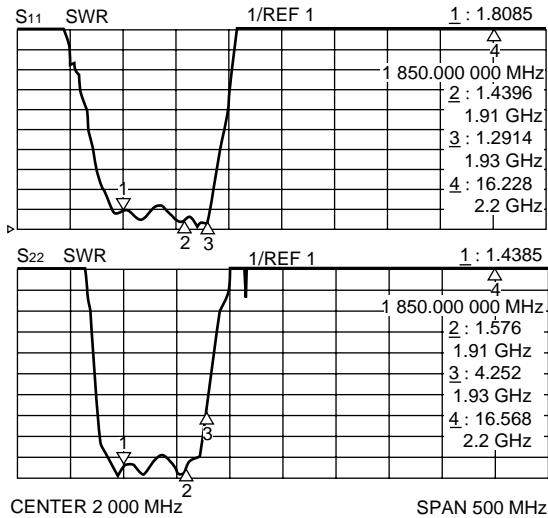
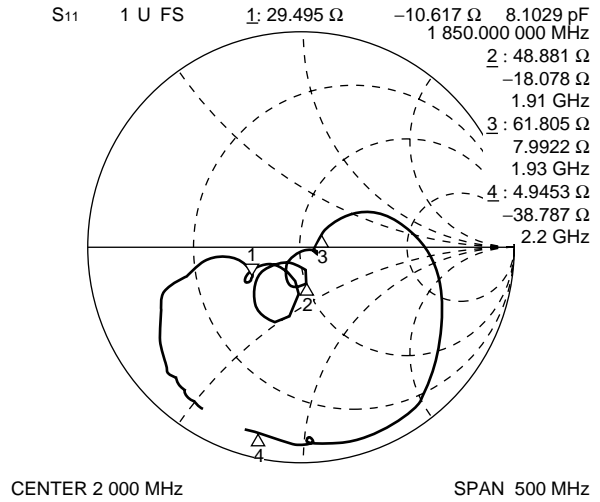
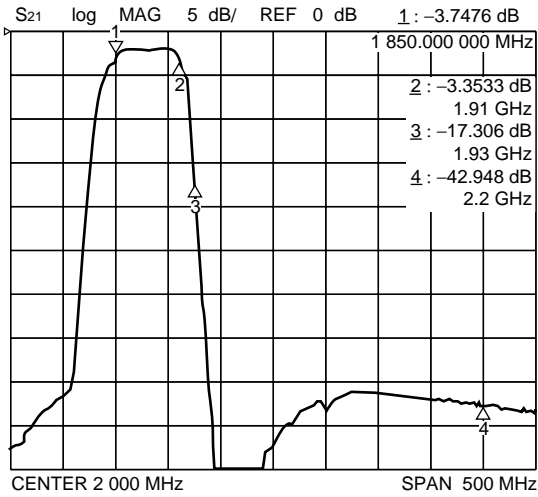

F6 Series (L2 type)

7. US-PCS (Tx) High Attenuation at Rx band type Part number : FAR-F6CE-1G8800-L2XJ

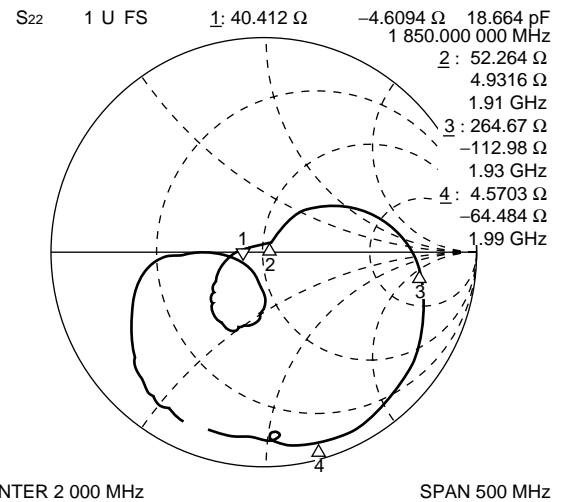
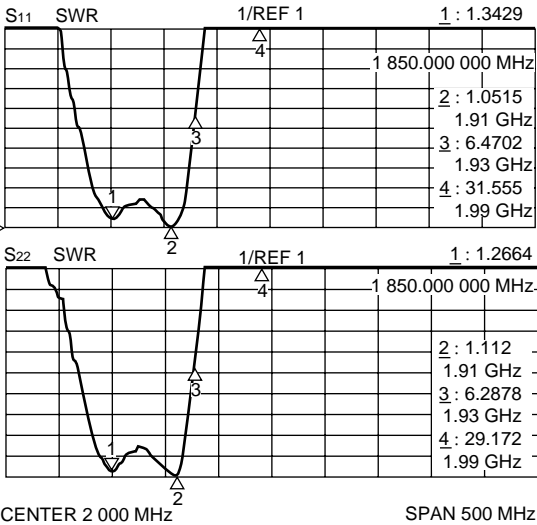
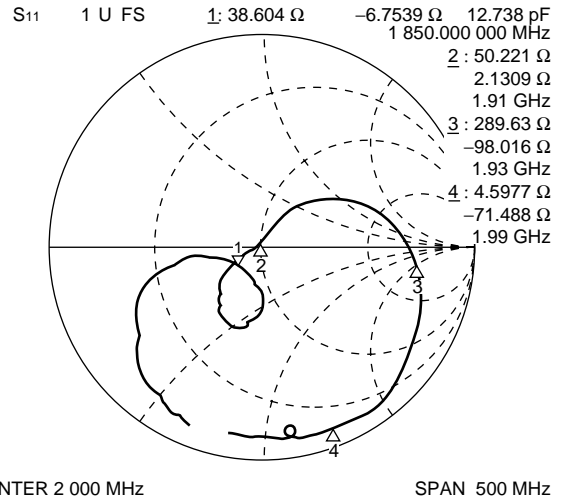
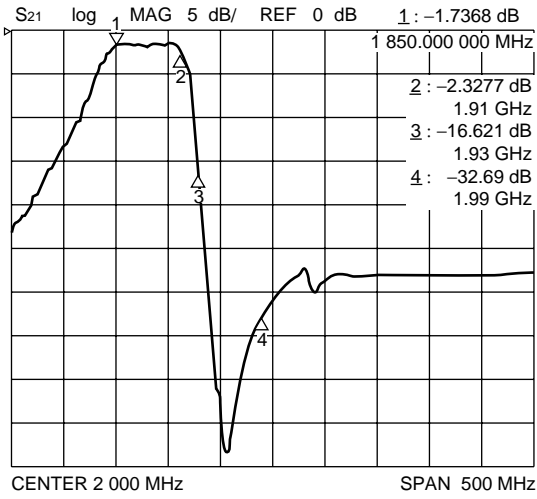

F6 Series (L2 type)

8. US-PCS (Rx)

Part number : FAR-F6CE-1G9600-L2XB

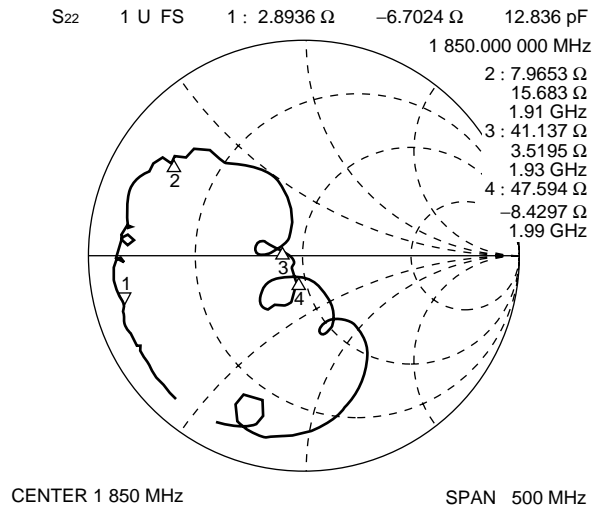
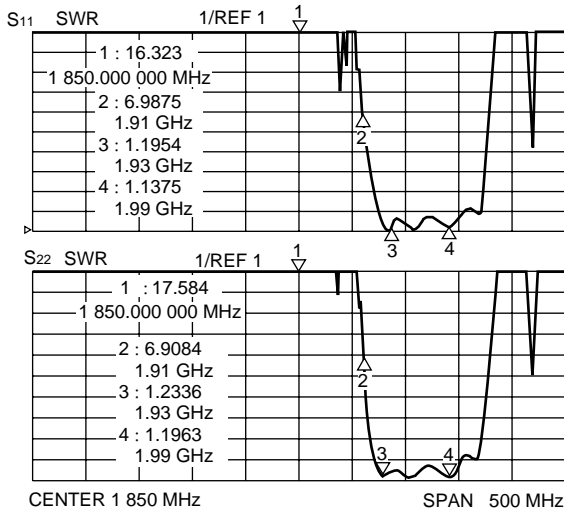
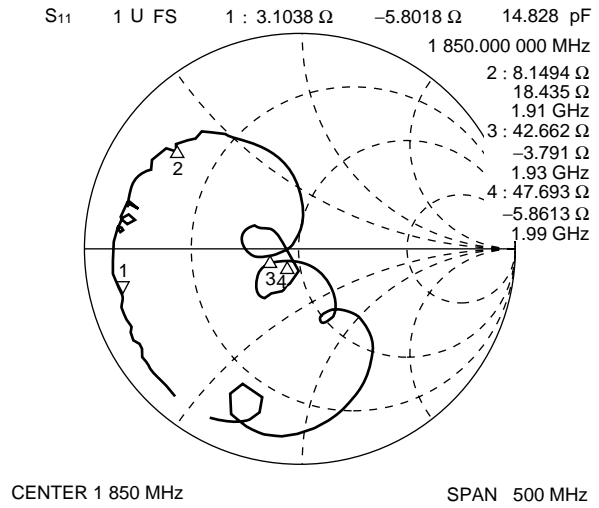
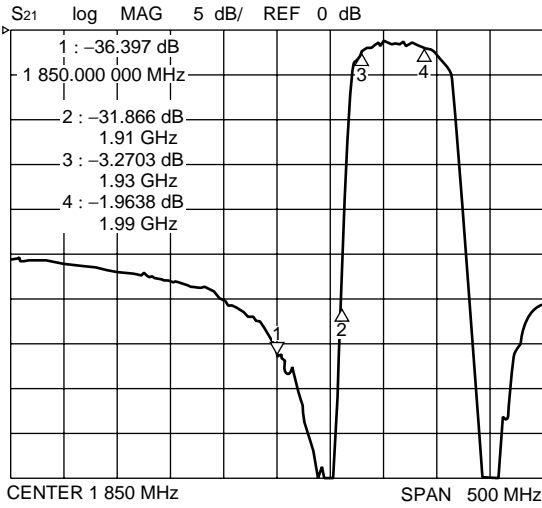

F6 Series (L2 type)

9. US-PCS (Rx) High Attenuation type Part number : FAR-F6CE-1G9600-L2XY

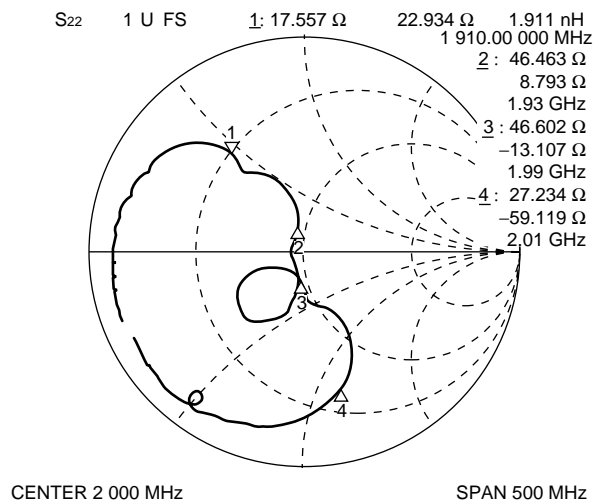
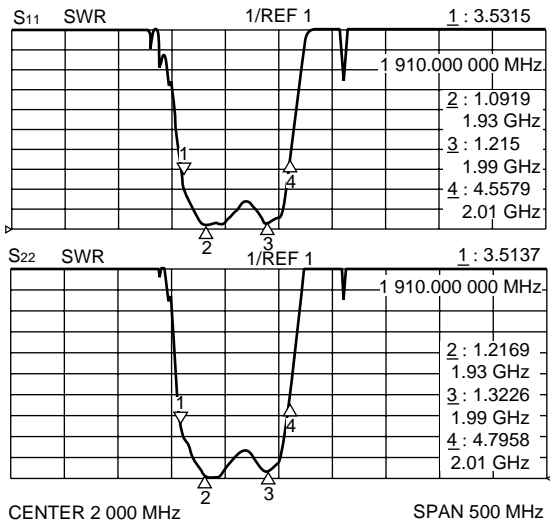
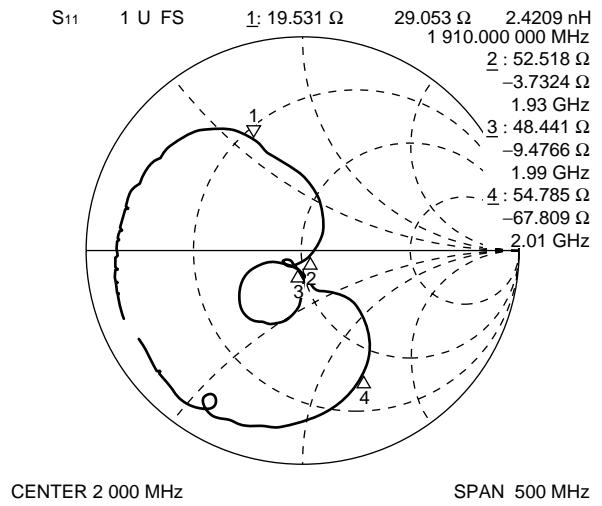
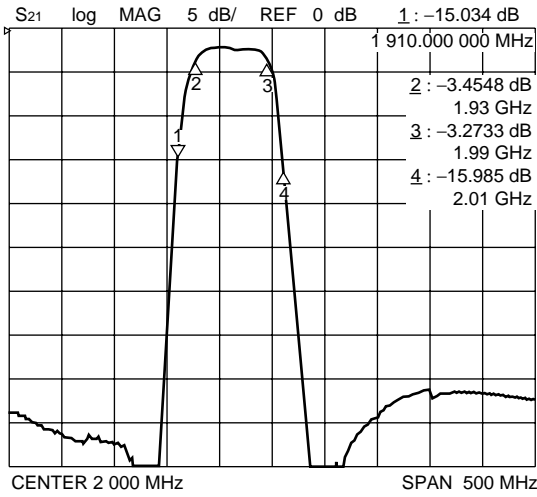

F6 Series (L2 type)

10. US-PCS (Rx) Low insertion loss type Part number : FAR-F6CE-1G9600-L2XK

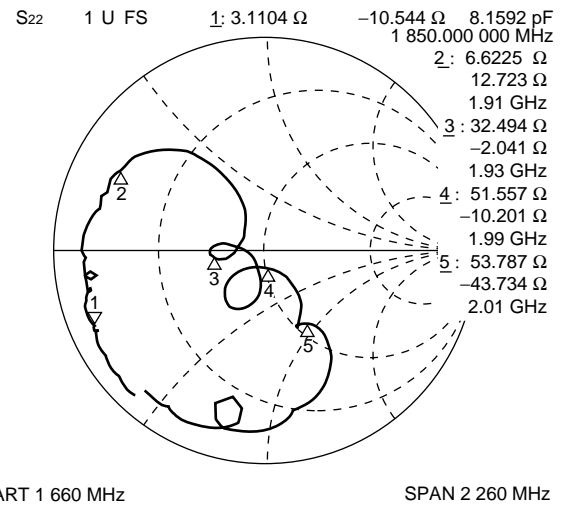
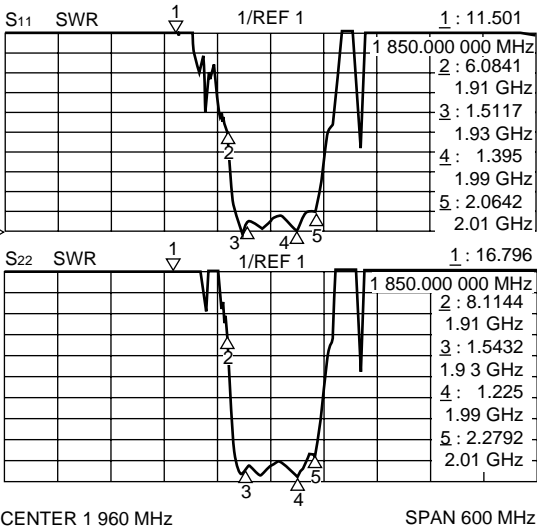
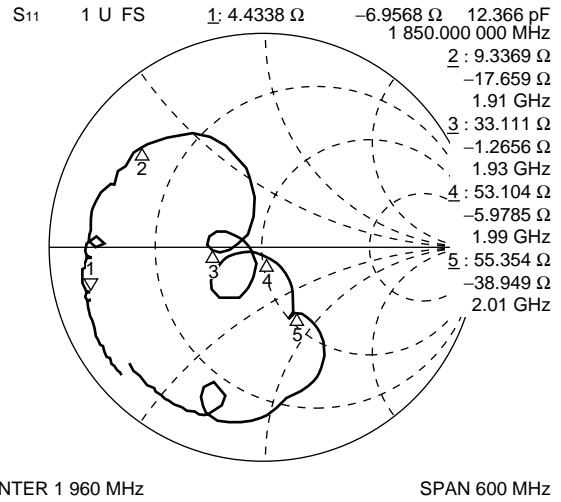
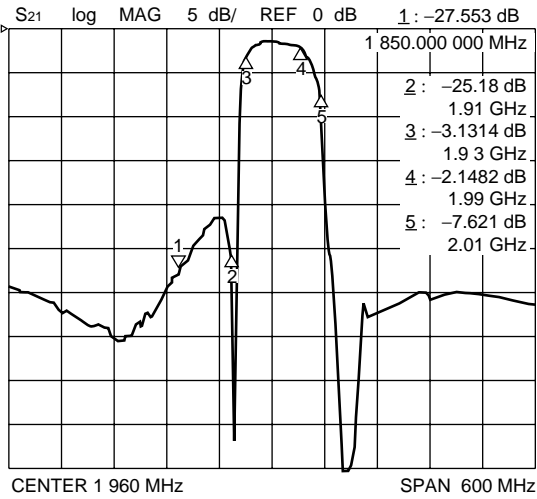

F6 Series (L2 type)

11. Korea-PCS (Tx) type

Part number : FAR-F6CE-1G7650-L2TA

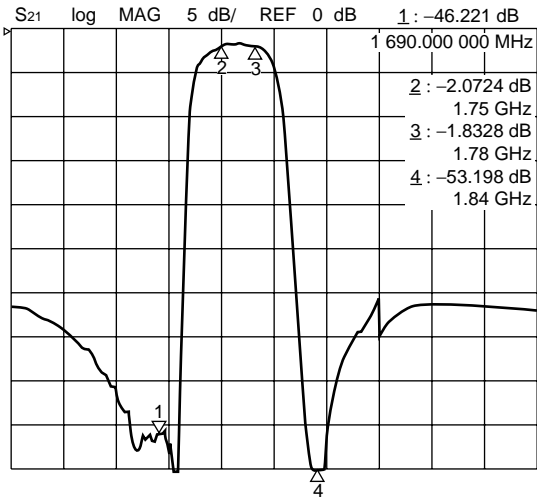

CENTER 1 800 MHz

SPAN 500 MHz

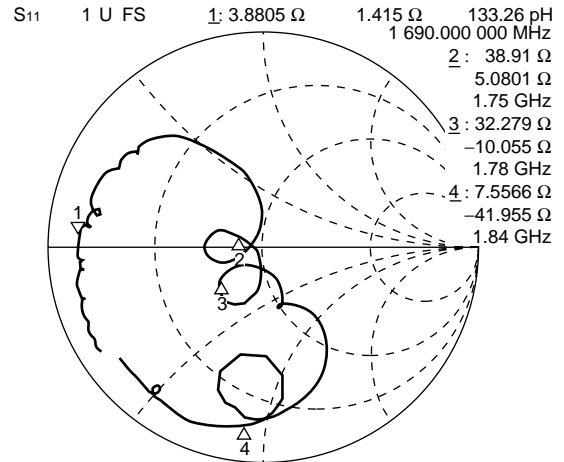

CENTER 1 800 MHz

SPAN 500 MHz

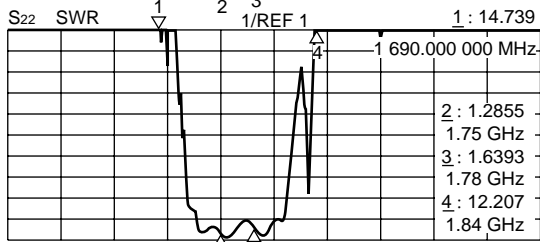
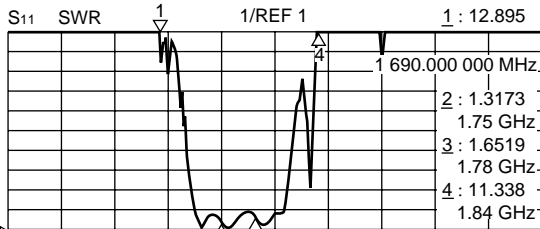

CENTER 1 800 MHz

SPAN 500 MHz

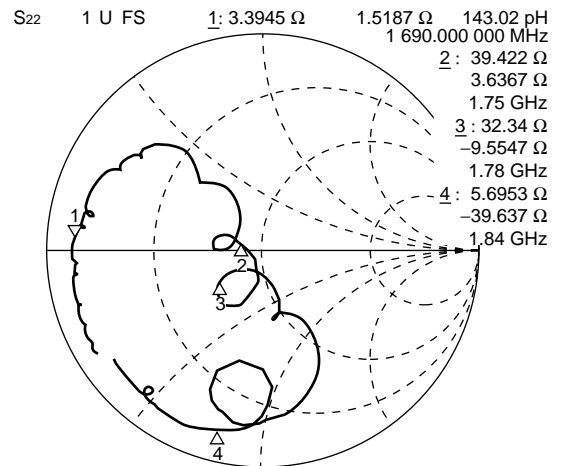

CENTER 1 800 MHz

SPAN 500 MHz

F6 Series (L2 type)

12. Korea-PCS (Rx)

Part number : FAR-F6CE-1G8550-L2TB

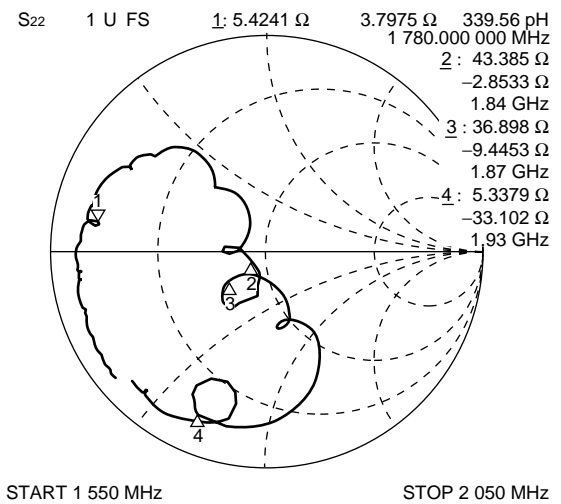
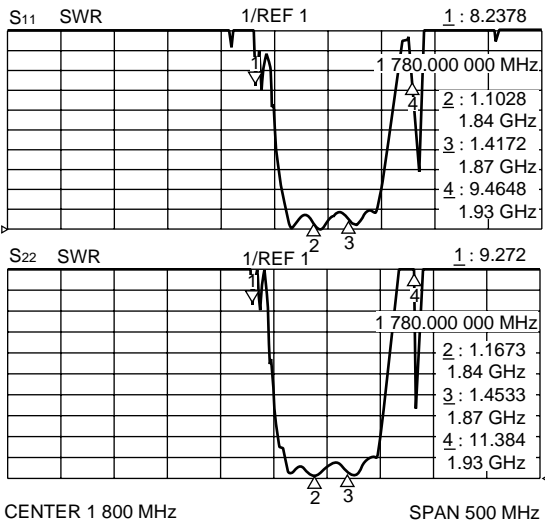
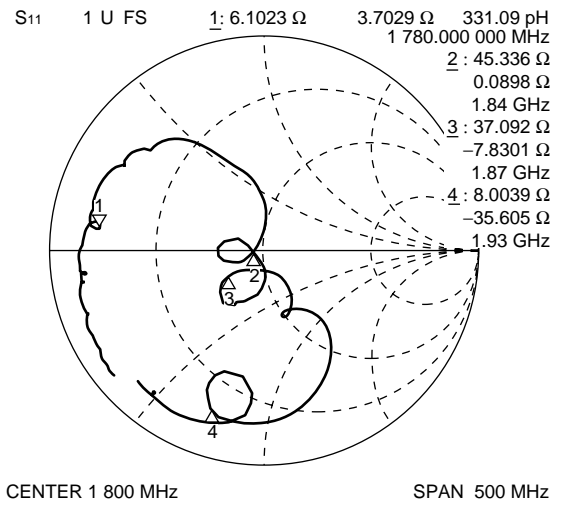
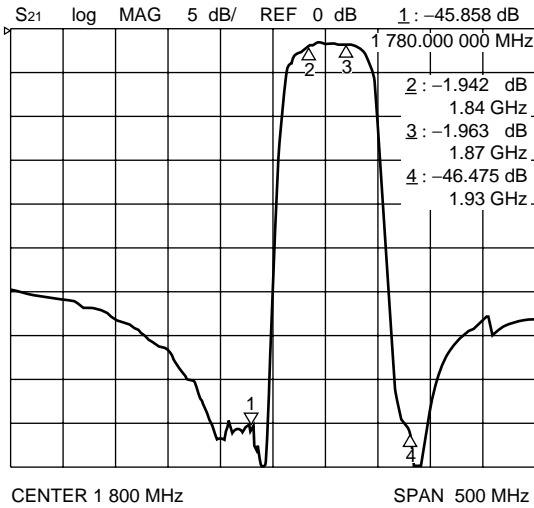

F6 Series (L2 type)

13. Wireless-LAN 97 MHz Band Width

Part number : FAR-F6CE-2G4500-L2WA

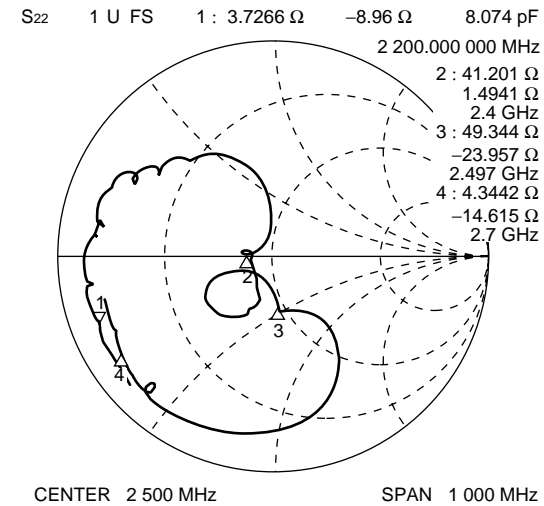
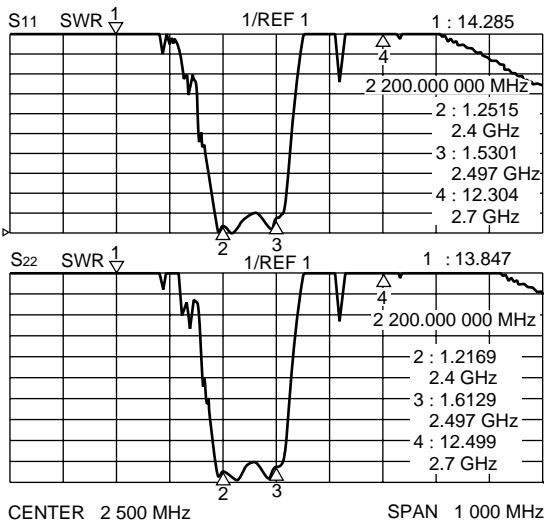
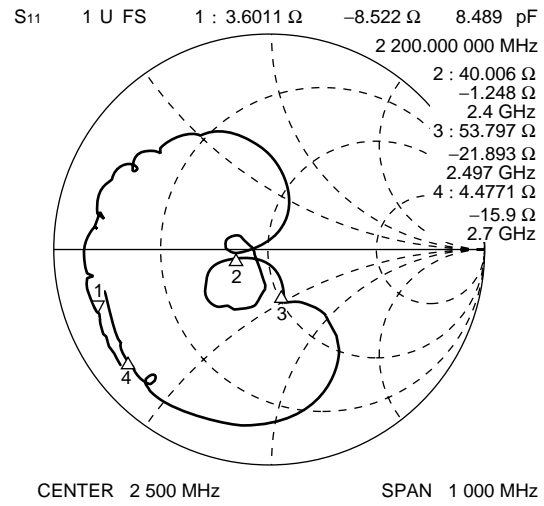
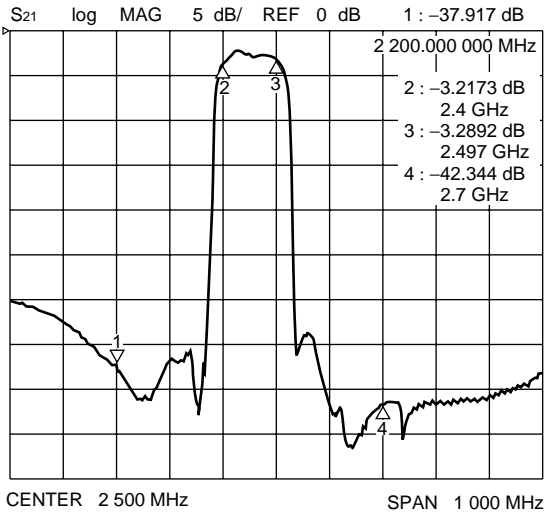

F6 Series (L2 type)

14. Wireless-LAN 26 MHz Band Width (For Japan) Part number : FAR-F6CE-2G4840-L2WC

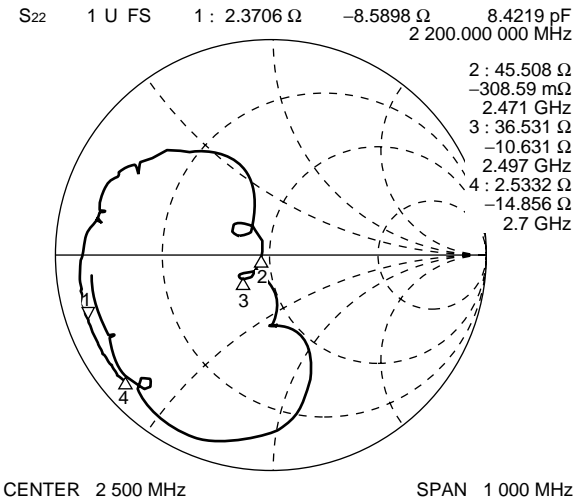
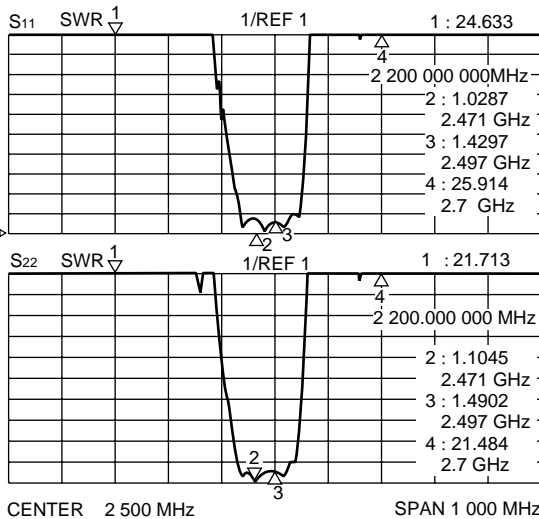
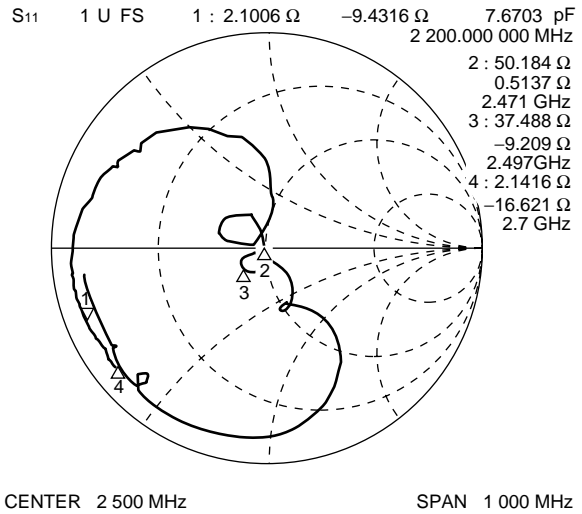
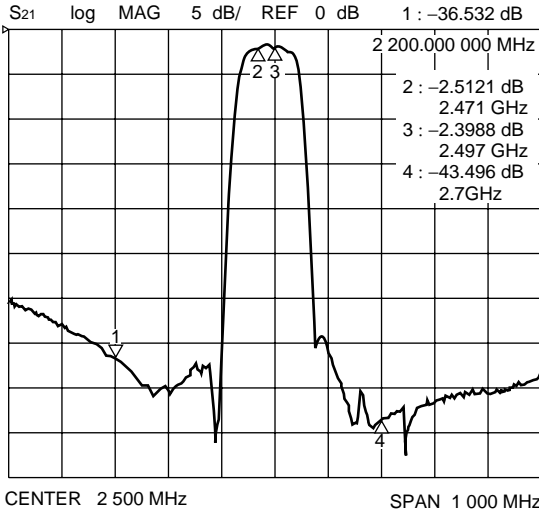

F6 Series (L2 type)

15. Wireless-LAN 83.5 MHz Band Width (For Europe, USA)

Part number : FAR-F6CE-2G4418-L2WD

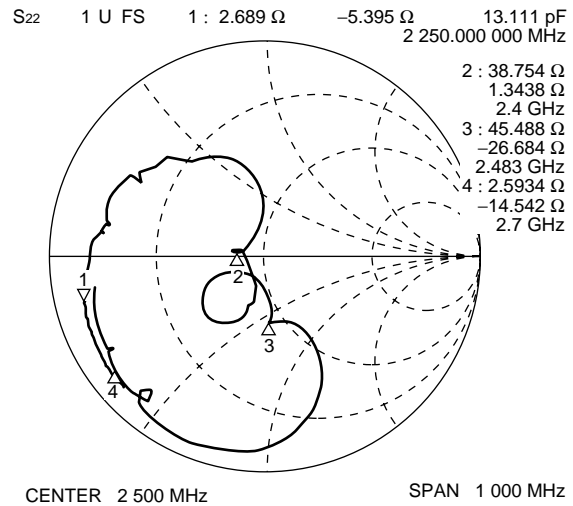
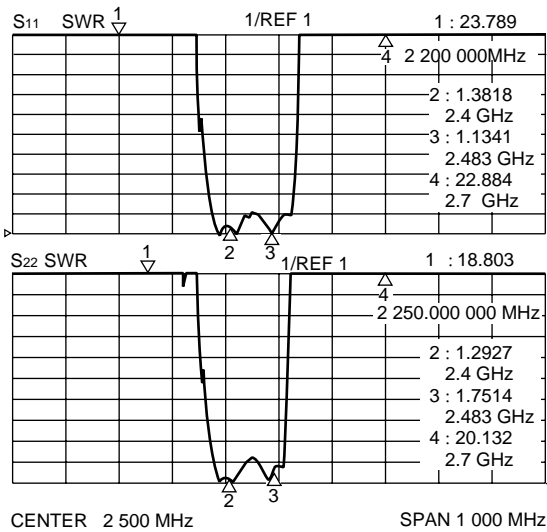
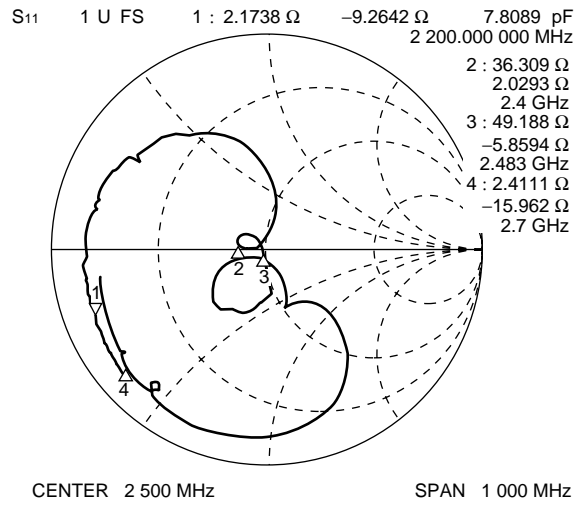
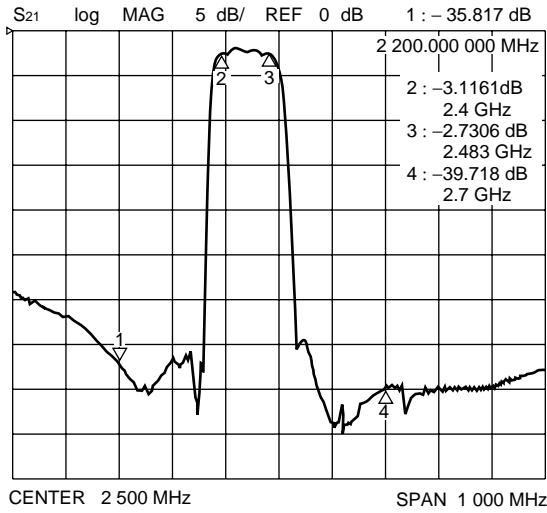

F6 Series (L2 type)

16. W-CDMA (Tx)

Part number : FAR-F6CE-1G9500-L2ZP

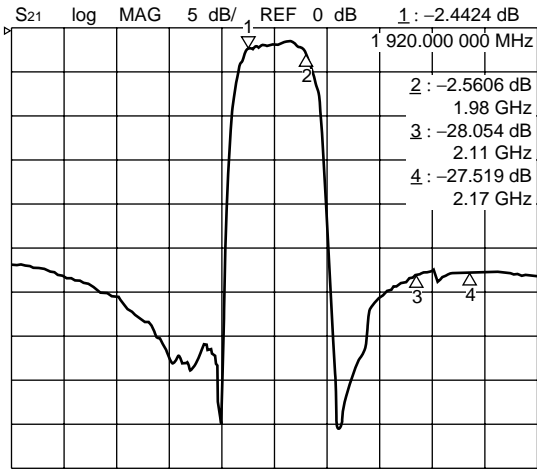

CENTER 1 950 MHz

SPAN 600 MHz

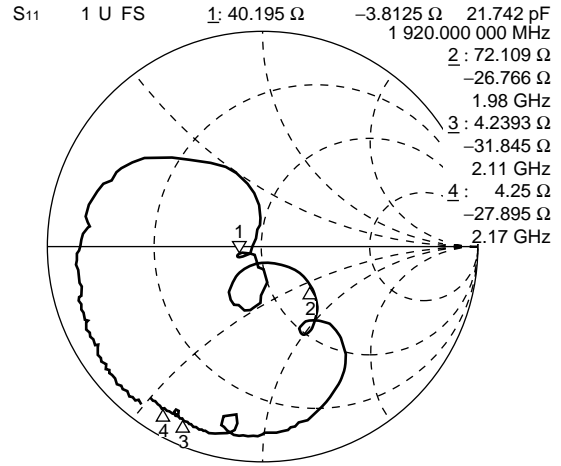

CENTER 1 950 MHz

SPAN 600 MHz

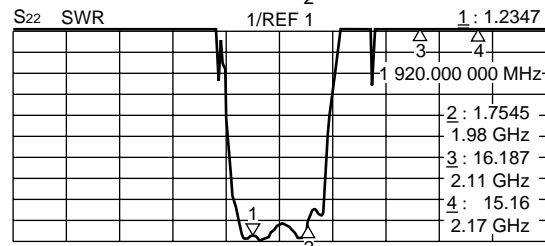
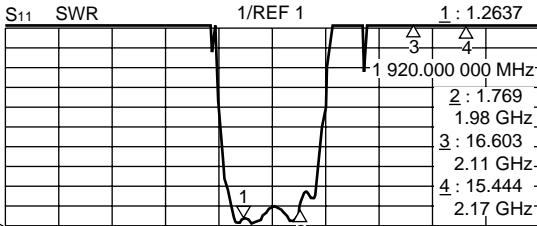

CENTER 1 950 MHz

SPAN 600 MHz

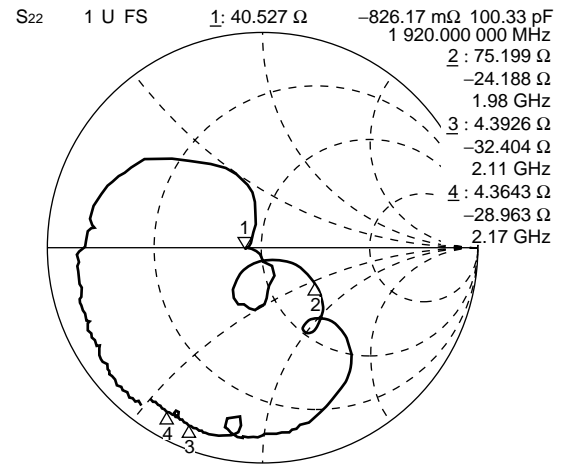

CENTER 1 950 MHz

SPAN 600 MHz

F6 Series (L2 type)

17. W-CDMA (Rx)

Part number : FAR-F6CE-2G1400-L2ZQ

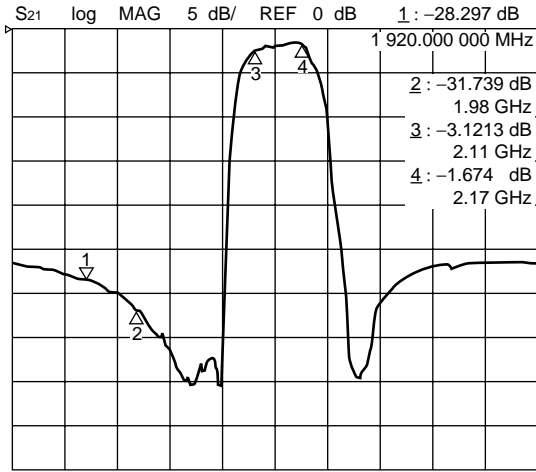

CENTER 2 140 MHz

SPAN 600 MHz

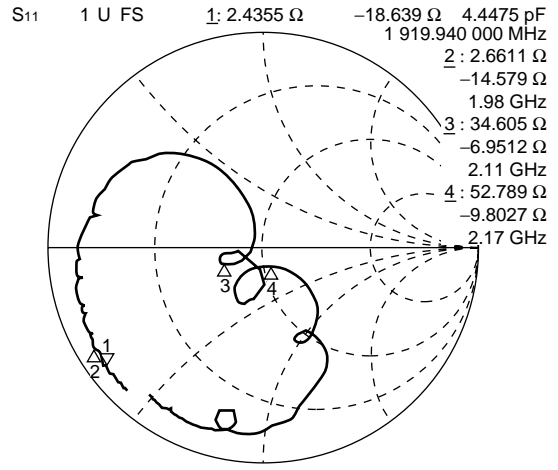

CENTER 2 140 MHz

SPAN 600 MHz

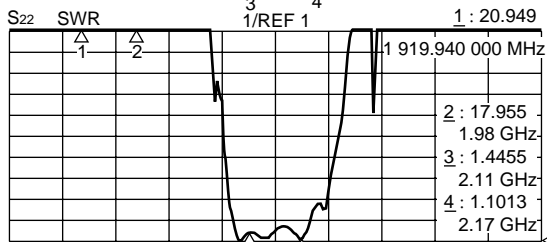
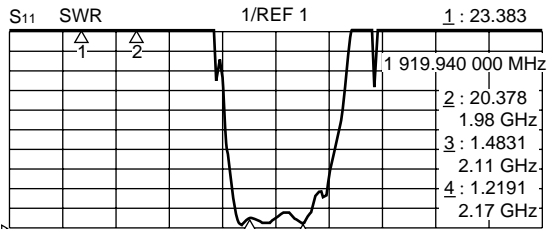

CENTER 2 140 MHz

SPAN 600 MHz

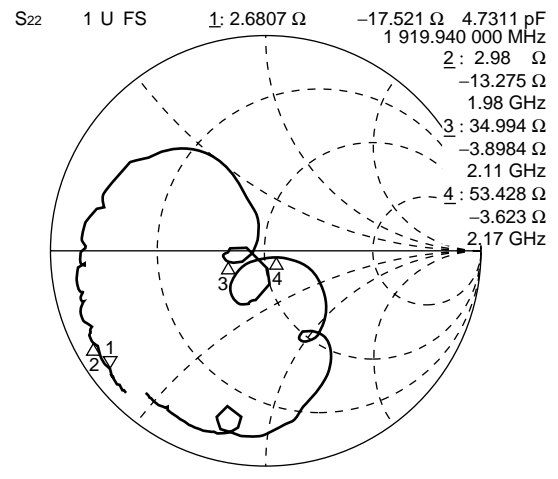

CENTER 2 140 MHz

SPAN 600 MHz

F6 Series (L2 type)

18. Bluetooth

Part number : FAR-F6CE-2G4418-L2RB

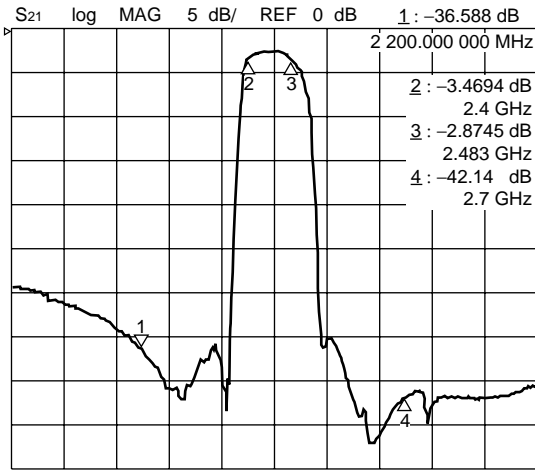

CENTER 2 450 MHz

SPAN 1 000 MHz

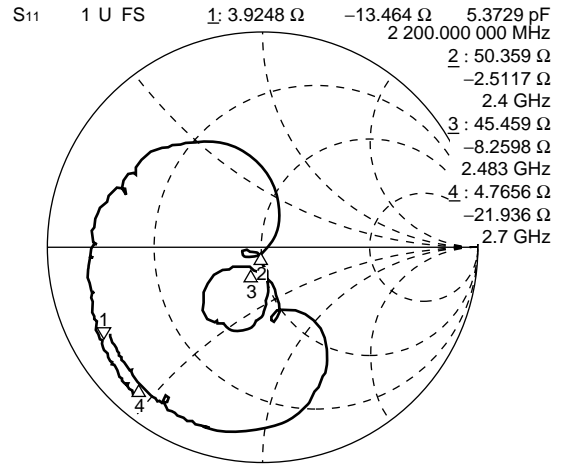

CENTER 2 450 MHz

SPAN 1 000 MHz

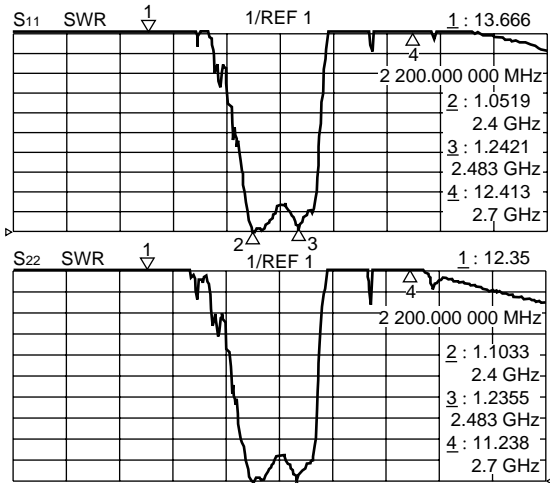

CENTER 2 450 MHz

SPAN 1 000 MHz

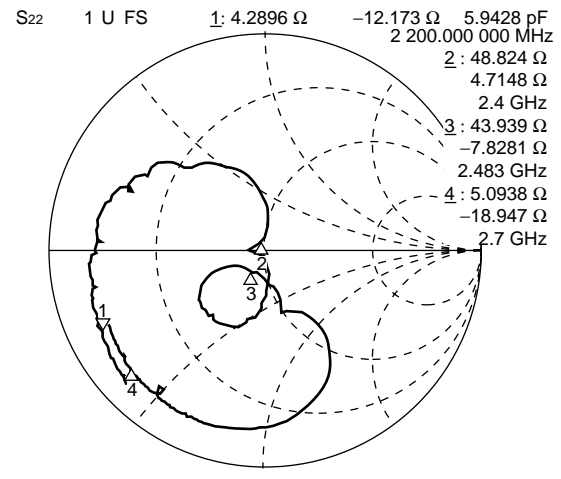

CENTER 2 450 MHz

SPAN 1 000 MHz

■ MARKING

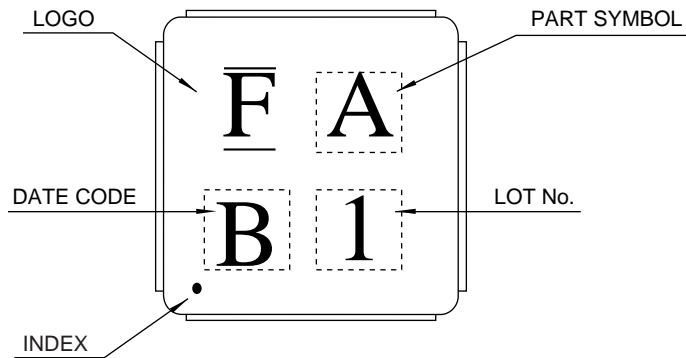

- In case that part symbol consists of two characters according to the part symbol specified in "■STANDARD FREQUENCIES".

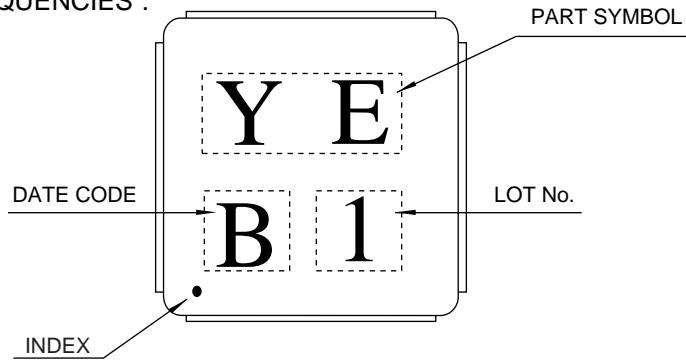

F6 Series (L2 type)

■ PACKAGE DIMENSIONS

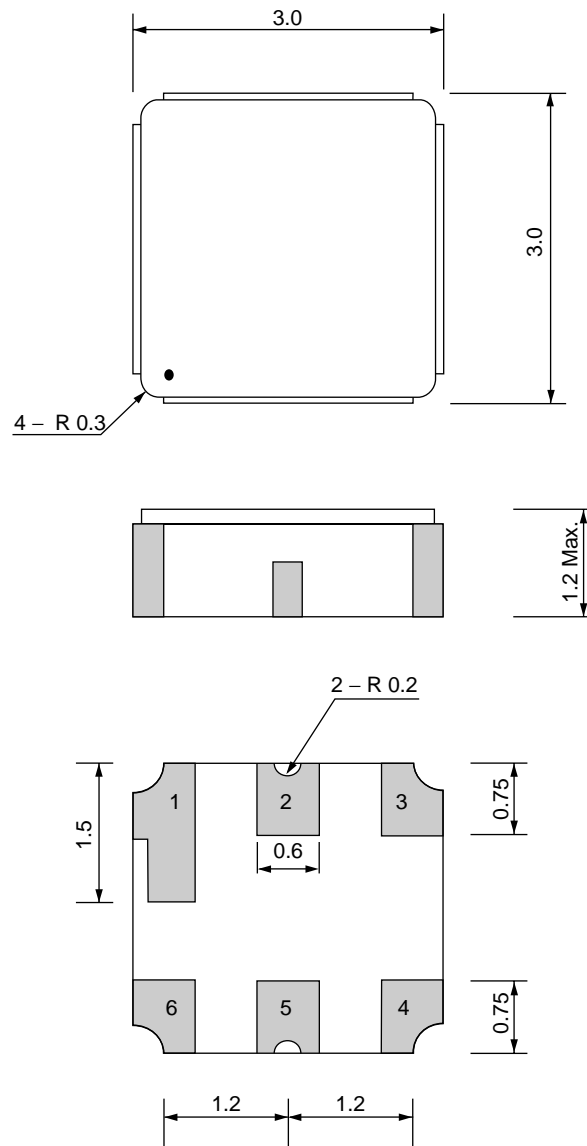

Dimensions in mm.

RECOMMENDED LAND PATTERN

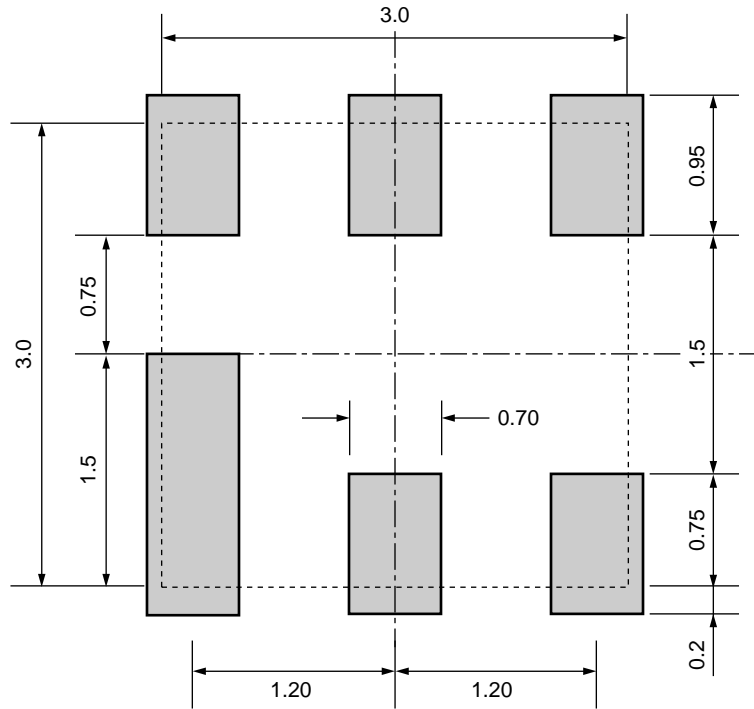

Dimensions in mm.

F6 Series (L2 type)

■ PACKING : Reel type

(1) Reel dimensions

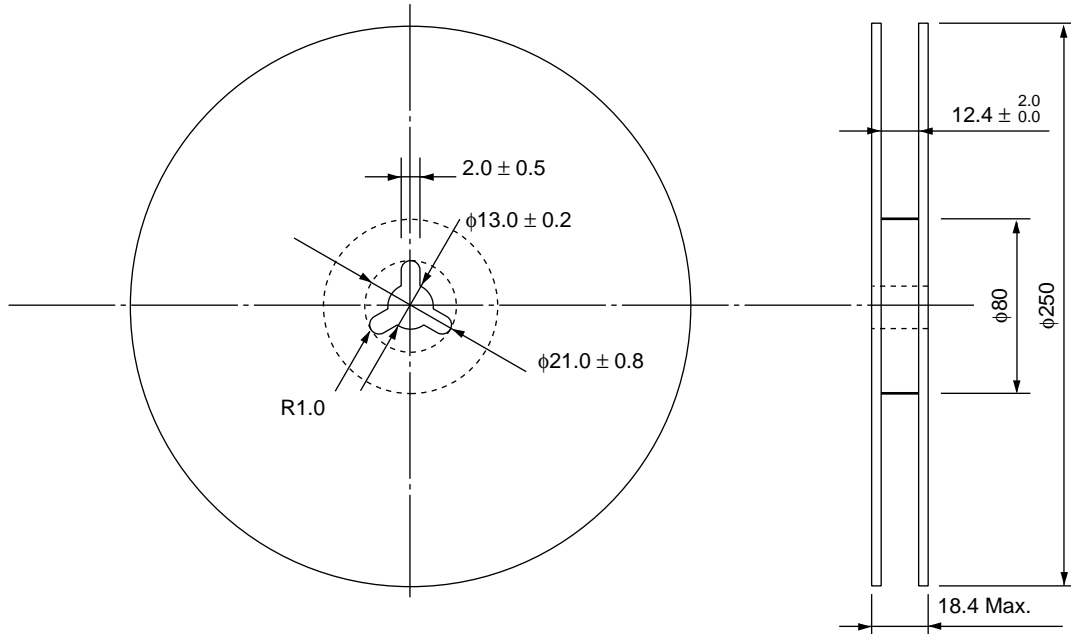

Type	Volume
-W	1 k pcs
-V	3 k pcs
-U	5 k pcs

Dimensions in mm.

(2) Packing style

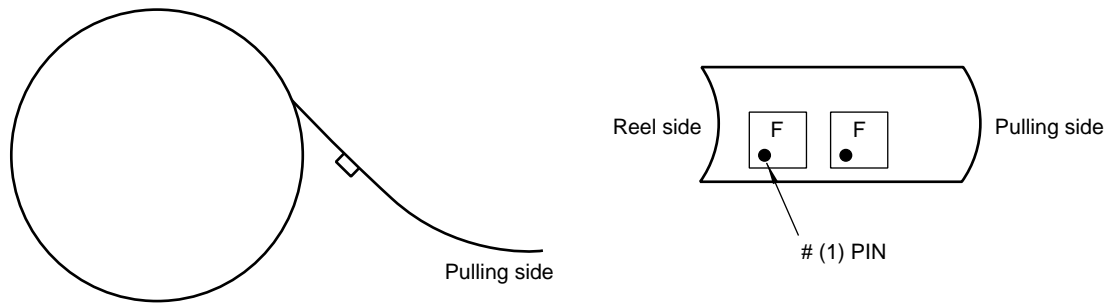

F6 Series (L2 type)

(3) Tape dimensions

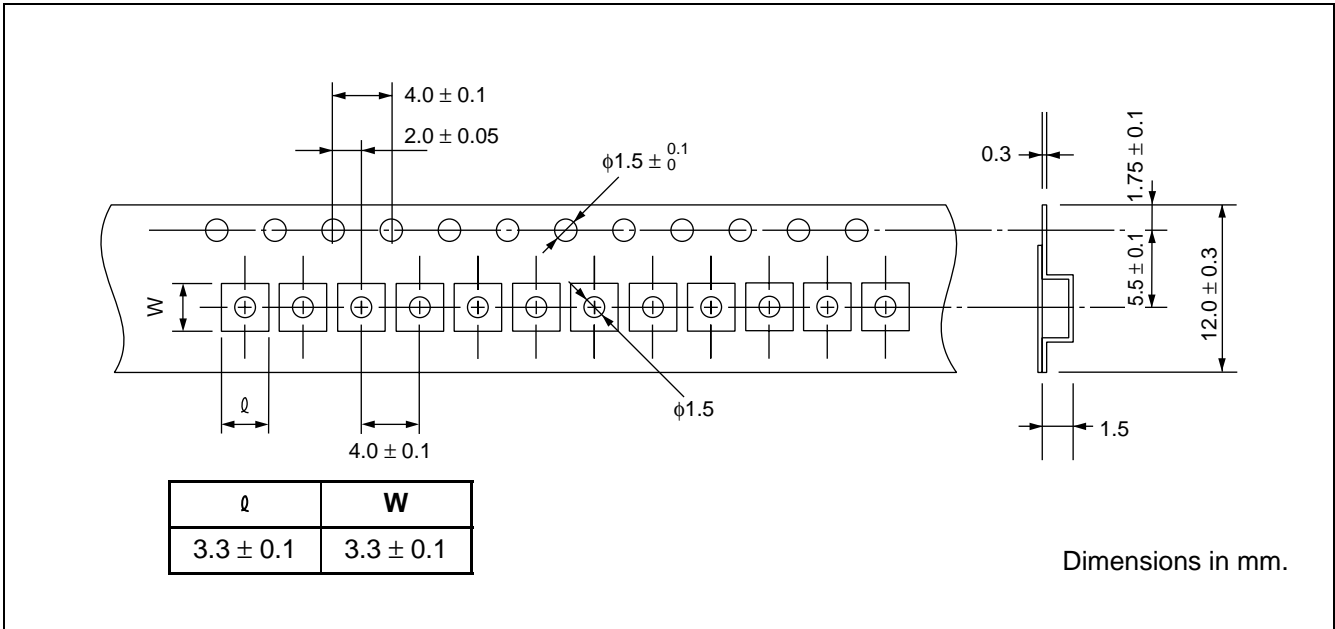

(4) Peel strength of top cover tape

Peel off by the force of 0.1 N to 0.7 N under the condition at the right.
(Conforms to JIS C 0806 section 5.2)

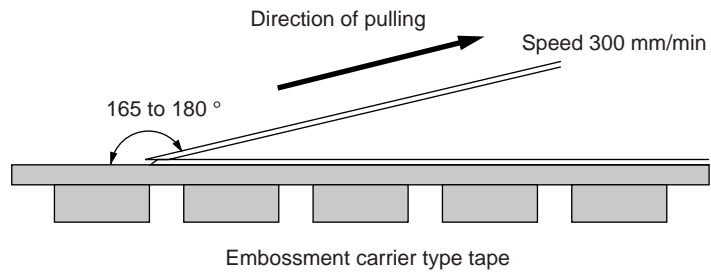

F6 Series (L2 type)

RECOMMENDED REFLOW PROFILE

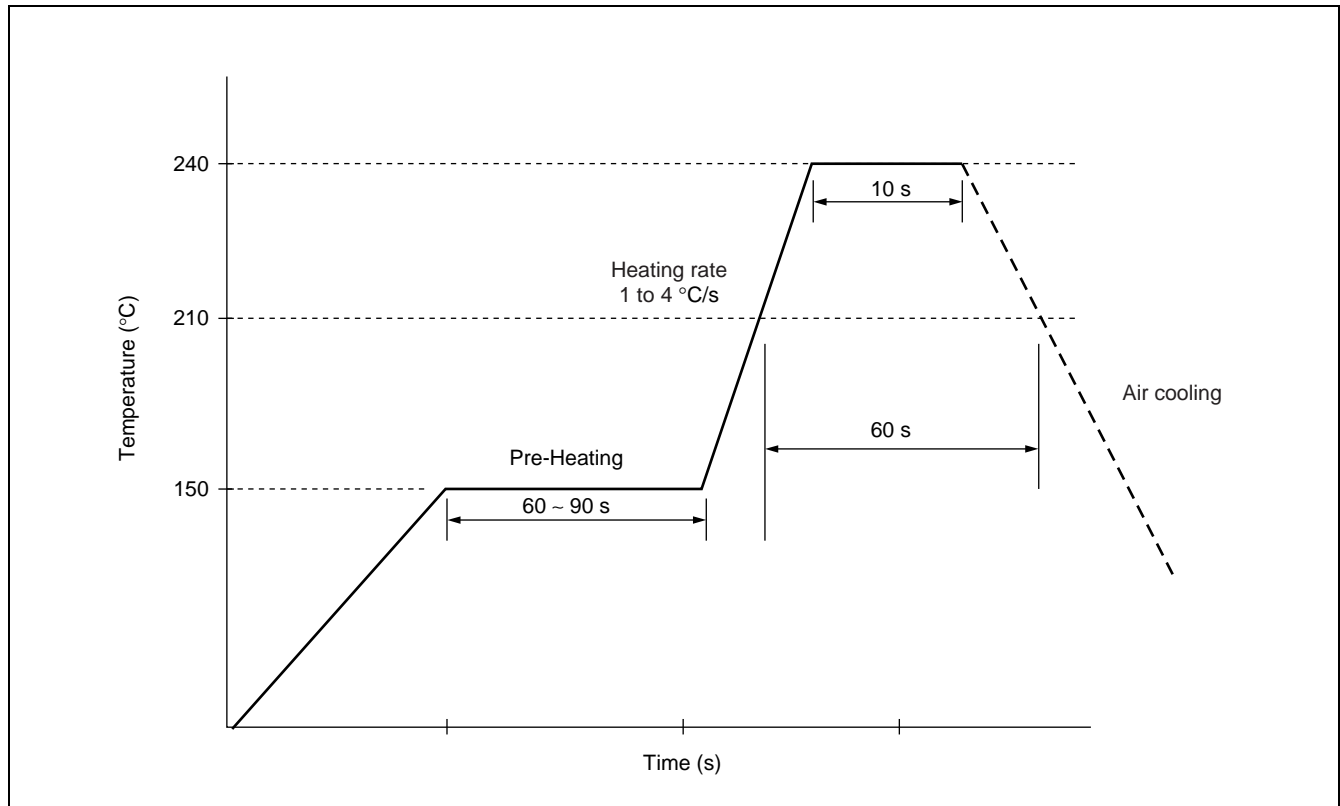

NOTE

Mass-produced product order is accepted by a unit of 1000.

F6 Series (L2 type)

FUJITSU MEDIA DEVICES LIMITED

For further information please contact:

Japan

FUJITSU MEDIA DEVICE LIMITED
International Sales & Marketing DEPT.
Shin-Yokohama Square Bldg., 14F,
Shin-yokohama 2-3-12,
Kohoku-ku, Yokohama,
Kanagawa 222-0033, Japan
Tel: +81-45-471-0061
Fax: +81-45-471-0076

<http://www.fujitsu.co.jp/hypertext/fmd/English/index.html>

North and South America

FUJITSU MICROELECTRONICS, INC.
3545 North First Street,
San Jose, CA 95134-1804, U.S.A.
Tel: +1-408-922-9000
Fax: +1-408-922-9179

Customer Response Center
Mon. - Fri.: 7 am - 5 pm (PST)
Tel: +1-800-866-8608
Fax: +1-408-922-9179

<http://www.fujitsumicro.com/>

Europe

FUJITSU MICROELECTRONICS EUROPE GmbH
Am Siebenstein 6-10,
D-63303 Dreieich-Buchsschlag,
Germany
Tel: +49-6103-690-0
Fax: +49-6103-690-122

<http://www.fujitsu-fme.com/>

Asia Pacific

FUJITSU MICROELECTRONICS ASIA PTE. LTD.
#05-08, 151 Lorong Chuan,
New Tech Park,
Singapore 556741
Tel: +65-281-0770
Fax: +65-281-0220

<http://www.fmap.com.sg/>

F0011

© FUJITSU LIMITED Printed in Japan

All Rights Reserved.

The contents of this document are subject to change without notice. Customers are advised to consult with FUJITSU sales representatives before ordering.

The information and circuit diagrams in this document are presented as examples of semiconductor device applications, and are not intended to be incorporated in devices for actual use. Also, FUJITSU is unable to assume responsibility for infringement of any patent rights or other rights of third parties arising from the use of this information or circuit diagrams.

The contents of this document may not be reproduced or copied without the permission of FUJITSU LIMITED.

FUJITSU semiconductor devices are intended for use in standard applications (computers, office automation and other office equipments, industrial, communications, and measurement equipments, personal or household devices, etc.).

CAUTION:

Customers considering the use of our products in special applications where failure or abnormal operation may directly affect human lives or cause physical injury or property damage, or where extremely high levels of reliability are demanded (such as aerospace systems, atomic energy controls, sea floor repeaters, vehicle operating controls, medical devices for life support, etc.) are requested to consult with FUJITSU sales representatives before such use. The company will not be responsible for damages arising from such use without prior approval.

Any semiconductor devices have inherently a certain rate of failure. You must protect against injury, damage or loss from such failures by incorporating safety design measures into your facility and equipment such as redundancy, fire protection, and prevention of over-current levels and other abnormal operating conditions.

If any products described in this document represent goods or technologies subject to certain restrictions on export under the Foreign Exchange and Foreign Trade Control Law of Japan, the prior authorization by Japanese government should be required for export of those products from Japan.