

■ General Description

The AME8890 is a fixed 1.2V of positive, linear regulator feature low quiescent current (30 μ A typ.) with low dropout voltage, making them ideal for battery applications. The space-saving SOT-23-5 package is attractive for "Pocket" and "Hand Held" applications.

This rugged device has both Thermal Shutdown, and Current Fold-back to prevent device failure under the "Worst" of operating conditions.

An additional feature is a "Power Good" detector, which pulls low when the output is out of regulation.

The AME8890 is stable with an output capacitor of 2.2 μ F or greater.

■ Features

- Very Low Dropout Voltage
- Guaranteed 150mA Output
- Accurate to within 3%
- 30 μ A Quiescent Current
- Over-Temperature Shutdown
- Current Limiting
- Short Circuit Current Fold-back
- Power Good Output Function
- Power-Saving Shutdown Mode
- Space-Saving SOT-25 (SOT-23-5)
- Low Temperature Coefficient

■ Applications

- Instrumentation
- Portable Electronics
- Wireless Devices
- Cordless Phones
- PC Peripherals
- Battery Powered Widgets
- Electronic Scales

■ Functional Block Diagram

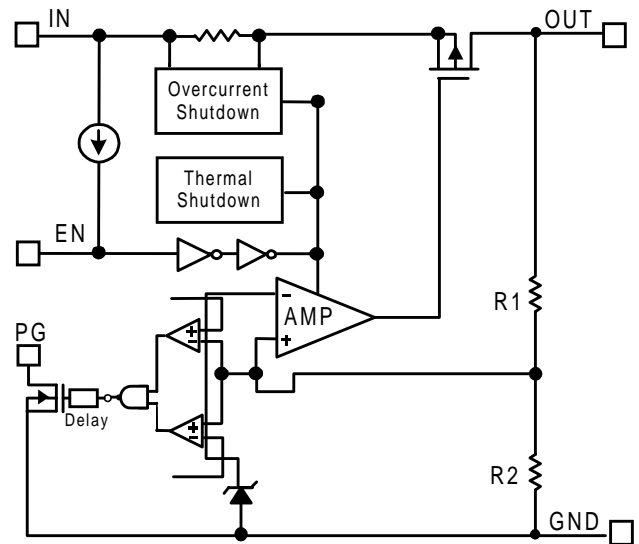

■ Typical Application

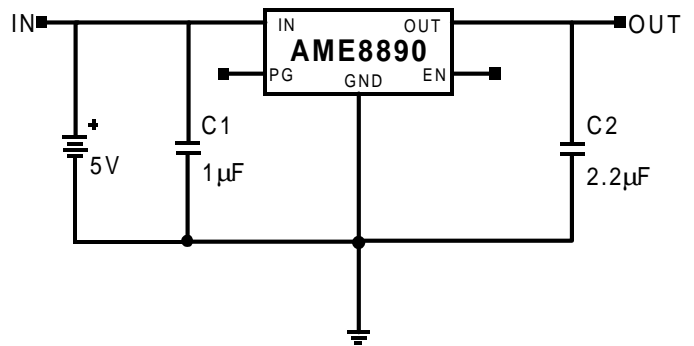



■ Pin Configuration

SOT-25 Top View

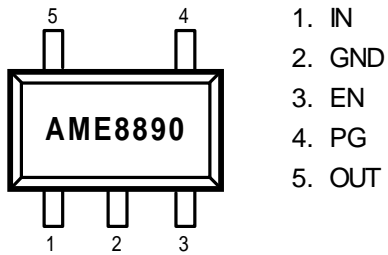

■ Ordering Information

Part Number	Marking	Output Voltage	Package	Operating Temp. Range
AME8890TEEV	ATBww	1.2V	SOT-25	-40°C to +85°C

ww: represents the date code

Please consult AME sales office or authorized Rep./Distributor for other package type availability.



■ Absolute Maximum Ratings

Parameter	Maximum	Unit
Input Voltage	7	V
Output Current	$P_D / (V_{IN} - V_O)$	mA
Output Voltage	GND - 0.3 to $V_{IN} + 0.3$	V
ESD Classification	B	

Caution: Stress above the listed absolute maximum rating may cause permanent damage to the device.

■ Recommended Operating Conditions

Parameter	Rating	Unit
Ambient Temperature Range	-40 to +85	°C
Junction Temperature	-40 to +125	°C

■ Thermal Information

Parameter		Maximum	Unit
Thermal Resistance (θ_{ja})	SOT-25	260	°C / W
Internal Power Dissipation (P_D) ($\Delta T = 100^\circ\text{C}$)	SOT-25	380	mW
Maximum Junction Temperature		150	°C
Maximum Lead Temperature (10 Sec)		300	°C

■ Electrical Specifications

$V_{IN} = 2.7V$, $V_{EN} = V_{IN}$, $I_{OUT} = 100\mu A$, $T_A = 25^\circ C$ unless otherwise noted

Parameter	Symbol	Test Condition	Min	Typ	Max	Units	
Input Voltage	V_{IN}		2.7		6	V	
Output Voltage Accuracy	V_O	$I_O = 0.1mA$	-3		3	%	
Dropout Voltage	$V_{DROPOUT}$	$I_O = 150mA$ $V_{OUT} = V_O - 2.0%$	$1.0V < V_{O(NOM)} \leq 2.0V$		1300	mV	
			$2.0V < V_{O(NOM)} \leq 2.8V$		N/A		
			$2.8V < V_{O(NOM)}$		N/A		
Current Limit	I_{LIM}	$V_O < 0.1V$	150	350		mA	
Quiescent Current	I_Q	$V_{IN} = 6V$, $I_O = 0mA$, $V_O = V_O(nom)$		30	50	μA	
Ground Pin Current	I_{GND}	$V_{IN} = 6V$, $I_O = 1mA$ to $150mA$		35		μA	
Line Regulation	REG_{LINE}	$I_O = 100\mu A$ $V_{IN} = 2.7V$ to $6V$	$1.0 \leq V_O \leq 2.0V$	-0.3	0.3	%	
Load Regulation	REG_{LOAD}	$I_O = 100\mu A$ to $150mA$		-4	1	4	%
Over Temperature Shutdown	OTS			150		$^\circ C$	
Over Temperature Hysteresis	OTH			30		$^\circ C$	
V_O Temperature Coefficient	TC			30		ppm/ $^\circ C$	
Power Supply Rejection	PSRR	$I_O = 100mA$ $C_O = 2.2\mu F$	$f = 1kHz$		50		
			$f = 10kHz$		20		dB
			$f = 100kHz$		15		
Output Voltage Noise	eN	$f = 10Hz$ to $100kHz$ $I_O = 10mA$			30	μV_{rms}	
EN Input Threshold	V_{EH}		1.6		V_{in}	V	
	V_{EL}		0		0.4	V	
EN Input Bias Current	I_{EH}	$V_{EN} = V_{IN}$		0.1		μA	
	I_{EL}	$V_{EN} = 0V$		0.1		μA	
Shutdown Supply Current	I_{SD}	$V_{IN} = 5V$, $V_O = 0V$, $V_{EN} = 0V$		0.5	1	μA	
Shutdown Output Voltage	$V_{O,SD}$	Output Loading $\leq 1200\ ohm$, $V_{EN} = 0V$	0		0.4	V	
Output Under Voltage	V_{UV}	PG ON @ % of V_{OUT}			95	% $V_{O(NOM)}$	
PG Leakage Current	I_{LC}	$V_{PG} = 6V$, PG is off		0.1		μA	
PG Voltage Low	V_{OL}	$I_{SINK} = 0.1mA$			0.1	V	
V_{PG} Delay	T_{PGD}	See Timing Diagram on page 6	1.5		5	ms	

Note1: $V_{IN(min)} = V_{OUT} + V_{DROPOUT}$

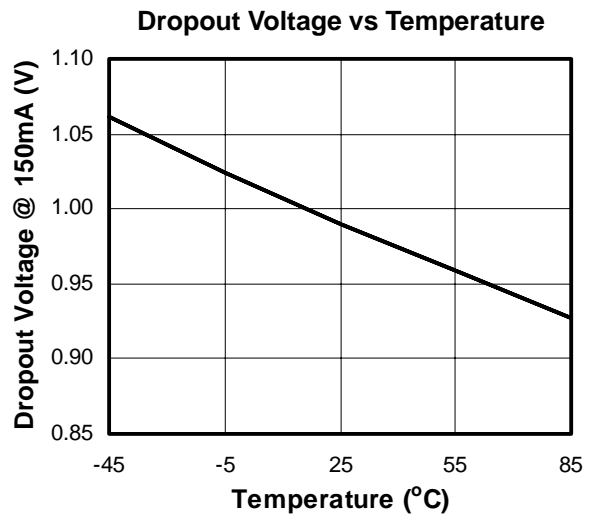
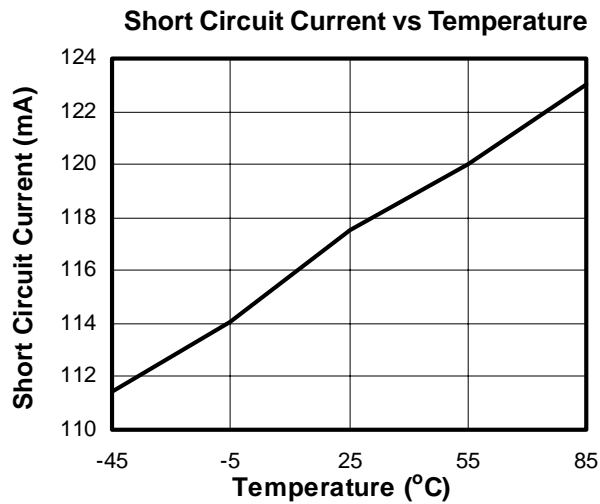
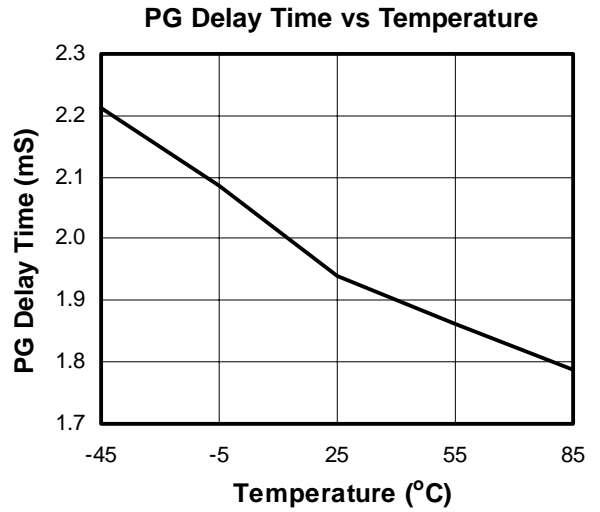
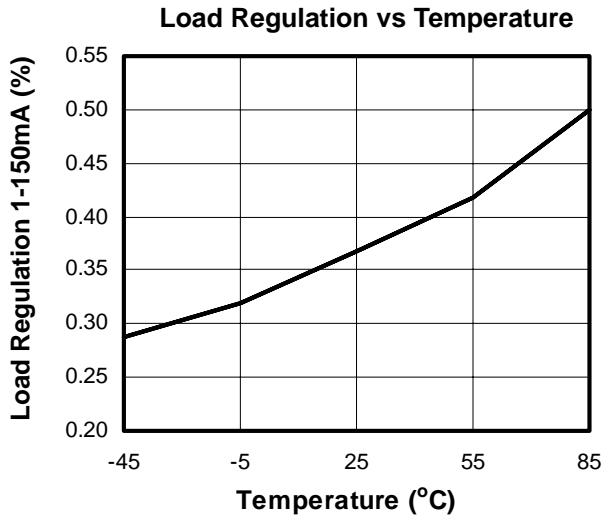
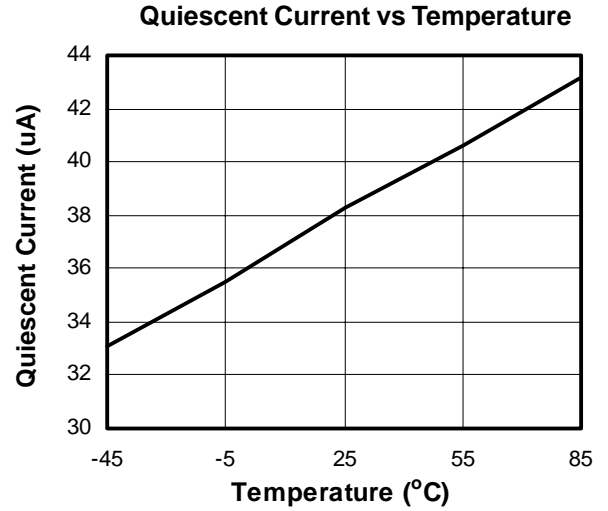
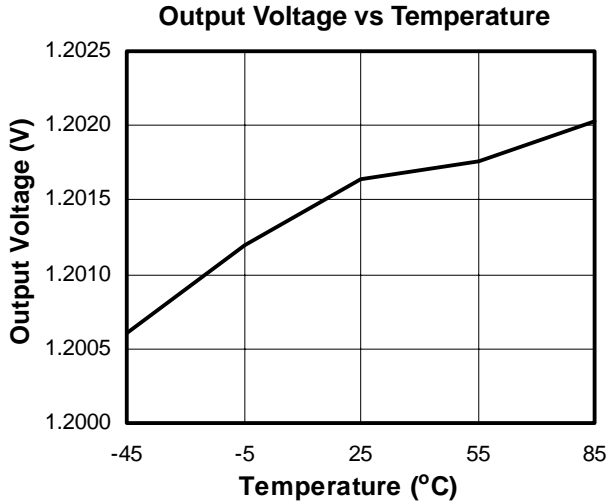



■ Timing Diagram

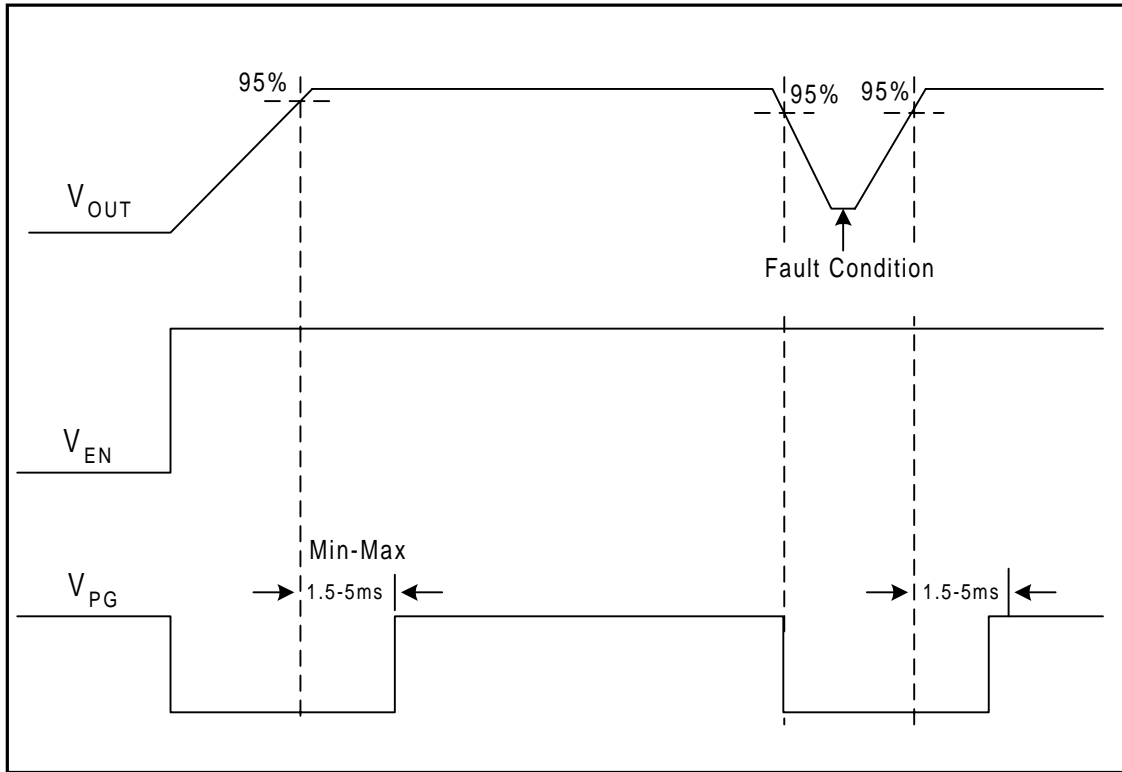



■ Package Dimension

SOT-25

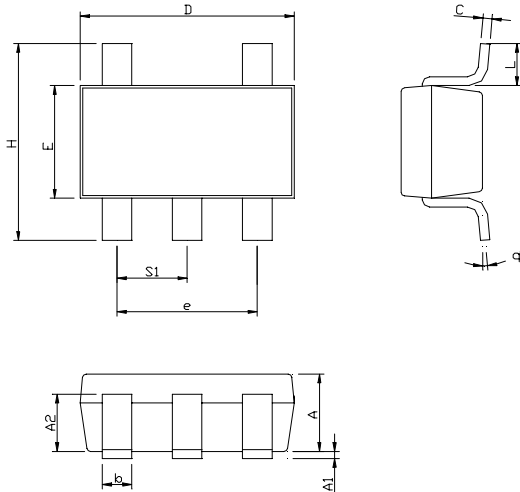

SYMBOLS	MILLIMETERS		INCHES	
	MIN	MAX	MIN	MAX
A	1.00	1.45	0.0394	0.0571
A₁	0.00	0.15	0.0000	0.0591
A₂	0.70	1.25	0.0276	0.0492
b	0.35	0.55	0.0138	0.0217
C	0.08	0.25	0.0031	0.0098
D	2.70	3.10	0.1063	0.1220
E	1.40	1.80	0.0551	0.0709
e	1.90 BSC		0.07480 BSC	
H	2.60	3.00	0.1024	0.1181
L	0.30	-	0.0118	-
θ_1	0°	10°	0°	10°
S₁	0.85	1.05	0.0335	0.0413



www.ame.com.tw
E-Mail: info@ame.com.tw

Life Support Policy:

These products of AME, Inc. are not authorized for use as critical components in life-support devices or systems, without the express written approval of the president of AME, Inc.

AME, Inc. reserves the right to make changes in the circuitry and specifications of its devices and advises its customers to obtain the latest version of relevant information.

© AME, Inc. , June 2002

Document: 2006-DS8890-A

U.S. Headquarter
Analog Microelectronics, Inc.

3100 De La Cruz Blvd. Suite 201
Santa Clara, CA. 95054-2046
Tel : (408) 988-2388
Fax: (408) 988-2489

Corporate Headquarter
AME, Inc.

2F, 189 Kang-Chien Road, Nei-Hu District
Taipei 114, Taiwan, R.O.C.
Tel : 886 2 2627-8687
Fax: 886 2 2659-2989