

3A High-Speed MOSFET Drivers

Features

- Latch-Up Protected: Will Withstand 500mA Reverse Current
- Input Will Withstand Negative Inputs Up to 5V
- ESD Protected: 4kV
- High Peak Output Current: 3A
- Wide Operating Range
 - 4.5V to 16V
- High Capacitive Load Drive Capability: 1800pF in 20nsec
- Short Delay Time: 35nsec Typ
- Consistent Delay Times With Changes in Supply Voltage
- Matched Delay Times
- Low Supply Current
 - With Logic "1" Input: 500 μ A
 - With Logic "0" Input: 100 μ A
- Low Output Impedance: 2.7 Ω
- Pinout Same as TC1410/TC1411/TC1412

Applications

- Switch Mode Power Supplies
- Line Drivers
- Pulse Transformer Drive
- Relay Driver

Device Selection Table

Part Number	Package	Temp. Range
TC1413COA	8-Pin SOIC	0°C to +70°C
TC1413CPA	8-Pin PDIP	0°C to +70°C
TC1413EOA	8-Pin SOIC	-40°C to +85°C
TC1413EPA	8-Pin PDIP	-40°C to +85°C
TC1413NCOA	8-Pin SOIC	0°C to +70°C
TC1413NCPA	8-Pin PDIP	0°C to +70°C
TC1413NEOA	8-Pin SOIC	-40°C to +85°C
TC1413NEPA	8-Pin PDIP	-40°C to +85°C

Package Type

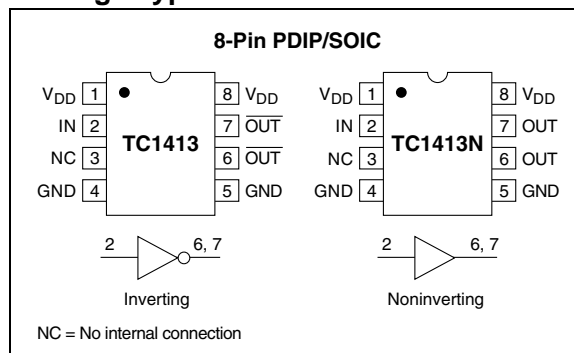

General Description

The TC1413/TC1413N are 3A CMOS buffer/drivers. They will not latch up under any conditions within their power and voltage ratings. They are not subject to damage when up to 5V of noise spiking of either polarity occurs on the ground pin. They can accept, without damage or logic upset, up to 500mA of current of either polarity being forced back into their output. All terminals are fully protected against up to 4kV of electrostatic discharge.

As MOSFET drivers, the TC1413/TC1413N can easily charge an 1800pF gate capacitance in 20nsec with matched rise and fall times, and provide low enough impedance in both the ON and the OFF states to ensure the MOSFET's intended state will not be affected, even by large transients. The rise and fall time edges are matched to allow driving short-duration inputs with greater accuracy.

TC1413/TC1413N

Functional Block Diagram

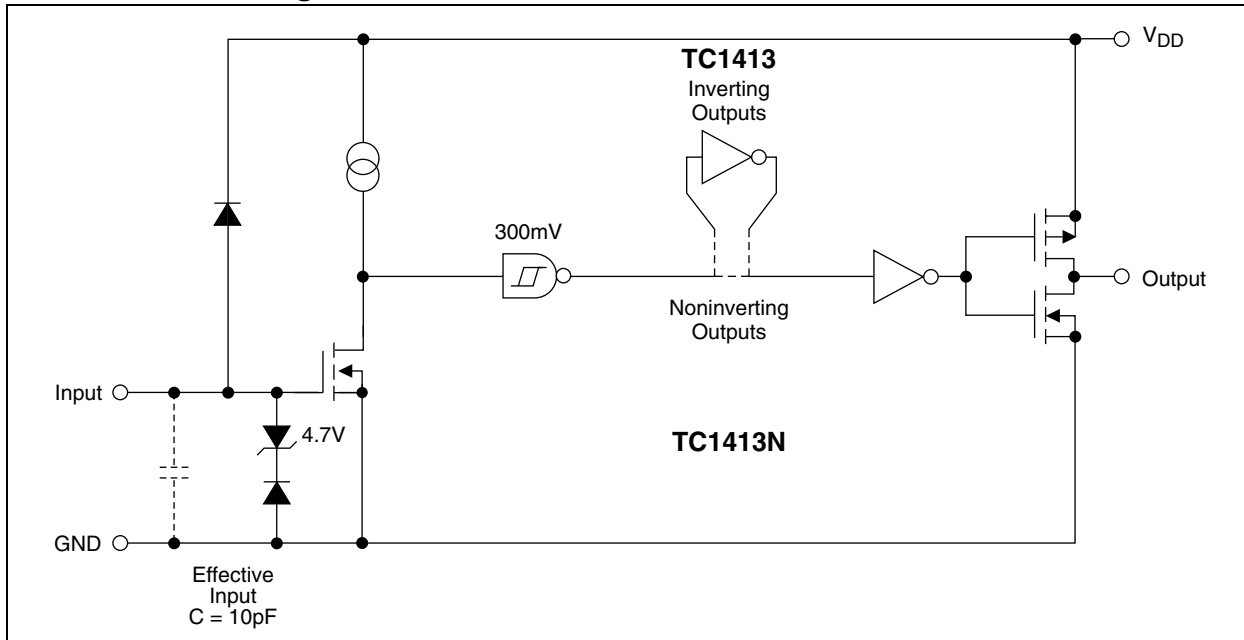

1.0 ELECTRICAL CHARACTERISTICS

Absolute Maximum Ratings*

Supply Voltage.....	+20V
Input Voltage.....	$V_{DD} + 0.3V$ to GND – 5.0V
Power Dissipation ($T_A \leq 70^\circ C$)	
PDIP	730mW
SOIC.....	470mW
Package Thermal Resistance	
PDIP $R_{\theta J-A}$	125°C/W
PDIP $R_{\theta J-C}$	42°C/W
SOIC $R_{\theta J-A}$	155°C/W
SOIC $R_{\theta J-C}$	45°C/W
Operating Temperature Range	
C Version.....	0°C to +70°C
E Version.....	-40°C to +85°C
Storage Temperature Range	-65°C to +150°C

*Stresses above those listed under "Absolute Maximum Ratings" may cause permanent damage to the device. These are stress ratings only and functional operation of the device at these or any other conditions above those indicated in the operation sections of the specifications is not implied. Exposure to Absolute Maximum Rating conditions for extended periods may affect device reliability.

TC1413/TC1413N ELECTRICAL SPECIFICATIONS

Electrical Characteristics: Over operating temperature range with $4.5V \leq V_{DD} \leq 16V$, unless otherwise noted. Typical values are measured at $T_A = +25^\circ C$, $V_{DD} = 16V$.

Symbol	Parameter	Min	Typ	Max	Units	Test Conditions
Input						
V_{IH}	Logic 1, High Input Voltage	2.0	—	—	V	
V_{IL}	Logic 0, Low Input Voltage	—	—	0.8	V	
I_{IN}	Input Current	-1 -10	—	1 10	μA	$0V \leq V_{IN} \leq V_{DD}$, $T_A = +25^\circ C$ $-40^\circ C \leq T_A \leq +85^\circ C$
Output						
V_{OH}	High Output Voltage	$V_{DD} - 0.025$	—	—	V	DC Test
V_{OL}	Low Output Voltage	—	—	0.025	V	DC Test
R_O	Output Resistance	—	2.7 3.3 3.3	4 5 5	Ω	$V_{DD} = 16V$, $I_O = 10mA$, $T_A = +25^\circ C$, $0^\circ C \leq T_A \leq +70^\circ C$ $-40^\circ C \leq T_A \leq +85^\circ C$
I_{PK}	Peak Output Current	—	2.0	—	A	$V_{DD} = 16V$
I_{REV}	Latch-Up Protection Withstand Reverse Current	—	0.5	—	A	Duty cycle $\leq 2\%$, $t \leq 300\mu sec$, $V_{DD} = 16V$

TC1413/TC1413N

TC1413/TC1413N ELECTRICAL SPECIFICATIONS (CONTINUED)

Electrical Characteristics: Over operating temperature range with $4.5V \leq V_{DD} \leq 16V$, unless otherwise noted. Typical values are measured at $T_A = +25^\circ C$, $V_{DD} = 16V$.

Symbol	Parameter	Min	Typ	Max	Units	Test Conditions
Switching Time (Note 1)						
t_R	Rise Time	—	20 22 24	28 33 33	nsec	$T_A = +25^\circ C$, $0^\circ C \leq T_A \leq +70^\circ C$ $-40^\circ C \leq T_A \leq +85^\circ C$, Figure 3-2
t_F	Fall Time	—	20 22 24	28 33 33	nsec	$T_A = +25^\circ C$, $0^\circ C \leq T_A \leq +70^\circ C$ $-40^\circ C \leq T_A \leq +85^\circ C$, Figure 3-2
t_{D1}	Delay Time	—	35 40 40	45 50 50	nsec	$T_A = +25^\circ C$, $0^\circ C \leq T_A \leq +70^\circ C$ $-40^\circ C \leq T_A \leq +85^\circ C$, Figure 3-2
t_{D2}	Delay Time	—	35 40 40	45 50 50	nsec	$T_A = +25^\circ C$, $0^\circ C \leq T_A \leq +70^\circ C$ $-40^\circ C \leq T_A \leq +85^\circ C$, Figure 3-2
Power Supply						
I_S	Power Supply Current	— —	0.5 0.1	1.0 0.15	mA	$V_{IN} = 3V$, $V_{DD} = 16V$ $V_{IN} = 0V$

Note 1: Switching times ensured by design.

2.0 PIN DESCRIPTIONS

The descriptions of the pins are listed in Table 2-1.

TABLE 2-1: PIN FUNCTION TABLE

Pin No. (8-Pin PDIP, SOIC)	Symbol	Description
1	V_{DD}	Supply input, 4.5V to 16V.
2	INPUT	Control input.
3	NC	No connection.
4	GND	Ground.
5	GND	Ground.
6	OUTPUT	CMOS totem-pole output, common to pin 7.
7	OUTPUT	CMOS totem-pole output, common to pin 6.
8	V_{DD}	Supply Input, 4.5V to 16V.

TC1413/TC1413N

3.0 APPLICATIONS INFORMATION

FIGURE 3-1: THERMAL DERATING CURVE

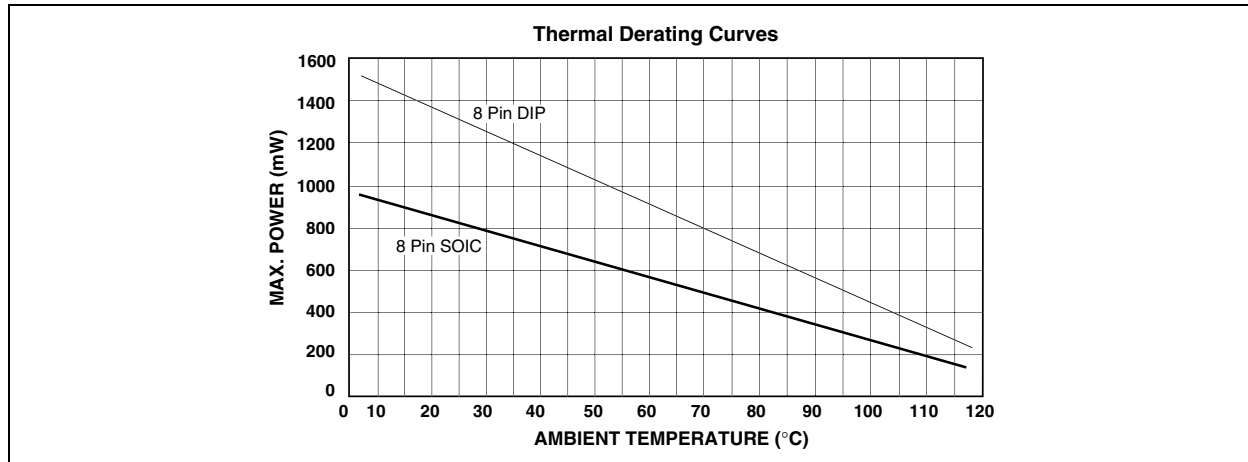
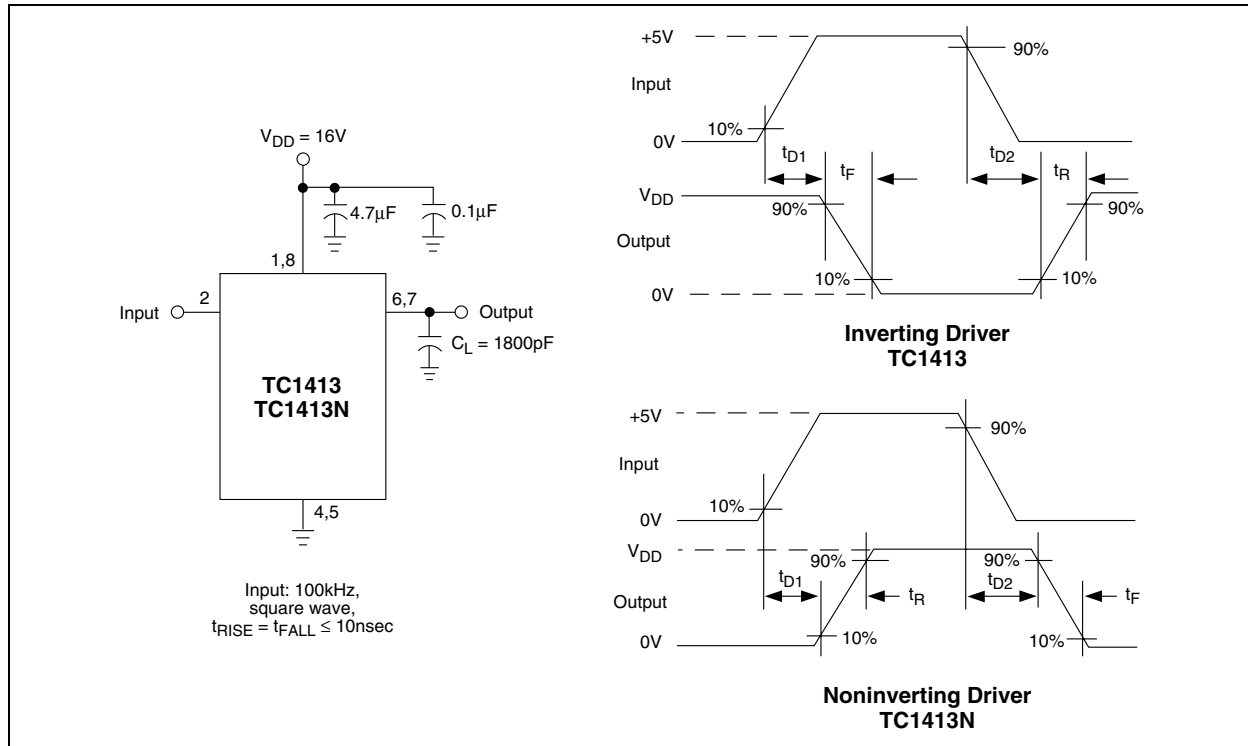
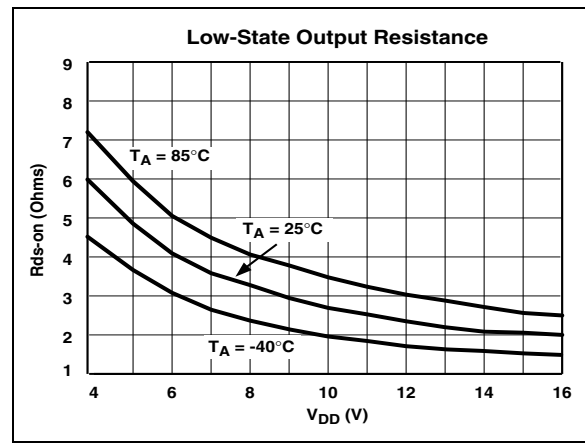
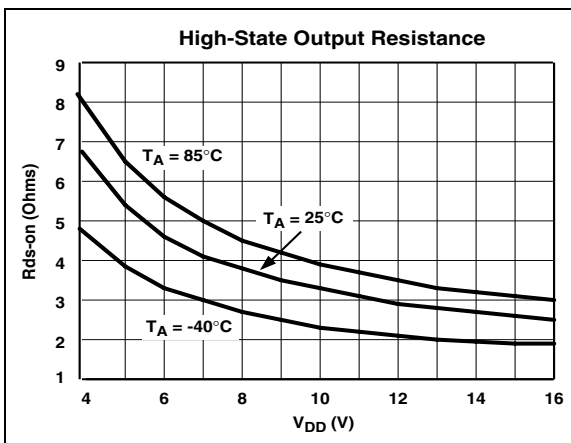
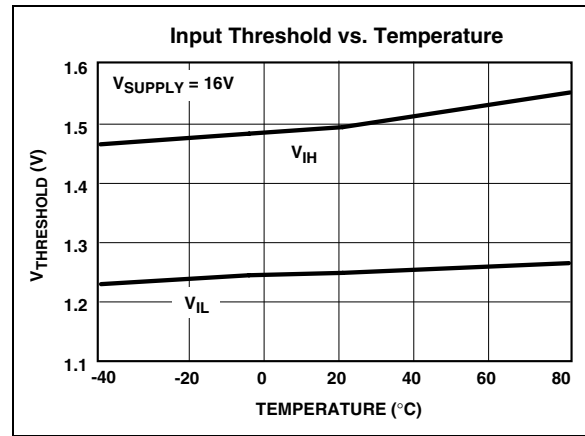
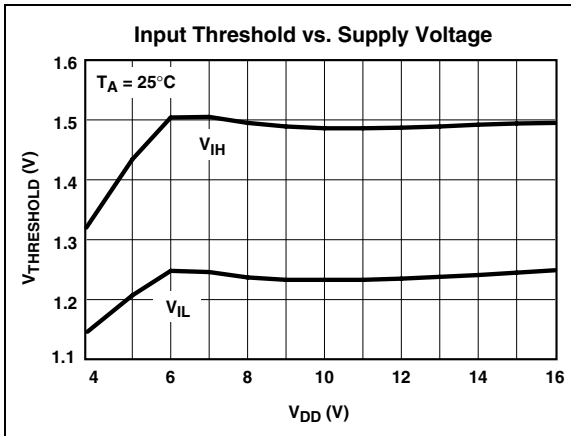
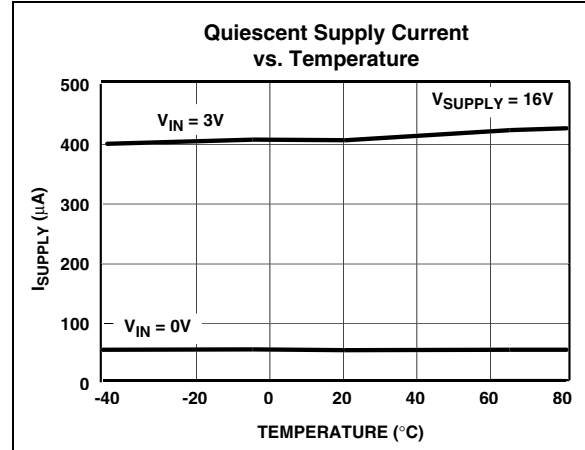
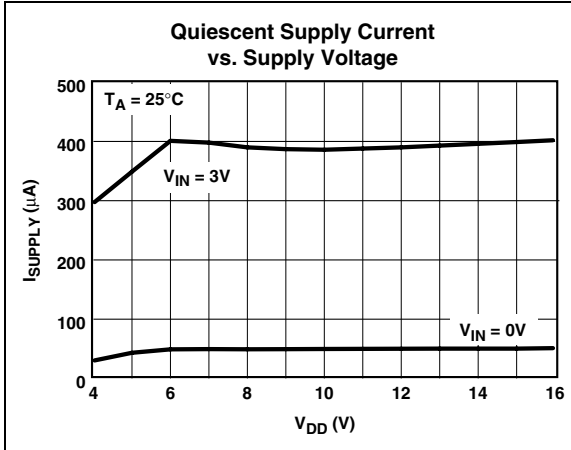

FIGURE 3-2: SWITCHING TIME TEST CIRCUIT



4.0 TYPICAL CHARACTERISTICS

Note: The graphs and tables provided following this note are a statistical summary based on a limited number of samples and are provided for informational purposes only. The performance characteristics listed herein are not tested or guaranteed. In some graphs or tables, the data presented may be outside the specified operating range (e.g., outside specified power supply range) and therefore outside the warranted range.



TC1413/TC1413N

TYPICAL CHARACTERISTICS (CONTINUED)

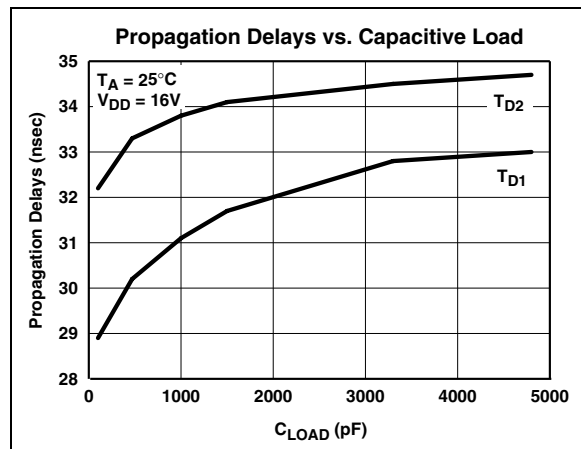
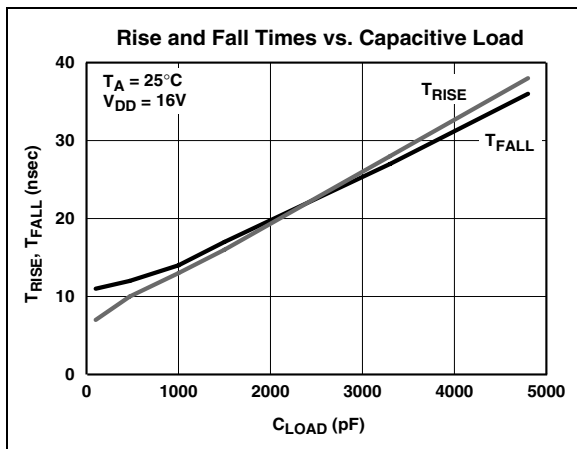
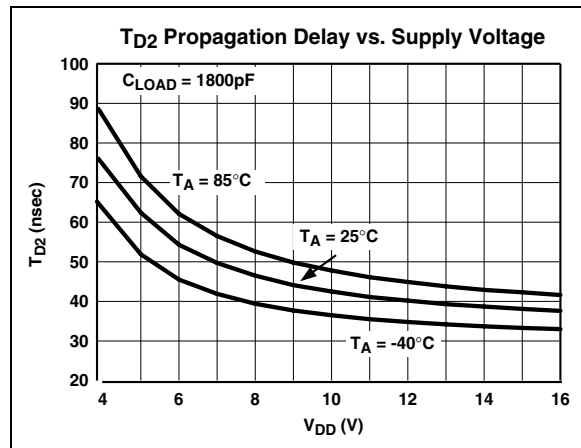
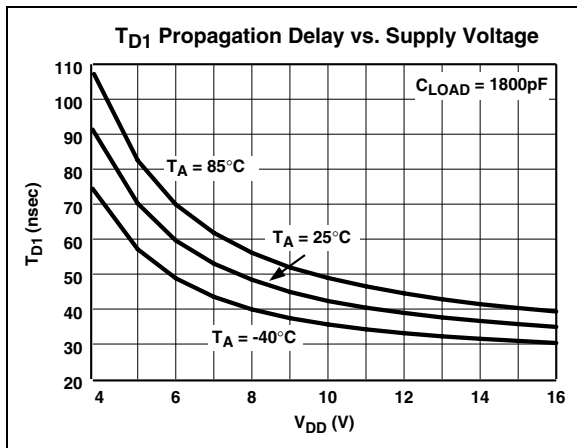
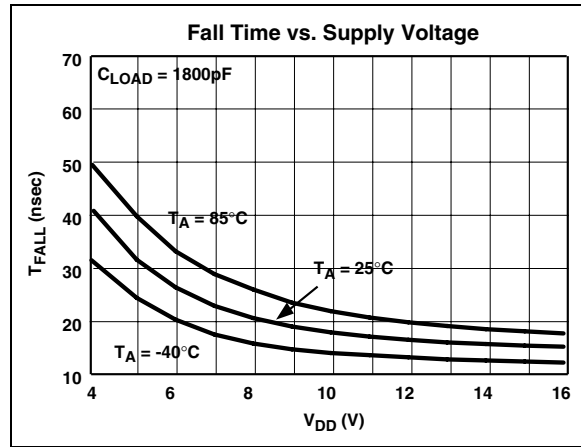
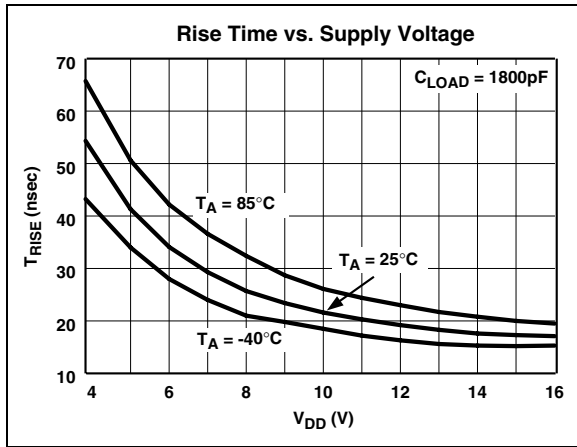

5.0 PACKAGING INFORMATION

5.1 Package Marking Information

Package marking data not available at this time.

5.2 Package Dimensions

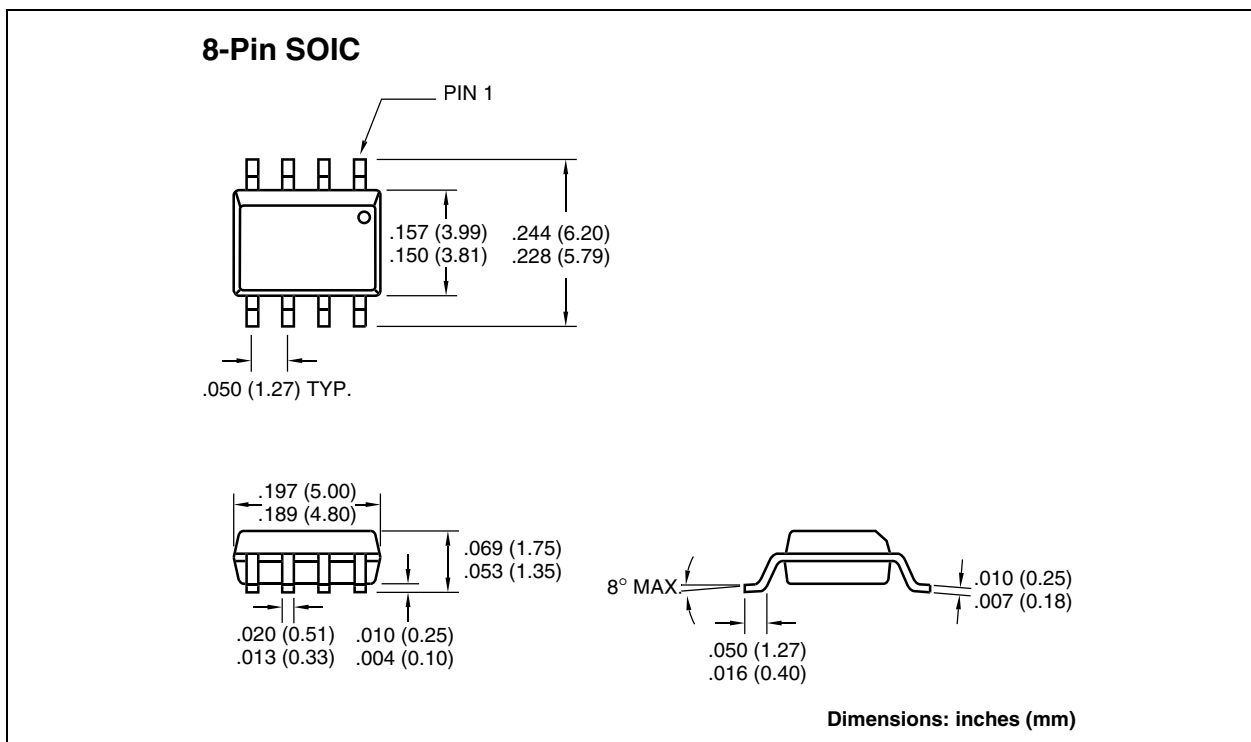
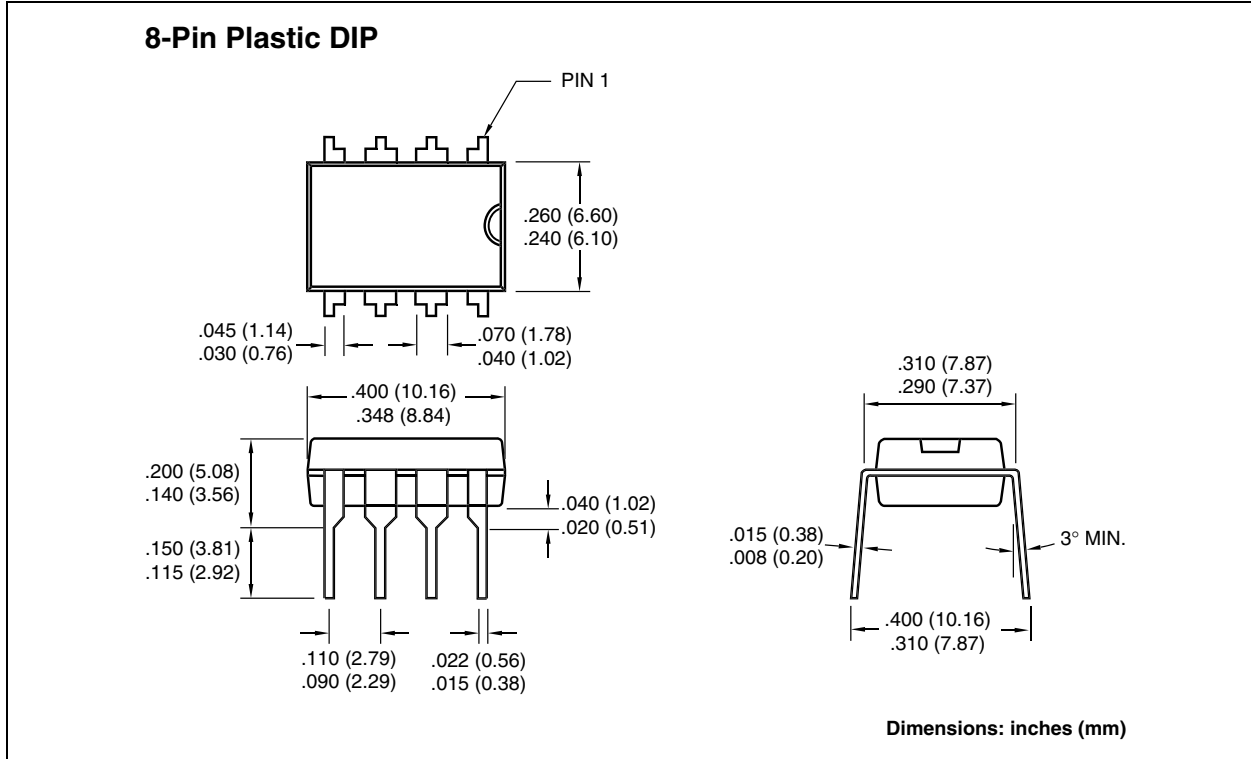

TC1413/TC1413N

NOTES:

Sales and Support

Data Sheets

Products supported by a preliminary Data Sheet may have an errata sheet describing minor operational differences and recommended workarounds. To determine if an errata sheet exists for a particular device, please contact one of the following:

1. Your local Microchip sales office
2. The Microchip Corporate Literature Center U.S. FAX: (480) 792-7277
3. The Microchip Worldwide Site (www.microchip.com)

Please specify which device, revision of silicon and Data Sheet (include Literature #) you are using.

New Customer Notification System

Register on our web site (www.microchip.com/cn) to receive the most current information on our products.

TC1413/TC1413N

NOTES:

Information contained in this publication regarding device applications and the like is intended through suggestion only and may be superseded by updates. It is your responsibility to ensure that your application meets with your specifications. No representation or warranty is given and no liability is assumed by Microchip Technology Incorporated with respect to the accuracy or use of such information, or infringement of patents or other intellectual property rights arising from such use or otherwise. Use of Microchip's products as critical components in life support systems is not authorized except with express written approval by Microchip. No licenses are conveyed, implicitly or otherwise, under any intellectual property rights.

Trademarks

The Microchip name and logo, the Microchip logo, FilterLab, KEELOQ, microID, MPLAB, PIC, PICmicro, PICMASTER, PICSTART, PRO MATE, SEEVAL and The Embedded Control Solutions Company are registered trademarks of Microchip Technology Incorporated in the U.S.A. and other countries.

dsPIC, ECONOMONITOR, FanSense, FlexROM, fuzzyLAB, In-Circuit Serial Programming, ICSP, ICEPIC, microPort, Migratable Memory, MPASM, MPLIB, MPLINK, MPSIM, MXDEV, PICC, PICDEM, PICDEM.net, rfPIC, Select Mode and Total Endurance are trademarks of Microchip Technology Incorporated in the U.S.A.

Serialized Quick Turn Programming (SQTP) is a service mark of Microchip Technology Incorporated in the U.S.A.

All other trademarks mentioned herein are property of their respective companies.

© 2002, Microchip Technology Incorporated, Printed in the U.S.A., All Rights Reserved.

 Printed on recycled paper.

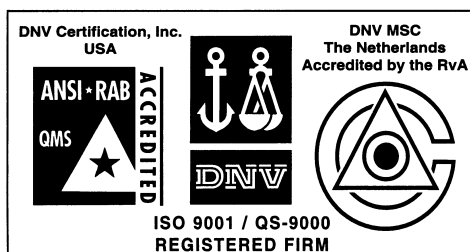

Microchip received QS-9000 quality system certification for its worldwide headquarters, design and wafer fabrication facilities in Chandler and Tempe, Arizona in July 1999 and Mountain View, California in March 2002. The Company's quality system processes and procedures are QS-9000 compliant for its PICmicro® 8-bit MCUs, KEELOQ® code hopping devices, Serial EEPROMs, microperipherals, non-volatile memory and analog products. In addition, Microchip's quality system for the design and manufacture of development systems is ISO 9001 certified.



MICROCHIP

WORLDWIDE SALES AND SERVICE

AMERICAS

Corporate Office

2355 West Chandler Blvd.
Chandler, AZ 85224-6199
Tel: 480-792-7200 Fax: 480-792-7277
Technical Support: 480-792-7627
Web Address: <http://www.microchip.com>

Rocky Mountain

2355 West Chandler Blvd.
Chandler, AZ 85224-6199
Tel: 480-792-7966 Fax: 480-792-7456

Atlanta

500 Sugar Mill Road, Suite 200B
Atlanta, GA 30350
Tel: 770-640-0034 Fax: 770-640-0307

Boston

2 Lan Drive, Suite 120
Westford, MA 01886
Tel: 978-692-3848 Fax: 978-692-3821

Chicago

333 Pierce Road, Suite 180
Itasca, IL 60143
Tel: 630-285-0071 Fax: 630-285-0075

Dallas

4570 Westgrove Drive, Suite 160
Addison, TX 75001
Tel: 972-818-7423 Fax: 972-818-2924

Detroit

Tri-Atria Office Building
32255 Northwestern Highway, Suite 190
Farmington Hills, MI 48334
Tel: 248-538-2250 Fax: 248-538-2260

Kokomo

2767 S. Albright Road
Kokomo, Indiana 46902
Tel: 765-864-8360 Fax: 765-864-8387

Los Angeles

18201 Von Karman, Suite 1090
Irvine, CA 92612
Tel: 949-263-1888 Fax: 949-263-1338

New York

150 Motor Parkway, Suite 202
Hauppauge, NY 11788
Tel: 631-273-5305 Fax: 631-273-5335

San Jose

Microchip Technology Inc.
2107 North First Street, Suite 590
San Jose, CA 95131
Tel: 408-436-7950 Fax: 408-436-7955

Toronto

6285 Northam Drive, Suite 108
Mississauga, Ontario L4V 1X5, Canada
Tel: 905-673-0699 Fax: 905-673-6509

ASIA/PACIFIC

Australia

Microchip Technology Australia Pty Ltd
Suite 22, 41 Rawson Street
Epping 2121, NSW
Australia
Tel: 61-2-9868-6733 Fax: 61-2-9868-6755

China - Beijing

Microchip Technology Consulting (Shanghai)
Co., Ltd., Beijing Liaison Office
Unit 915
Bei Hai Wan Tai Bldg.
No. 6 Chaoyangmen Beidajie
Beijing, 100027, No. China
Tel: 86-10-85282100 Fax: 86-10-85282104

China - Chengdu

Microchip Technology Consulting (Shanghai)
Co., Ltd., Chengdu Liaison Office
Rm. 2401, 24th Floor,
Ming Xing Financial Tower
No. 88 TIDU Street
Chengdu 610016, China
Tel: 86-28-6766200 Fax: 86-28-6766599

China - Fuzhou

Microchip Technology Consulting (Shanghai)
Co., Ltd., Fuzhou Liaison Office
Unit 28F, World Trade Plaza
No. 71 Wusi Road
Fuzhou 350001, China
Tel: 86-591-7503506 Fax: 86-591-7503521

China - Shanghai

Microchip Technology Consulting (Shanghai)
Co., Ltd.
Room 701, Bldg. B
Far East International Plaza
No. 317 Xian Xia Road
Shanghai, 200051
Tel: 86-21-6275-5700 Fax: 86-21-6275-5060

China - Shenzhen

Microchip Technology Consulting (Shanghai)
Co., Ltd., Shenzhen Liaison Office
Rm. 1315, 13/F, Shenzhen Kerry Centre,
Renminnan Lu
Shenzhen 518001, China
Tel: 86-755-2350361 Fax: 86-755-2366086

Hong Kong

Microchip Technology Hongkong Ltd.
Unit 901-6, Tower 2, Metroplaza
223 Hing Fong Road
Kwai Fong, N.T., Hong Kong
Tel: 852-2401-1200 Fax: 852-2401-3431

India

Microchip Technology Inc.
India Liaison Office
Divyasree Chambers
1 Floor, Wing A (A3/A4)
No. 11, O'Shaugnessey Road
Bangalore, 560 025, India
Tel: 91-80-2290061 Fax: 91-80-2290062

Japan

Microchip Technology Japan K.K.
Benex S-1 6F
3-18-20, Shinyokohama
Kohoku-Ku, Yokohama-shi
Kanagawa, 222-0033, Japan
Tel: 81-45-471- 6166 Fax: 81-45-471-6122

Korea

Microchip Technology Korea
168-1, Youngbo Bldg. 3 Floor
Samsung-Dong, Kangnam-Ku
Seoul, Korea 135-882
Tel: 82-2-554-7200 Fax: 82-2-558-5934

Singapore

Microchip Technology Singapore Pte Ltd.
200 Middle Road
#07-02 Prime Centre
Singapore, 188980
Tel: 65-6334-8870 Fax: 65-6334-8850

Taiwan

Microchip Technology Taiwan
11F-3, No. 207
Tung Hua North Road
Taipei, 105, Taiwan
Tel: 886-2-2717-7175 Fax: 886-2-2545-0139

EUROPE

Denmark

Microchip Technology Nordic ApS
Regus Business Centre
Lautrup høj 1-3
Ballerup DK-2750 Denmark
Tel: 45 4420 9895 Fax: 45 4420 9910

France

Microchip Technology SARL
Parc d'Activite du Moulin de Massy
43 Rue du Saule Trapu
Batiment A - 1er Etage
91300 Massy, France
Tel: 33-1-69-53-63-20 Fax: 33-1-69-30-90-79

Germany

Microchip Technology GmbH
Gustav-Heinemann Ring 125
D-81739 Munich, Germany
Tel: 49-89-627-144 0 Fax: 49-89-627-144-44

Italy

Microchip Technology SRL
Centro Direzionale Colleoni
Palazzo Taurus 1 V. Le Colleoni 1
20041 Agrate Brianza
Milan, Italy
Tel: 39-039-65791-1 Fax: 39-039-6899883

United Kingdom

Arizona Microchip Technology Ltd.
505 Eskdale Road
Winnersh Triangle
Wokingham
Berkshire, England RG41 5TU
Tel: 44 118 921 5869 Fax: 44-118 921-5820

03/01/02

