

## General Description

The PVT422P Series Photovoltaic Relay is a dual-pole, normally open solid-state relay that can replace electromechanical relays in many applications. It utilizes International Rectifier's HEXFET power MOSFET as the output switch, driven by an integrated circuit photovoltaic generator of novel construction. The output switch is controlled by radiation from a GaAlAs light emitting diode (LED) which is optically isolated from the photovoltaic generator.

PVT422P is ideally suited for PCMCIA card applications. Its extremely low profile allows it to be used in Type II cards whose outer shells are only 5mm thick.

Series PVT422P Relays are packaged in an 8-pin, molded 'Thin-Pak' DIP package with 'gull-wing' surface mount terminals. It is available in plastic shipping tubes or on tape-and-reel. Please refer to Part Identification (opposite) for details.

## Applications

- On/Off Hook switch ■
- Dial-Out relay ■
- Ring injection relay ■
- General switching ■

## PVT422P Features

- HEXFET Power MOSFET output ■
- Bounce-free operation ■
- 3,750 V<sub>RMS</sub> I/O isolation ■
- Linear AC/DC operation ■
- Solid-State reliability ■
- UL recognized ■

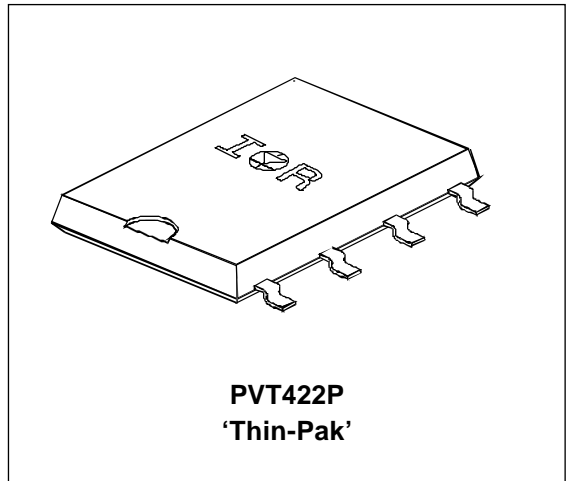

## Part Identification

PVT422P surface-mount, plastic shipping tube  
PVT422P-T surface-mount, tape-and-reel

**Electrical Specifications** ( $-40^{\circ}\text{C} \leq T_A \leq +85^{\circ}\text{C}$  unless otherwise specified)

INPUT CHARACTERISTICS	Limits	Units
Minimum Control Current (See figure 1)	2.0	mA
Maximum Control Current for Off-State Resistance @ $T_A=+25^{\circ}\text{C}$	0.4	mA
Control Current Range (Caution: current limit input LED, see figure 5)	2.0 to 25	mA
Maximum Reverse Voltage	7.0	V

OUTPUT CHARACTERISTICS	Limits	Units
Operating Voltage Range	0 to $\pm 400$	$V_{(DC \text{ or AC peak})}$
Maximum Load Current @ $T_A=+40^{\circ}\text{C}$ 5mA Control (See figure 1) (single and dual channel operation)	120	mA
Maximum Peak Load Current (10ms maximum duration) (single and dual channel operation)	350	mA
Maximum On-State Resistance @ $T_A=+25^{\circ}\text{C}$ For 50mA Pulsed load, 5mA Control (see figure 3)	35	$\Omega$
Maximum Off-State Leakage @ $T_A=+25^{\circ}\text{C}, \pm 320\text{V}$ (see figure 4)	1.0	$\mu\text{A}$
Maximum Turn-On Time @ $T_A=+25^{\circ}\text{C}$ (see figure 6) For 50mA, 100 $V_{DC}$ load, 5mA Control	2.0	ms
Maximum Turn-Off Time @ $T_A=+25^{\circ}\text{C}$ (see figure 6) For 50mA, 100 $V_{DC}$ load, 5mA Control	2.0	ms
Maximum Output Capacitance @ 50 $V_{DC}$	12	pF

GENERAL CHARACTERISTICS	Limits	Units	
Minimum Dielectric Strength, Input-Output	4000	$V_{RMS}$	
Minimum Dielectric Strength, Pole-to-Pole	1000	$V_{DC}$	
Minimum Insulation Resistance, Input-Output, @ $T_A=+25^{\circ}\text{C}, 50\%RH, 100V_{DC}$	$10^{12}$	$\Omega$	
Maximum Capacitance, Input-Output	1.0	pF	
Maximum Pin Soldering Temperature (10 seconds maximum)	+260	$^{\circ}\text{C}$	
Ambient Temperature Range:	Operating		-40 to +85
	Storage		-40 to +100

**Connection Diagram**

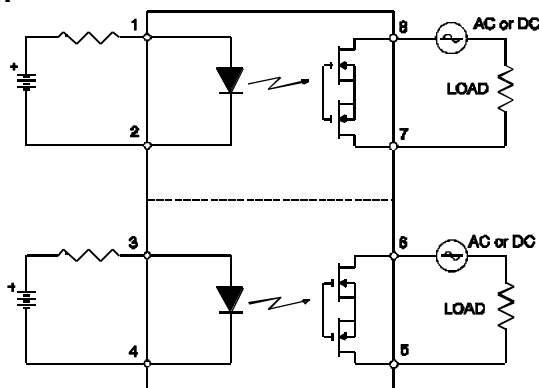

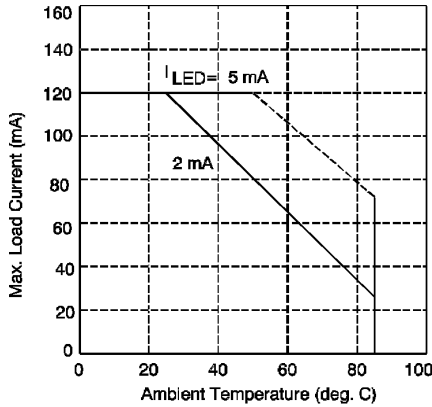

Figure 1. Typical Current Derating Curve

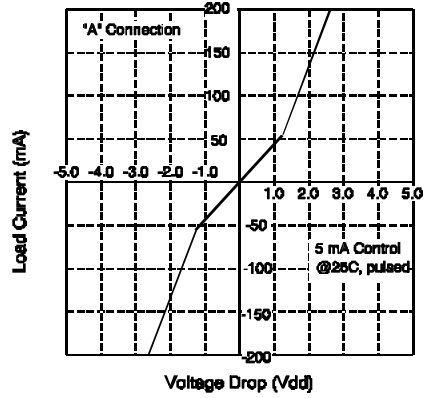

Figure 2. Linearity Characteristics

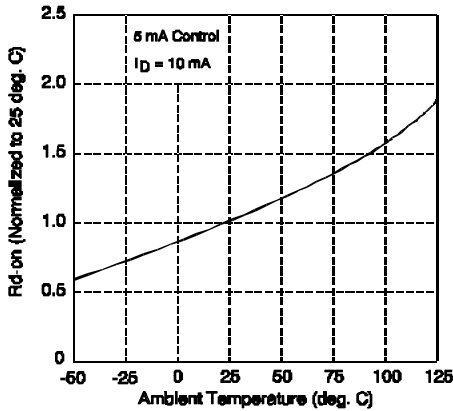

Figure 3. Typical Normalized On-Resistance

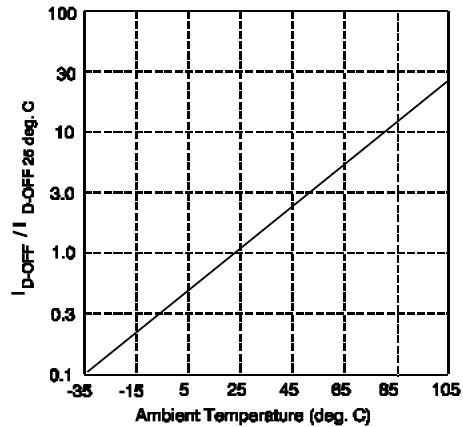

Figure 4. Typical Normalized Off-State Leakage

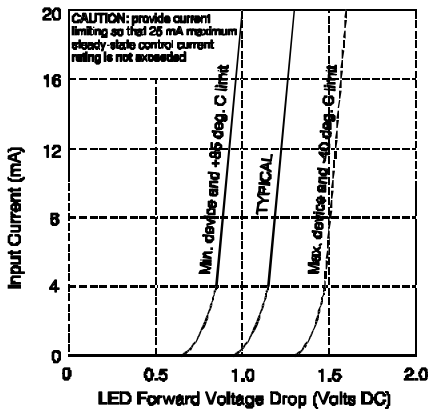

Figure 5. Input Characteristics (Current Controlled)

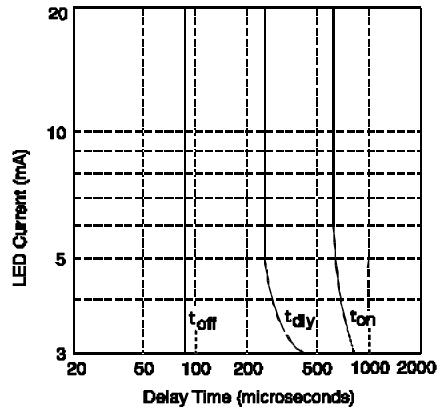

Figure 6. Typical Delay Times

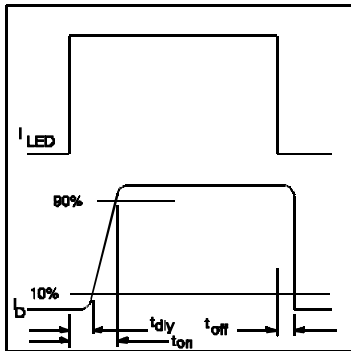

Figure 7. Delay Time Definitions

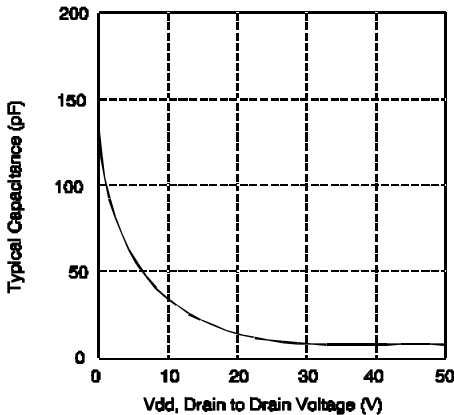
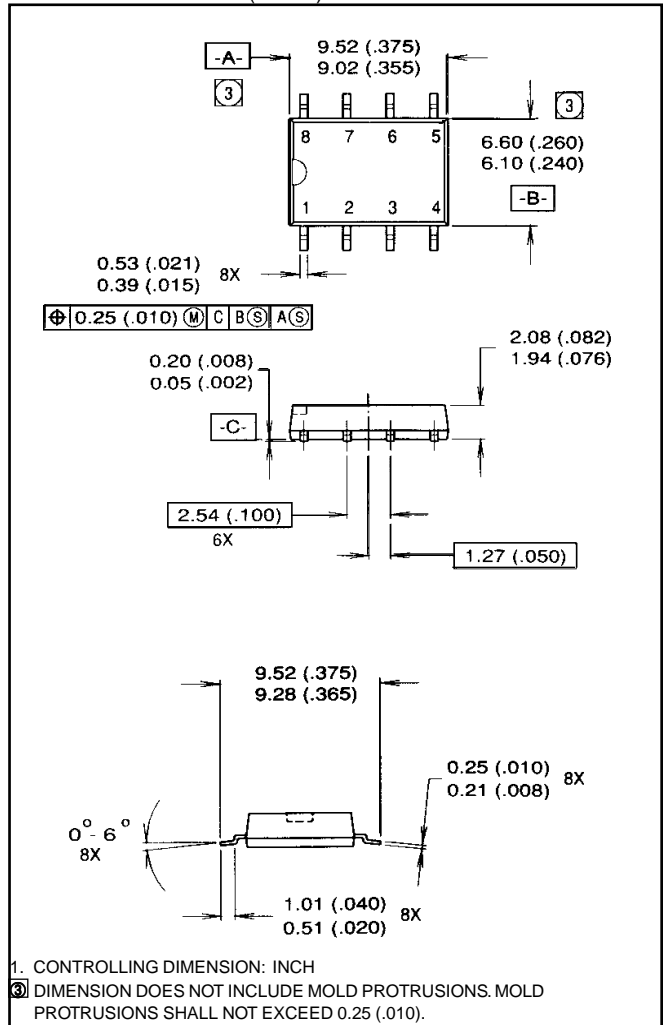

Figure 8. Typical Output Capacitance

**Mechanical Specifications**

Dimensions in millimeters (inches)



**WORLD HEADQUARTERS:** 233 Kansas St., El Segundo, California 90245, Tel: (310) 322 3331  
**EUROPEAN HEADQUARTERS:** Hurst Green, Oxted, Surrey RH8 9BB, UK Tel: ++ 44 1883 713215  
**IR CANADA:** 7321 Victoria Park Ave., Suite 201, Markham, Ontario L3R 2Z8, Tel: (905) 475 1897

**IR GERMANY:** Saalburgstrasse 157, 61350 Bad Homburg Tel: ++ 49 6172 96590

**IR ITALY:** Via Liguria 49, 10071 Borgaro, Torino Tel: ++ 39 11 451 0111

**IR FAR EAST:** 171 (K&H Bldg.), 30-4 Nishi-ikebukuro 3-Chome, Toshima-ku, Tokyo, Japan Tel: ++ 81 3 3983 0641

**IR SOUTHEAST ASIA:** 315 Outram Road, #10-02 Tan Boon Liat Building, Singapore 0316 Tel: ++ 65 221 8371

<http://www.irf.com/>

Data and specifications subject to change without notice. 1/97