



Micro Commercial Components
 21201 Itasca Street Chatsworth
 CA 91311
 Phone: (818) 701-4933
 Fax: (818) 701-4939

MUR3005WT THRU MUR3060WT

30 Amp Super Fast Recovery Rectifier 200 to 600 Volts

Features

- High Surge Capability
- Low Forward Voltage Drop
- High Current Capability
- Super Fast Switching Speed For High Efficiency

Maximum Ratings

- Operating Temperature: -55°C to +150°C
- Storage Temperature: -55°C to +150°C

MCC Part Number	Maximum Recurrent Peak Reverse Voltage	Maximum RMS Voltage	Maximum DC Blocking Voltage
MUR3005WT	50V	35V	50V
MUR3010WT	100V	70V	100V
MUR3020WT	200V	140V	200V
MUR3040WT	400V	280V	400V
MUR3060WT	600V	420V	600V

Electrical Characteristics @ 25°C Unless Otherwise Specified

Average Forward Current	$I_{F(AV)}$	30 A	$T_C = 100^\circ\text{C}$
Peak Forward Surge Current	I_{FSM}	300A	8.3ms, half sine
Maximum Instantaneous Forward Voltage	V_F	1.05V 1.30V 1.70V	$I_{FM} = 15.0\text{A};$ $T_C = 25^\circ\text{C}$
Maximum DC Reverse Current At Rated DC Blocking Voltage	I_R	10 μA 50 μA	$T_C = 25^\circ\text{C}$ $T_C = 125^\circ\text{C}$
Maximum Reverse Recovery Time	T_{rr}	50ns 80ns	$I_F=0.5\text{A}, I_R=1.0\text{A},$ $I_{rr}=0.25\text{A}$

*Pulse Test: Pulse Width 300 μsec , Duty Cycle 1%

TO-247

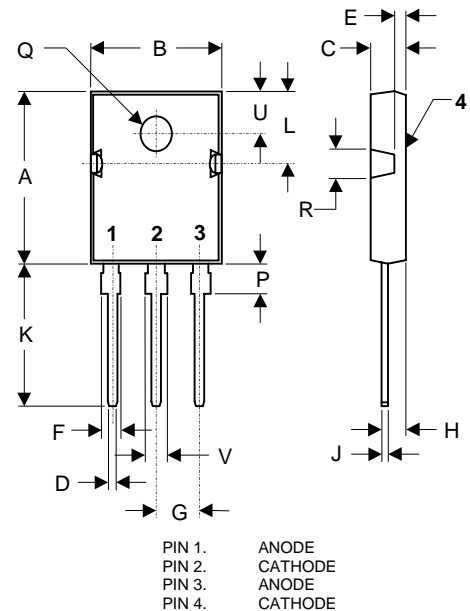

DIM	INCHES		MM		NOTE
	MIN	MAX	MIN	MAX	
A	.803	.823	20.40	20.90	
B	.608	.628	15.44	15.95	
C	.185	.205	4.70	5.21	
D	.043	.051	1.09	1.30	
E	.059	.064	1.50	1.63	
F	.071	.086	1.80	2.18	
G	.215	BSC	5.45	BSC	
H	.101	.130	2.56	2.87	
J	.019	.027	0.48	0.68	
K	.613	.633	15.57	16.08	
L	.286	.295	7.26	7.50	
P	.122	.133	3.10	3.38	
Q	.138	.145	3.50	3.70	∅
R	.130	.150	3.30	3.80	
U	.209	BSC	5.30	BSC	
V	.120	.134	3.05	3.40	

MUR3005WT thru MUR3060WT

Figure 1
Typical Forward Characteristics @ $T_J = 25^\circ\text{C}$

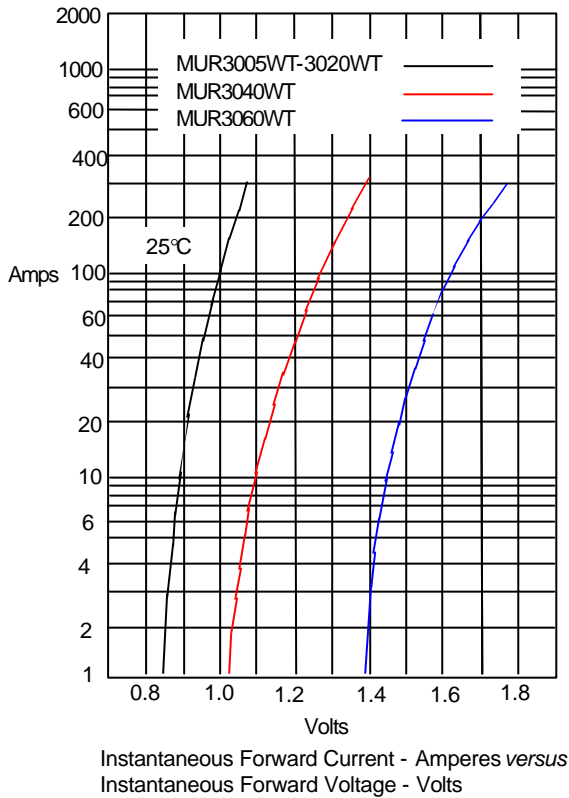

Figure 2
Typical Forward Characteristics @ $T_J = 100^\circ\text{C}$

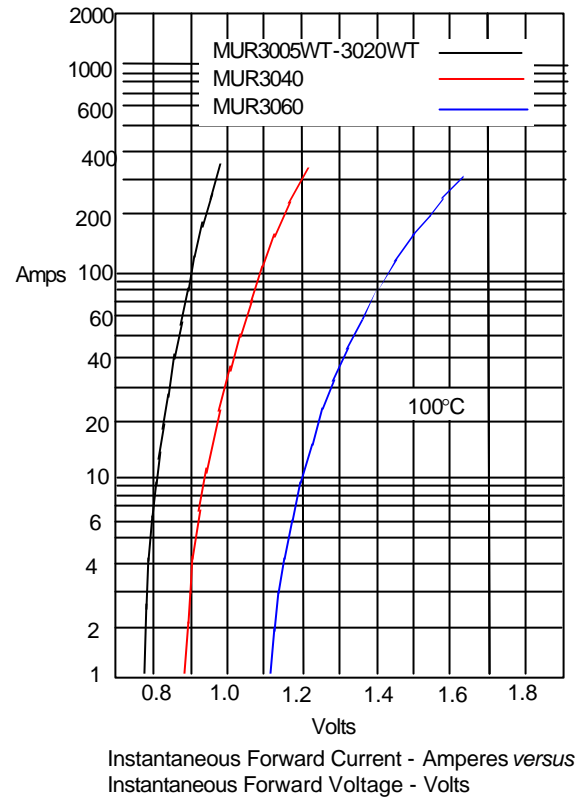
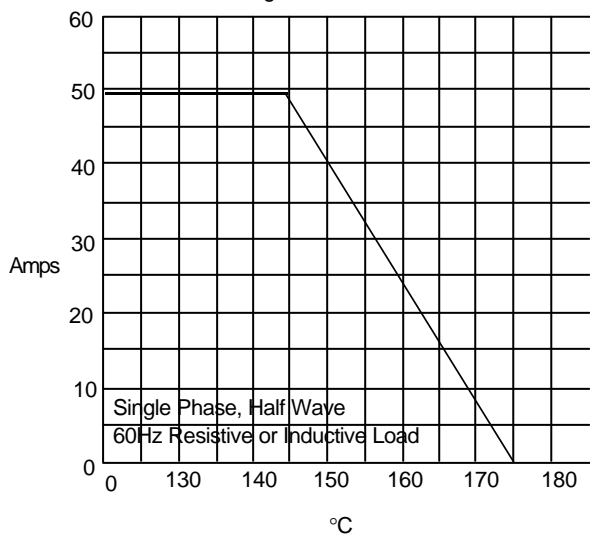

Figure 3
Forward Derating Curve



Average Forward Rectified Current Per Leg - Amperes versus Case Temperature - $^\circ\text{C}$

MUR3005WT thru MUR3060WT

Figure 4
Typical Reverse Characteristics

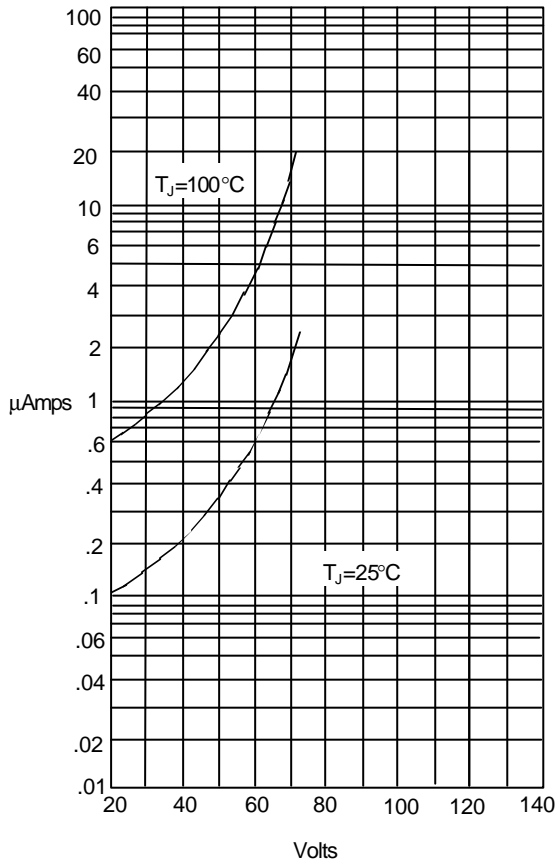

Instantaneous Reverse Leakage Current - MicroAmperes versus

Figure 5
Peak Forward Surge Current

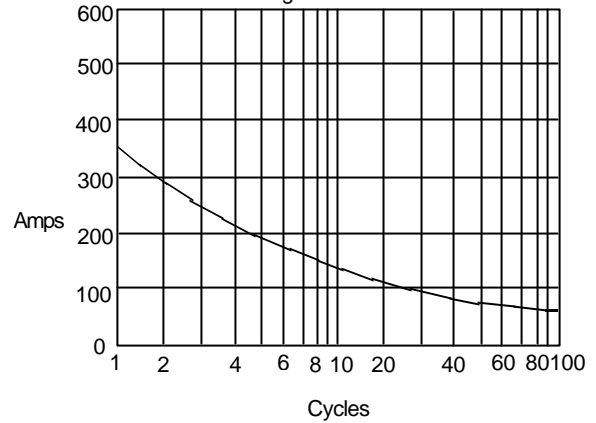

Peak Forward Surge Current - Amperes versus Number Of Cycles At 60Hz - Cycles

Figure 7
Reverse Recovery Time Characteristic And Test Circuit Diagram

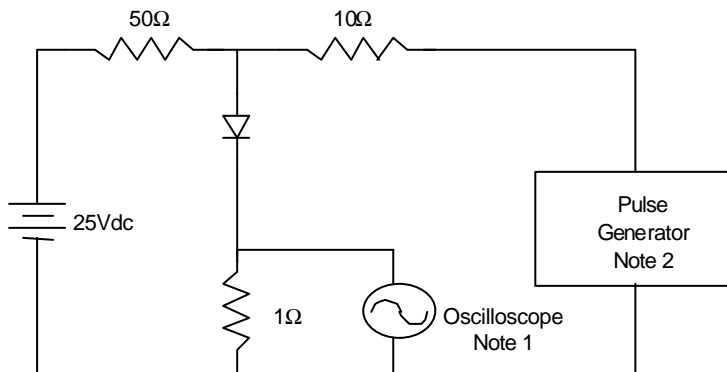

- Notes:
1. Rise Time = 7ns max.
Input impedance = 1 megohm, 22pF
 2. Rise Time = 10ns max.
Source impedance = 50 ohms
 3. Resistors are non-inductive

