

# UTC MC4580 LINEAR INTEGRATED CIRCUIT

## DUAL OPERATIONAL AMPLIFIER

### DESCRIPTION

The UTC MC4580 is the dual operational amplifier, specially designed for improving the tone control, which is most suitable for the audio application.

Featuring noiseless, higher gain bandwidth, high output current and low distortion ratio, and it is most suitable not only for acoustic electronic parts of audio pre-amp and active filter, but also for the industrial measurement tools. It is also suitable for the head phone amp at higher output current, and further more, it can be applied for the handy type set operational amplifier of general purpose in application of low voltage single supply type which is properly biased of the input low voltage source.

### FEATURES

- \*Operating Voltage  $(\pm 2V \text{ to } \pm 18V)$
- \*Low Input Noise Voltage  $(0.8 \mu V_{rms} \text{ typ.})$
- \*Wide Gain Bandwidth Product  $(15MHz \text{ typ.})$
- \*Low Distortion  $(0.0005\% \text{ typ.})$
- \*Slew Rate  $(5V/\mu s \text{ typ.})$
- \*Bipolar Technology

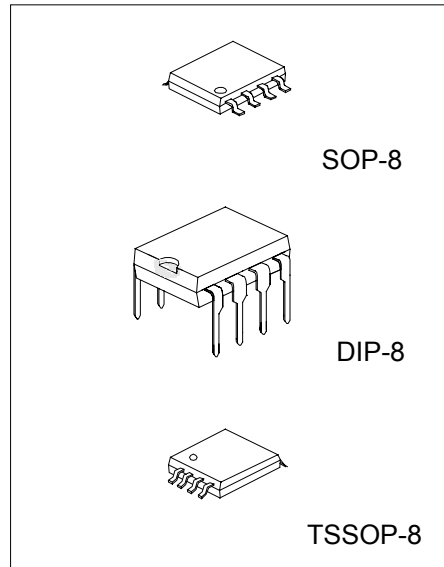

### PIN CONFIGURATION

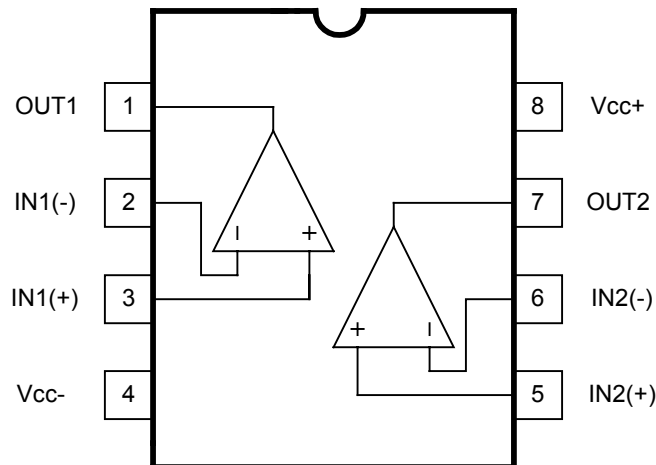

# UTC MC4580 LINEAR INTEGRATED CIRCUIT

## TEST CIRCUIT

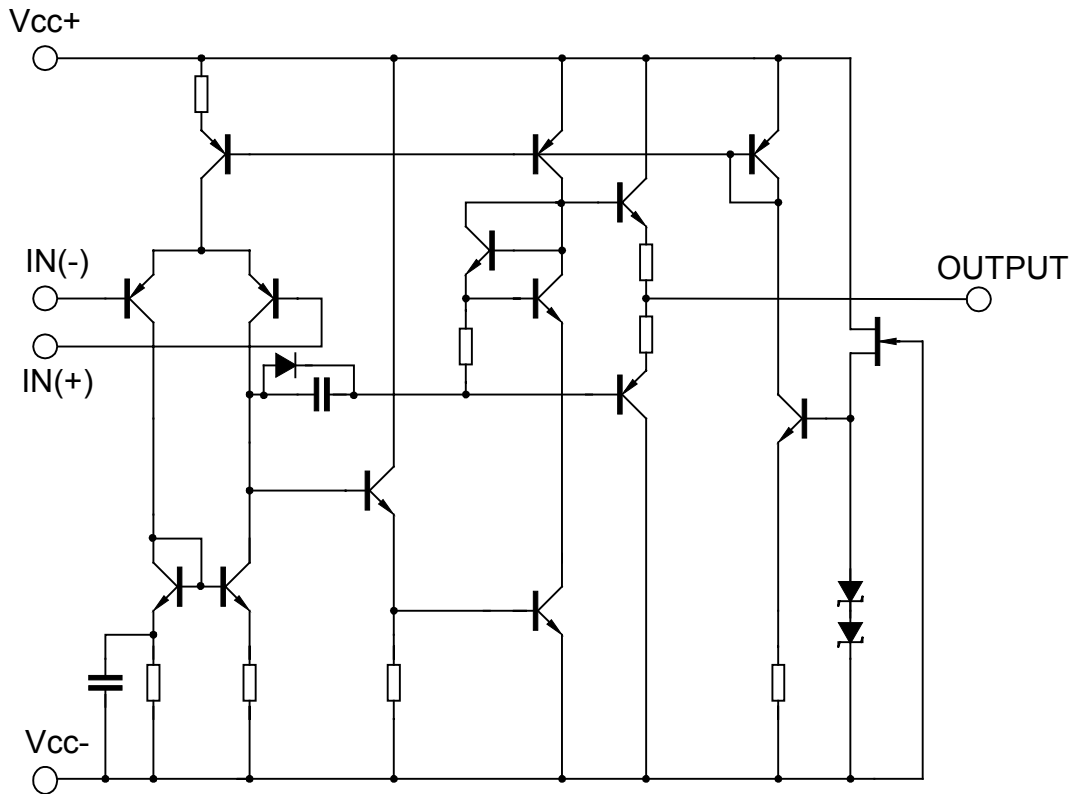

## ABSOLUTE MAXIMUM RATINGS (Ta=25°C)

| PARAMETER                   | SYMBOL      | RATINGS                                     | UNIT |
|-----------------------------|-------------|---|------|
| Supply Voltage              | $V^+ / V^-$ | $\pm 18$                                    | V    |
| Input Voltage               | $V_{IC}$    | $\pm 15$                                    | V    |
| Differential Input Voltage  | $V_{ID}$    | $\pm 30$                                    | V    |
| Output Current              | $I_o$       | $\pm 50$                                    | mA   |
| Power Dissipation           | $P_D$       | 300 (SOP-8)<br>800 (DIP-8)<br>250 (TSSOP-8) | mW   |
| Operating Temperature Range | $T_{opr}$   | -40 to +85                                  | °C   |
| Storage Temperature Range   | $T_{stg}$   | -40 to +125                                 | °C   |

# UTC MC4580 LINEAR INTEGRATED CIRCUIT

## ELECTRICAL CHARACTERISTICS ( $V^+/V^- = \pm 15V$ , $T_a = 25^\circ C$ )

| PARAMETER                       | SYMBOL    | TEST CONDITION  | MIN      | TYP        | MAX | UNIT          |
|---------------------------------|-----------|---|----------|------------|-----|---------------|
| Input Offset Voltage            | $V_{IO}$  | $R_S \leq 10k\Omega$                                      | -        | 0.5        | 3   | mV            |
| Input Offset Current            | $I_{IO}$  |   | -        | 5          | 200 | nA            |
| Input Bias Current              | $I_B$     |   | -        | 100        | 500 | nA            |
| Large Signal Voltage Gain       | $A_V$     | $V_O = \pm 10V$ , $R_L \geq 2k\Omega$                     | 90       | 110        | -   | dB            |
| Output Voltage Swing            | $V_{OM}$  | $R_L \geq 2k\Omega$                                       | $\pm 12$ | $\pm 13.5$ | -   | V             |
| Input Common Mode Voltage Range | $V_{ICM}$ |   | $\pm 12$ | $\pm 13.5$ | -   | V             |
| Common Mode Rejection Ratio     | CMR       | $R_S \leq 10k\Omega$                                      | 80       | 110        | -   | dB            |
| Supply Voltage Rejection Ratio  | SVR       | $R_S \leq 10k\Omega$                                      | 80       | 110        | -   | dB            |
| Operating Current               | $I_{CC}$  |   | -        | 6          | 9   | mA            |
| Slew Rate                       | SR        | $R_L \geq 2k\Omega$                                       | -        | 5          | -   | V/ $\mu s$    |
| Gain bandwidth Product          | GB        | $f = 10KHz$   | -        | 15         | -   | MHz           |
| Total Harmonic Distortion       | THD       | $A_V = 20dB$ , $V_O = 5V$ , $R_L = 2k\Omega$ , $f = 1KHz$ | -        | 0.0005     | -   | %             |
| Input Noise Voltage             | $V_{NI}$  | RIAA $R_S = 2.2k\Omega$ , 30kHz LPF                       | -        | 0.8        | -   | $\mu V_{rms}$ |

## TYPICAL CHARACTERISTICS

Maximum Output Voltage Swing vs. Load Resistance

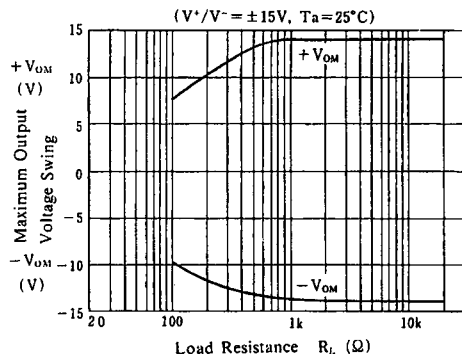

Maximum Output Voltage Swing vs. Frequency

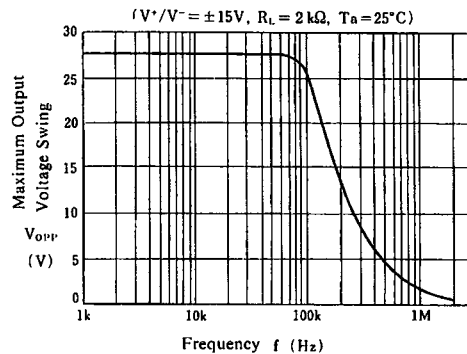

Output Voltage Swing vs. Output Current

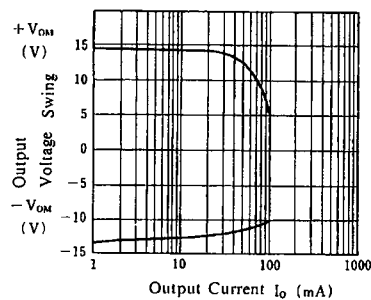

Equivalent Input Noise Voltage vs. Frequency

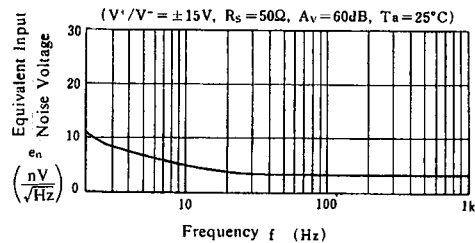

# UTC MC4580 LINEAR INTEGRATED CIRCUIT

Operating Current vs. Temperature

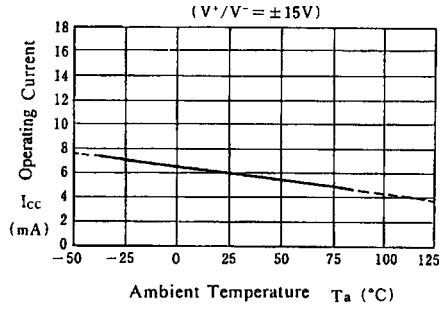

Output Voltage Swing vs. Temperature

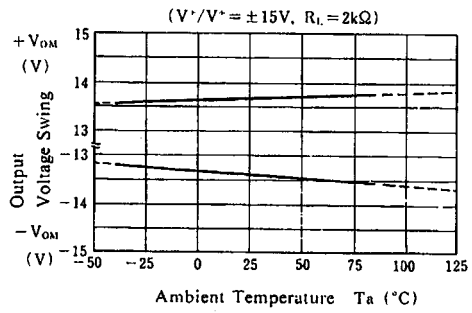

Input Offset Voltage vs. Temperature

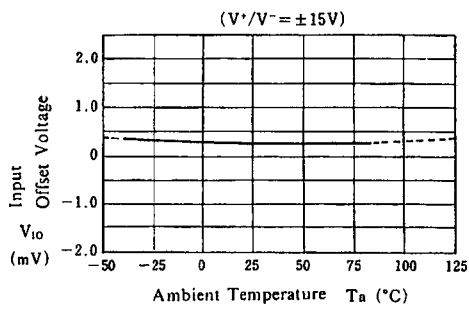

Input Bias Current vs. Temperature

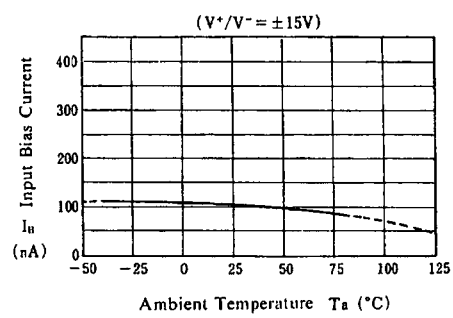

Maximum Output Voltage Swing vs. Operating Voltage

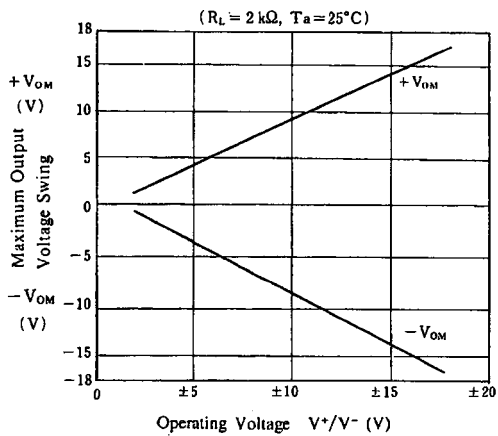

Operating Current vs. Operating Voltage

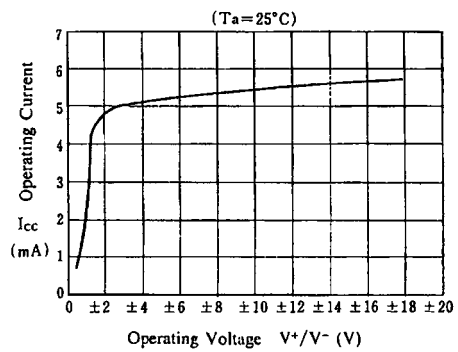

# UTC MC4580 LINEAR INTEGRATED CIRCUIT

Total Harmonic Distortion vs. Output Voltage

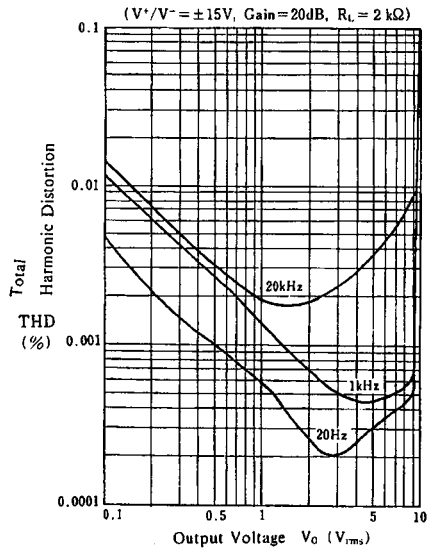

Voltage Gain, Phase vs. Frequency

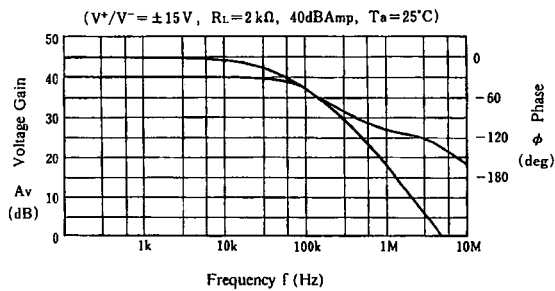

UTC assumes no responsibility for equipment failures that result from using products at values that exceed, even momentarily, rated values (such as maximum ratings, operating condition ranges, or other parameters) listed in products specifications of any and all UTC products described or contained herein. UTC products are not designed for use in life support appliances, devices or systems where malfunction of these products can be reasonably expected to result in personal injury. Reproduction in whole or in part is prohibited without the prior written consent of the copyright owner. The information presented in this document does not form part of any quotation or contract, is believed to be accurate and reliable and may be changed without notice.