

Technical Data

MC44BC373C/D
Rev. 3.1 7/2002

MC44BC373C/374C
PLL Tuned UHF and
VHF Audio/Video High
Integration Modulator



MC44BC373C/374C

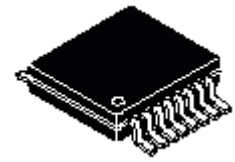
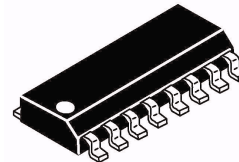

SO16NB Package TSSOP16 Package

Ordering Information

Device	Temp Range	Package
MC44BC373CD,R2	-20°C to +85°C	SO16NB
MC44BC374CD,R2	-20°C to +85°C	SO16NB
MC44BC373CDTB,R2	-20°C to +85°C	TSSOP16
MC44BC374CDTB,R2	-20°C to +85°C	TSSOP16

NOTE: For tape and reel, add R2 suffix.

Freescale Semiconductor, Inc.

Contents List

1 Features 2
 2 Device Overview 3
 3 Maximum Ratings 4
 4 Thermal Rating 4
 5 Electrostatic Discharge 4
 6 Electrical Characteristics 5
 7 I2C Bit Mapping 6
 8 I2C Programming 7
 9 Modulator High Frequency Characteristics 9
 10 Video Characteristics . 10
 11 Audio Characteristics . 11
 12 Characterization Measurement Conditions 12
 13 Modulator Description 17
 14 High Speed I2C Compatible Bus 21
 15 Pin Circuit Schematics 24
 16 Application and Case Diagrams 25

The modulators are for use in VCRs, set-top boxes, and similar devices.

Figure 1 shows the pin connections.

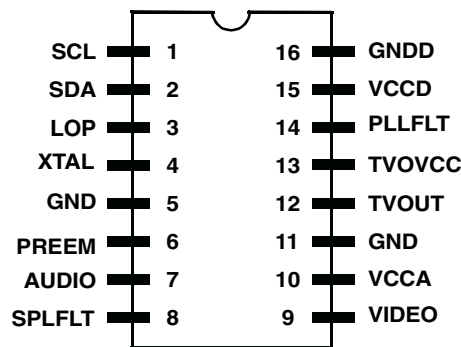

Figure 1. MC44BC373C/4C Pin Connections

This document contains information on a product under development. Motorola reserves the right to change or discontinue this product without notice. © Motorola, Inc., 2002. All rights reserved.

1 Features

MC44BC373C: Multi-Standard PAL/SECAM/NTSC Modulator

MC44BC374C: PAL/NTSC only Modulator

The channel is set by an on-chip high-speed I²C compatible bus receiver. A Phase-Locked Loop (PLL) tunes the modulator over the full UHF range.

The modulator incorporates a sound subcarrier oscillator and uses a second PLL to derive 4.5, 5.5, 6.0, and 6.5 MHz subcarrier frequencies. These frequencies are selectable using the bus.

The modulation standard can be chosen using a control bit that selects between System L or System B/G (MC44BC373C only).

The picture-to-sound ratio may be adjusted using the bus. In addition, an on-chip video test pattern generator can be switched ON with a 1 KHz audio test signal.

The MC44BC373C/4C also has the following features:

- No external varicaps diodes/inductor or tuned components
- Channel 21-69 UHF operation
- VHF range possible by internal dividers (30MHz–450MHz)
- Integrated on-chip programmable UHF oscillator
- Extremely low external components count
- High speed read and write I²C-bus compatible (800kHz)
- Fixed video modulation depth (80% in PAL and 90% in SECAM)
- Peak White Clip disabled via the bus
- Programmable picture/sound carrier ratio (12dB and 16dB)
- Integrated on-chip programmable sound subcarrier oscillator (4.5MHz to 6.5MHz)—No external varicaps
- On-chip video test pattern generator with sound test signal (1kHz)
- Low-power programmable modulator standby mode
- Transient output inhibit during PLL Lock-up at power-ON
- Logical Output Port controlled by bus
- Custom masked versions with unique start-up settings possible (no I²C bus programming required)
- Extremely robust ESD protection, minimum 4kV, typical 6kV

2 Device Overview

Figure 2 shows a simplified block diagram of the MC44BC373C/4C device.

The MC44BC373C/4C device has three main sections:

1. A high speed I²C-compatible bus section
2. A PLL section to synthesize the UHF/VHF output channel frequency (from an integrated UHF oscillator, divided for VHF output)
3. A modulator section, which accepts audio and video inputs, then uses them to modulate the UHF/VHF carrier

An on-chip video test pattern generator with an audio test signal is included.

The MC44BC373C operates as a multi-standard modulator and can handle the following systems using the same external circuit components: B/G, I, D/K, L, M/N.

High frequency BiCMOS technology allows integration of the UHF tank circuit and certain filtering functions.

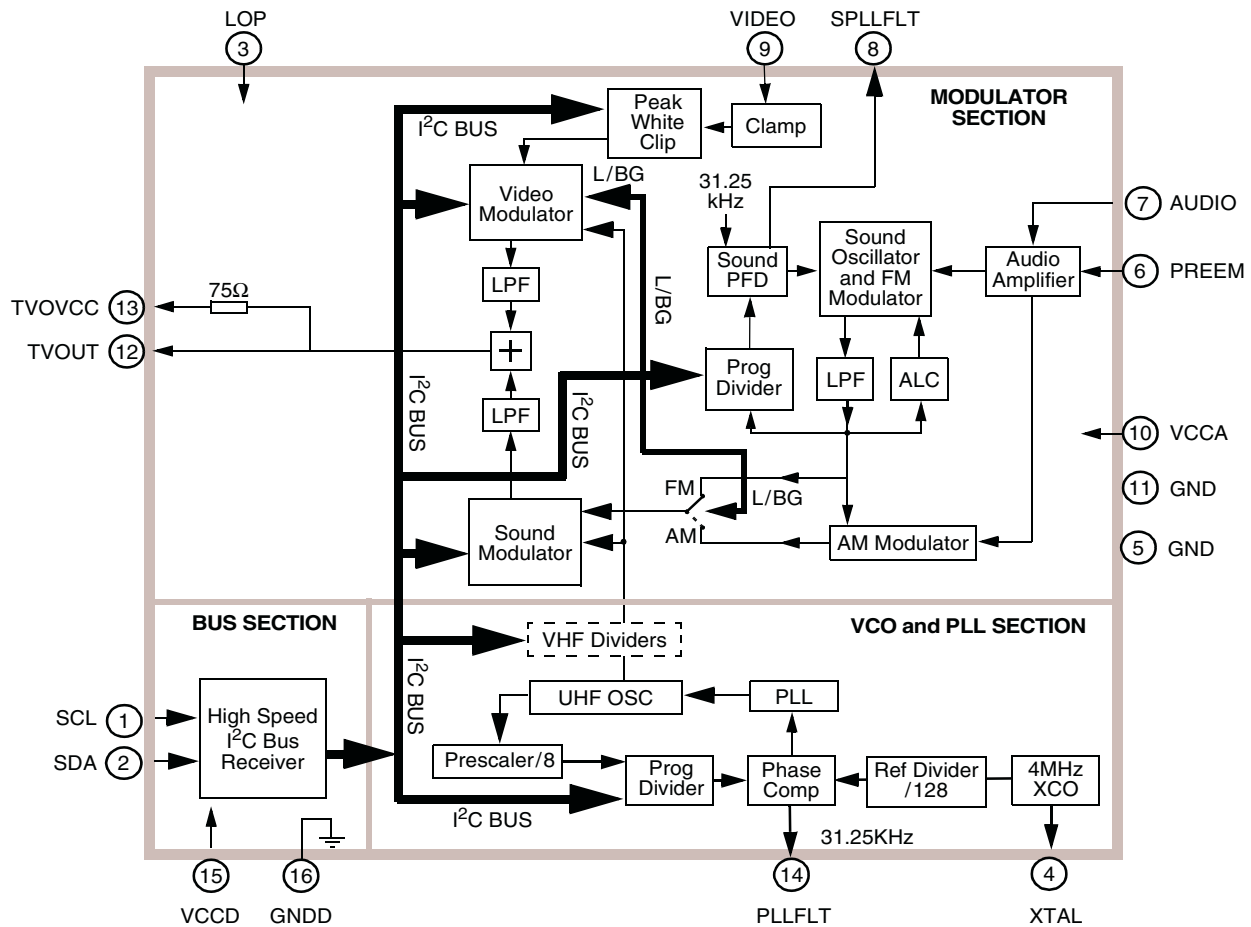

Figure 2. MC44BC373C/4C Simplified Block Diagram

3 Maximum Ratings

Sym	Parameter	Value	Unit
Vcc	Supply voltage	6	V
Tamin	Minimum operating ambient temperature	-20	°C
Tamax	Maximum operating ambient temperature	85	°C
Tstgmin	Minimum storage temperature	-65	°C
Tstgmax	Maximum storage temperature	150	°C
Tj	Junction Temperature	150	°C

This device contains protection circuitry to guard against damage due to high static voltage or electric fields. However, precautions must be taken to avoid applications of any voltage higher than maximum rated voltages to this high impedance circuit. For proper operation, input and output voltages should be constrained to the ranges indicated in the Recommended Operating Conditions.

Maximum ratings are those values beyond which damage to the device may occur. For functional operation, values should be restricted to the Recommended Operating Condition.

Meets Moisture Sensitivity Level 1, no dry pack required

4 Thermal Rating

Sym	Parameter	Value	Unit
R _{thja}	Thermal resistance from Junction to Ambient	140	°C/W

5 Electrostatic Discharge

Electrostatic Discharge (ESD) tests are done on all pins.

Sym	Parameter	Min	Typ	Unit
ESD	MM (Machine Model) - MIL STD 883C method 3015-7	200	500	V
ESD	HBM (Human Body Model) - MIL STD 883C method 3015-7	4000	6000	V

6 Electrical Characteristics

- A = 100% tested
- B = 100% Correlation tested
- C = Characterized on samples
- D = Design parameter

See Characterization conditions section for each “C” type parameter

6.1 Specification Conditions

Unless otherwise stated: $V_{CC}=5.0V$, Ambient Temperture= $25^{\circ}C$, Video Input $1V_{p-p}$, 10-step grayscale. RF output into 75Ohm load. SPECIFICATIONS ONLY VALID FOR ENVELOPE DEMODULATION.

Parameter	Min	Typ	Max	Unit	Notes	Type
Operating supply voltage range	4.5	5.0	5.5	V		B
Total supply current	44	52	60	mA	All sections active	A
Total standby mode supply current	3	6	9	mA	OSC, SO, ATT=1 Bus Section active	A
Test pattern sync pulse width	3	4.7	6.5	μS		B
Sound comparator charge pump current						
During locking	7	10	12	μA		A
When locked	0.7	1	1.5	μA		A
RF comparator charge pump current	60	100	150	μA		A
Crystal oscillator stability—negative resistance	1	—	—	K Ω		D
Logic Output Port						
Saturation voltage at $I=2mA$	—	160	300	mV		A
Leakage current	—	—	1	μA		A

7 I²C Bit Mapping

WRITE MODE	Bit 7	Bit 6	Bit 5	Bit 4	Bit 3	Bit 2	Bit 1	Bit 0	ACK
CA—CHIP ADDRESS	1	1	0	0	1	0	1	0	ACK
C1—High Order Bits	1	0	SO	LOP	PS	X3	X2	SYSL	ACK
C0—Low Order Bits	PWC	OSC	ATT	SFD1	SFD0	TB1	X5	X4	ACK
FM—High Order Bits	0	TPEN	N11	N10	N9	N8	N7	N6	ACK
FL—Low Order Bits	N5	N4	N3	N2	N1	N0	X1	X0	ACK
READ MODE	Bit 7	Bit 6	Bit 5	Bit 4	Bit 3	Bit 2	Bit 1	Bit 0	ACK
CHIP ADDRESS	1	1	0	0	1	0	1	1	ACK
R—Status Byte	—	—	—	—	—	Y2	Y1	OOR	-

Bit Name	Description
PWC	Peak White Clip enable/disable
OSC	UHF oscillator ON/OFF
ATT	Modulator output attenuated—sound and video modulators ON/OFF
SFD0, 1	Sound subcarrier frequency control bits
TB1	Test mode bit—bus format compatible with MC44353
SO	Sound Oscillator ON/OFF
LOP	Logic Output Port
PS	Picture-to-sound carrier ratio
SYSL	System L enable—selects AM sound and positive video modulation (MC44BC373C only)
TPEN	Test pattern enable—picture and sound
X5...X0	Test mode bits—All bits are 0 for normal operation (see Test Mode tables, page 6 & page 7)
N0...N11	UHF frequency programming bits, in steps of 250kHz
OOR	RF oscillator out-of-frequency range information
Y1, Y2	RF oscillator operating range information

8 I²C Programming

Sound

SFD1	SFD0	Sound Subcarrier Freq (MHz)
0	0	4.5
0	1	5.5
1	0	6.0
1	1	6.5
PS	Picture-to-Sound Ratio (dB)	
0	12	
1	16	
SO	Sound Oscillator	
0	Sound oscillator ON (Normal mode)	
1	Sound oscillation disabled (oscillator and PLL section bias turned OFF)	

Video

SYSL	System L/BG Selection (MC44BC373C only)
0	System B/G enabled, System L disabled (FM sound and negative video modulation)
1	System L enabled, System B/G disabled (AM sound and positive video modulation)
PWC	Peak White Clip
0	Peak White Clip ON (System B/G)
1	Peak White Clip OFF (System L)
TPEN	Test Pattern Signal
0	Test pattern signal OFF (normal operation)

WRITE MODE: Test Mode 1 and VHF Range

X2	X1	X0	State	Description
0	0	0	1.a	Normal operation
0	0	1	1.b	RF frequency divided for low frequency testing or VHF range: RF/2
0	1	0	1.c	RF/4
0	1	1	1.d	RF/8
1	0	0	1.e	RF/16
1	0	1	1.f	DC drive applied to modulators: Non-inverted video at TVOUT
1	1	0	1.g	DC drive applied to modulators: Inverted video at TVOUT
1	1	1	1.h	Transient output inhibit disabled (ie speed up mode) During this speed-up test mode, ATT=0 forces sound current source to 1μA, and ATT=1 forces it to 10μA.

UHF

OSC	UHF Oscillator
0	Normal operation
1	UHF oscillator disabled (oscillator and PLL sections bias turned OFF)
ATT	Modulator Output Attenuation
0	Normal operation
1	Modulator output attenuation (sound and video modulators sections bias turned OFF).

Standby Mode

OSC	SO	ATT	Combination of 3-bits
1	1	1	Modulator standby mode

MC44353/4/5 Compatibility

TB1	Description
0	Normal mode (Full programmability)
1	Limited programmability and compatibility with MC44353

Logic Output Port

LOP	Description
0	Pin 3 is low voltage
1	Pin 3 is high impedance

WRITE MODE: Test Mode 2

X5	X4	X3	State	Description
0	0	0	2.a	Normal operation
0	0	1	2.b	Test pattern generator DC verification (Test pattern DC test mode available)
0	1	0	2.c	Program divider test (UHF program divider on PLLFILT pin and sound program divider on SPLLFIL pin)
0	1	1	2.d	Reference divider test (UHF reference divider on PLLFILT pin)
1	0	0	2.e	UHF phase comparison, upper source on PLLFILT pin Sound phase comparison 10 μ A upper source on SPLLFIL (Only valid during transient output inhibit.)
1	0	1	2.f	UHF phase comparison, lower source on PLLFILT pin Sound phase comparison 10 μ A lower source on SPLLFIL (Only valid during transient output inhibit.)
1	1	0	2.g	Sound phase comparison 1 μ A upper source on SPLLFIL (Not valid during transient output inhibit.)
1	1	1	2.h	Sound phase comparison 1 μ A lower source on SPLLFIL (Not valid during transient output inhibit.)

NOTE:

Test modes 1 and 2 are intended for manufacturing test purposes only and cannot be used for normal applications, except for VHF range (states 1.b to 1.e)

READ MODE

OOR	Description
0	Normal operation, VCO in range
1	VCO out of range
Y1	Description
0	VCO out of range, frequency too low, only valid if OOR=1
1	VCO out of range, frequency too high, only valid if OOR=1
Y2	Description
0	High VCO is active
1	Low VCO is active

9 Modulator High Frequency Characteristics

Unless otherwise stated: $V_{cc}=5.0V$, Ambient Temperature= $25^{\circ}C$, Video Input $1V_{p-p}$, 10-step grayscale. RF inputs/outputs into 75 Ohm load. SPECIFICATIONS ONLY VALID FOR ENVELOPE DEMODULATION.

Parameter	Test Conditions	Min	Typ	Max	Unit	Type
TVOUT output level	Output signal from modulator section See Figure 3. See Note 2	73	74.5	77	dB μ V	B
UHF oscillator frequency		460	—	880	MHz	A
VHF range	From UHF oscillator internally divided	45	—	460	MHz	B
TVOUT output attenuation	During transient output inhibit, or when ATT bit is set to 1. See Figure 3. See Note 2	50	60	—	dBc	B
Sound subcarrier harmonics (F_{p+n*Fs})	Reference picture carrier. See Note 2	—	63	58	dBc	C
Second harmonic of chroma subcarrier	Using red EBU bar. See Note 2	—	—	65	dBc	C
Chroma/Sound intermodulation: $F_{p+} (F_{snd} - F_{chr})$	Using red EBU bar. See Note 2	—	—	65	dBc	C
F_o (picture carrier) harmonics	2nd harmonic: CH21 3rd harmonic: CH21 Other channels: See Figure 3. See NOTE 1. See Note 2	— —	35 26	30 22	dBc	C
Out band (picture carrier) spurious	$1/2*F_o - 1/4*F_o - 3/2*F_o - 3/4*F_o$ From 40MHz to 1GHz. See Note 2	—	0	10	dB μ V	C
In band spurious ($F_o \pm 5MHz$)	No video sound modulation. See Note 2	—	—	60	dBc	C

Note: 1: Picture carrier harmonics are highly dependant on PCB layout and decoupling capacitors.
Note: 2: See "Characterization Measurement Conditions" on page 12.

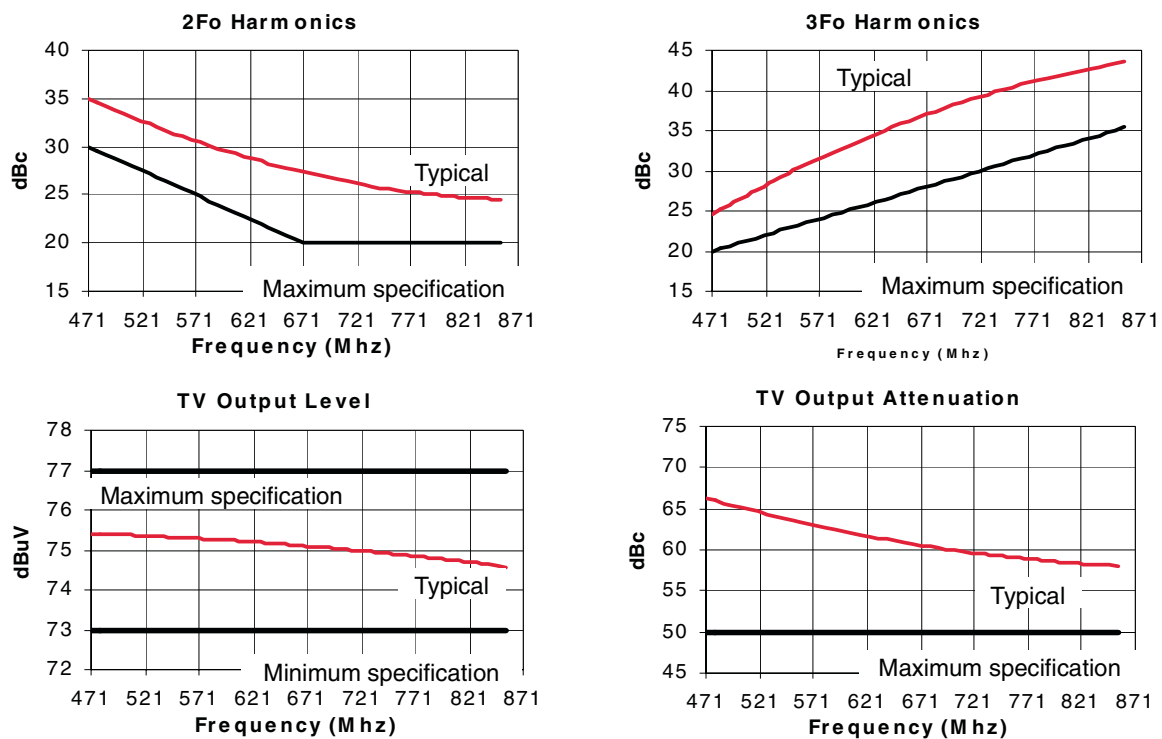

Figure 3. Typical Performance

10 Video Characteristics

Unless otherwise stated: $V_{cc}=5.0V$, Ambient Temperature= $25^{\circ}C$, Video Input $1V_{p-p}$, 10-step grayscale. RF output into 75Ohm load. SPECIFICATIONS ONLY VALID FOR ENVELOPE DEMODULATION.

Parameter	Test Conditions	Min	Typ	Max	Unit	Type
Video bandwidth	Reference 0dB at 100kHz, measured at 5MHz. See Note 2	-1.5	-0.8	—	dB	C
Video input level	75Ohm load	—	—	1.5	Vcvbs	D
Video input current		—	0.2	1	μA	A
Video input impedance		500	—	—	K Ω	A
Peak White Clip	PWC bit set to 1, see PWC section. See Note 2	110	114	118	%	A
Video S/N	No sound modulation, 100% white video					
	Using CCIR Rec.567 weighting filter See Figure 4. See Note 2	50	53	—	dB	C
	Unweighted. See Note 2	45	—	—		C
Differential Phase	CCIR Test Line 330, worst case from the first 4 steps out of 5. See Note 2	-5	—	5	deg	C
Differential Gain	CCIR Test Line 330, worst case from the first 4 steps out of 5. See Note 2	-5	—	5	%	C
Luma/Sync ratio	Input ratio 7.0:3.0	6.8/ 3.2	—	7.2/ 2.8	—	B
PAL video modulation depth	See Figure 4. See Note 2	75	81	88	%	B
SECAM video modulation depth	MC44BC373C only - See Figure 4. See Note 2	88	93	99	%	B

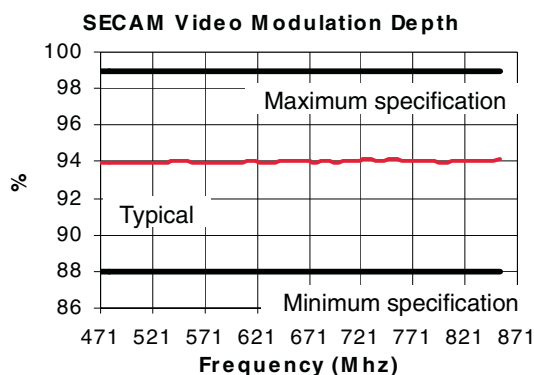
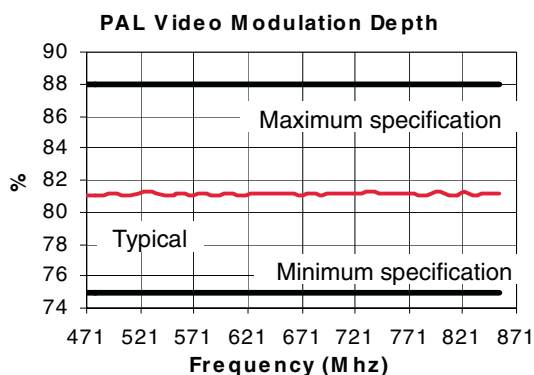
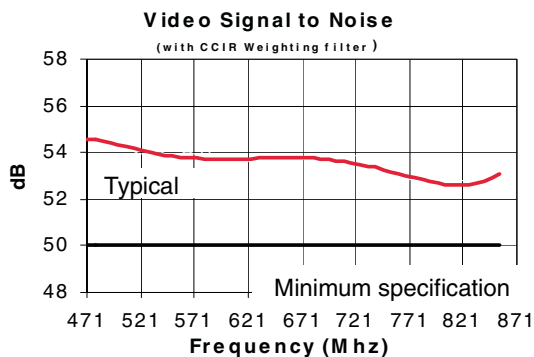

Figure 4. Typical Performances

11 Audio Characteristics

Unless otherwise stated: $V_{cc}=5.0V$, Ambient Temperature= $25^{\circ}C$, Video Input $1V_{p-p}$, 10-step grayscale. RF inputs/outputs into 75 Ohm load. SPECIFICATIONS ONLY VALID FOR ENVELOPE DEMODULATION.

Parameter	Test Conditions	Min	Typ	Max	Unit	Type
Picture-to-Sound ratio	PS bit set to 0 PS bit set to 1	13 9	16 12	19 15	dB	B
Audio modulation depth	Using specific pre-emphasis circuit, audio input level= $205mV_{rms}$ —audio frequency= $1kHz$					
	AM modulation: SECAM $F_s=6.5MHz$	—	80	—	%	B
	FM modulation: $F_s=5.5, 6$ or $6.5MHz$ 100% modulation= $\pm 50kHz$ FM deviation	—	80	—	%	B
	FM modulation: NTSC $F_s=4.5MHz$ 100% modulation= $\pm 25kHz$ FM deviation	—	80	—	%	B
Audio input resistance		45	53	61	K Ω	A
Audio Frequency response	Reference 0dB at 1 kHz, using specified pre-emphasis circuit, measure from 50Hz to 15kHz	-2.5	—	+2	dB	C
Audio Distortion FM (THD only)	at 1 kHz, 100% modulation ($\pm 50kHz$) No video	—	0.4	2	%	C
Audio Distortion AM (THD only)	at 1 kHz, 100% modulation No video	—	1.5	2.5	%	D
Audio S/N with Sync Buzz FM	Ref 1Khz, 50% modulation ($\pm 25Khz$) EBU color bars Video signal, using CCIR 468.2 weighting filter	48	53	—	dB	C
Audio S/N with Sync Buzz AM	Reference 1 kHz, 85% modulation Video input EBU color bar 75% Audio BW 40Hz—15kHz Weighting filter CCIR 468-2	45	50	—	dB	D

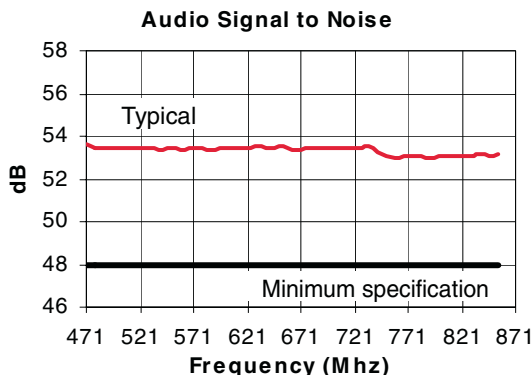

Figure 5. Typical Performances

12 Characterization Measurement Conditions

Device default configuration unless otherwise specified:

- Peak White Clip enable
- UHF oscillator ON
- Sound and video modulators ON
- Sound subcarrier frequency = 5.5Mhz
- TB1 bit set to '0' (bus format not compatible with MC44353)
- Sound Oscillator ON
- Logic Output Port LOW
- Picture-to-sound carrier ratio = 12dB
- System L disabled
- Test pattern disabled
- All test mode bits are '0'
- Frequency from channel 21 to 69

RF Inputs / Output into 75ohm Load using a 75 to 50 ohm transformation. Video Input 1V pk-pk. Audio pre-emphasis circuit engaged.

Device and Signals Set-up	Measurement Set-up
TVOUT output level	
Video: 10 steps grey scale No audio	Measured picture carrier in dBuV with the HP8596E Spectrum Analyzer using a 75 to 50 ohm transformation, all cables losses and transformation pads having been calibrated. Measurement used as a reference for other tests: TVout_Ref
TVOUT output attenuation	
"ATT" bit = 1 No Video signal No Audio signal	Measure in dBc picture carrier at "ATT"="1" with reference to picture carrier at "ATT"="0".
Sound Subcarrier Harmonics	
Video: 10 steps grey scale No Audio signal	Measure in dBc second and third sound harmonics levels in reference to picture carrier (TVout_Ref). <div style="text-align: center;"> <p>The diagram shows a spectrum with four peaks. The first peak is labeled 'Picture carrier' and is at frequency 'Fo'. The second peak is labeled 'Sound carrier' and is at frequency '+5.5Mhz'. The third peak is labeled 'Sound 2nd harm' and is at frequency '+11Mhz'. The fourth peak is labeled 'Sound 3rd harm' and is at frequency '+16.5Mhz'. Vertical arrows indicate the relative levels of the sound harmonics compared to the picture carrier.</p> </div>

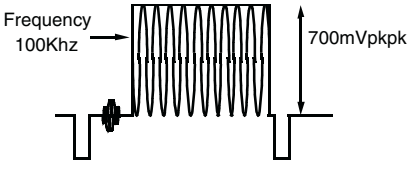
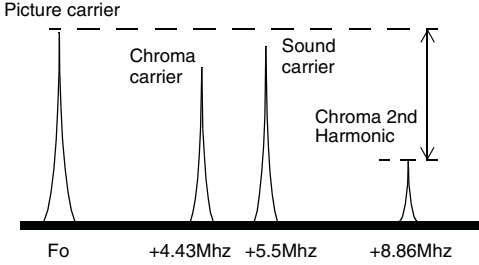
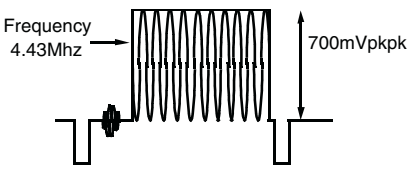
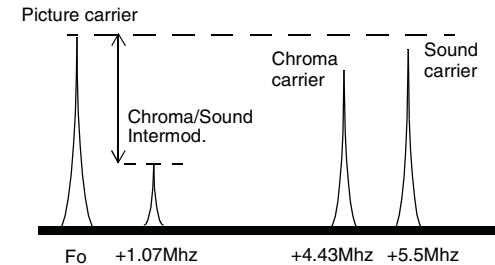
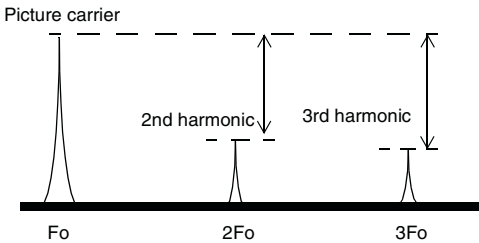
Device and Signals Set-up	Measurement Set-up
Second Harmonics of Chroma subcarrier	
<p>No audio Video: a 700mVpk-pk 100Khz sinusoidal signal is inserted on the black level of active video area.</p>  <p>Frequency 100Khz 700mVpkpk</p>	<p>Measure in dBc, in reference to picture carrier (TVout_Ref), second harmonic of chroma at channel frequency plus 2 times chroma frequency, resulting in the following spectrum</p>  <p>Picture carrier Chroma carrier Sound carrier Chroma 2nd Harmonic</p> <p>Fo +4.43Mhz +5.5Mhz +8.86Mhz</p>
Chroma/Sound intermodulation	
<p>No audio signal Video: 700mVpk-pk 100Khz sinusoidal signal inserted on the black level of active video area. This is generated using a Rohde & Schwarz Video Generator SAF and inserting the required frequency from a RF Signal generator.</p>  <p>Frequency 4.43Mhz 700mVpkpk</p>	<p>Measure in dBc, in reference to picture carrier (TVout_Ref), intermodulation product at channel frequency plus the sound carrier frequency (+5,5Mhz) minus the chroma frequency (-4,43Mhz), resulting in the following spectrum. Intermodulation product is at the channel frequency +1,07Mhz.</p>  <p>Picture carrier Chroma/Sound Intermod. Chroma carrier Sound carrier</p> <p>Fo +1.07Mhz +4.43Mhz +5.5Mhz</p>
Picture Carrier Harmonics	
<p>No Video signal No Audio signal</p>	<p>Measure in dBc, in reference to picture carrier (TVout_Ref), second and third harmonic of channel frequency, resulting in the following spectrum.</p>  <p>Picture carrier 2nd harmonic 3rd harmonic</p> <p>Fo 2Fo 3Fo</p>

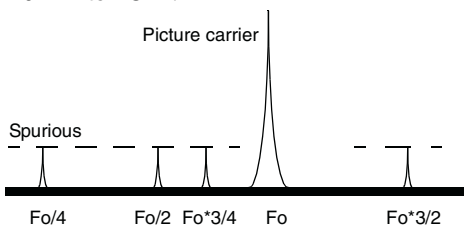
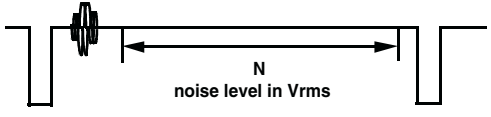
Device and Signals Set-up	Measurement Set-up
Out of Band Spurious	
No Video signal No Audio signal	Measure in dBuV spurious levels at 0.25, 0.5, 0.75 and 1.5 times channel frequency, resulting in the following spectrum Measure from 40Mhz to 1Ghz. 
In Band Spurious	
No Video signal No Audio signal	Measure in dBc, in reference to picture carrier (TVout_Ref), spurious levels falling into video bandwidth Fo+/-5Mhz.
Video Bandwidth	
No audio Video: 600mVpk-pk sinusoidal signal inserted on the black level of active video area.	The Video signal is demodulated on the spectrum analyzer, and the peak level of the 100Khz signal is measured as a reference. The frequency is then swept from 100Khz to 5Mhz, and then the difference in dBc from the 100Khz reference level is measured.
Peak White Clip	
No Audio signal. Video: 10 step grey scale	The video modulation depth is measured for 1.0VCVBS input level, giving modulation depth MDA. Then the same measurement is carried out for an input level of 1.4VCVBC, giving modulation depth MDB. The Peak White Clip is defined as 100*MDB/MDA.
Weighted Video Signal to Noise	
Video: 100% White video signal - 1Vpk-pk. No Audio signal This is measured using a Rohde & Schwarz AMFS UHF Demodulator in B/G (using a CCIR Rec. 567 weighting network, 100kHz to 5MHz band with sound trap and envelope detection, and a Rohde & Schwarz UAF Video Analyzer.	The Video Analyzer measures the ratio between the amplitude of the active area of the video signal (700mV) and the noise level in Vrms on a video black level which is show below. VideoS/N is calculated as $20 \times \log(700 / N)$ in dB 
Unweighted Video Signal to Noise	
Same as above with CCIR filter disabled.	Same as above.
Video Differential Phase	
Video: 5 step Grey Scale- 1Vpk-pk. No Audio signal This is measured using a Rohde & Schwarz AMFS UHF Demodulator in B/G (using a CCIR Rec. 567 weighting network, 100kHz to 5MHz band with sound trap, and envelope detection, and a Rohde & Schwarz UAF Video Analyzer.	On line CCIR 330, the video analyzer DP measure consists of calculating the difference of the Chroma phase at the black level and the different chroma subcarrier phase angles at each step of the greyscale. The largest positive or negative difference indicates the distortion. $\text{DIFF PHASE} = \frac{\text{the largest positive or negative difference}}{\text{the phase at position 0}} * 100\%$ <p>The video analyzer method takes the worst step from the first 4 steps.</p>

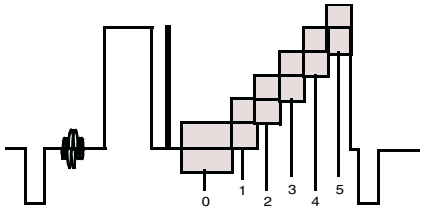
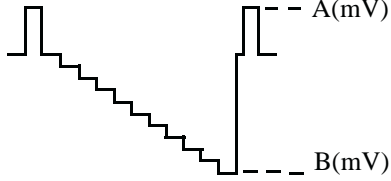
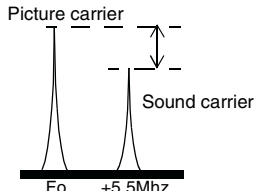
Device and Signals Set-up	Measurement Set-up
Video Differential Gain	
<p>Video: 5 step Grey Scale- 1Vpk-pk. No Audio signal This is measured using a Rohde & Schwarz AMFS UHF Demodulator in B/G (using a CCIR Rec. 567 weighting network, 100kHz to 5MHz band with sound trap and envelope detection, and a Rohde & Schwarz UAF Video Analyzer.</p>	<p>On line CCIR 330 shown below, the video analyzer DG measure consists of calculating the difference of the Chroma amplitude at the black level and the different amplitudes at each step of the greyscale. The largest positive or negative difference indicates the distortion.</p>  <p align="center">5-step Greyscale with Chroma subcarrier superimposed (not to scale), line CCIR 330.</p> $\text{DIFF GAIN} = \frac{\text{the largest positive or negative difference}}{\text{the amplitude at position 0}} * 100\%$ <p>The video analyzer method takes the worst step from the first 4 steps.</p>
Video Modulation Depth	
<p>No Audio signal Video: 10 step grey scale</p>	<p>This is measured using a HP8596E Spectrum Analyzer with a TV Trigger option, allowing demodulation and triggering on any specified TV Line. The analyzer is centred on the maximum peak of the Video signal and reduced to zero Hertz span in Linear mode to demodulate the Video carrier.</p>  <p align="center">TV Line Demodulated by Spectrum Analyzer-BG standard</p> <p>The Modulation Depth is calculated as $(A-B)/A \times 100$ in% Same measurement method for L standard, with inverted video.</p>
Picture to Sound ratio	
<p>No Video signal No Audio Signal "PS" bit set to 0 and 1</p>	<p>Measure in dBc sound carrier in reference to picture carrier (TVout_Ref) for "PS" bit=0 (PS=12dB typical) and for "PS" bit=1 (PS=16dB),</p>  <p align="center">Picture carrier Sound carrier Fo +5.5MHz</p>
Audio Modulation Depth - FM Modulation	
<p>Video Black Level Audio signal: 1Khz, 205mVrms. This is measured using a Rohde & Schwarz AMFS Demodulator in B/G and a HP8903A Audio Analyzer at 1kHz</p>	<p>The audio signal 205mV at 1kHz is supplied by the Audio Analyzer, and the FM demodulated signal deviation is indicated on the Demodulator in KHz peak. This value is then converted in% of FM deviation, based on specified standards.</p>

Device and Signals Set-up	Measurement Set-up
Audio Frequency response	
Video Black Level Audio signal: 50Hz to 15KHz, 100mV _{rms} This is measured using a Rohde & Schwarz AMFS Demodulator in B/G and a HP8903A.	The audio signal 1KHz 100mV _{rms} is supplied by the Audio Analyzer, demodulated by the Demodulator and the audio analyzer measures the AC amplitude of this demodulated audio signal: this value is taken as a reference (0dB). The audio signal is then swept from 50Hz to 15KHz, and demodulated AC amplitude is measured in dB relative to the 1KHz reference. Audio pre-emphasis and de-emphasis circuits are engaged, all audio analyzer filters are switched OFF.
Audio Distortion FM	
Audio: 1KHz, adjustable level Video Black Level This is measured using a Rohde & Schwarz AMFS UHF Demodulator in B/G and a HP8903A Audio Analyzer at 1kHz. The output level of the Audio analyzer is varied to obtain a deviation of 50kHz indicated on the Demodulator.	The input arms detector of the Audio Analyzer converts the ac level of the combined signal + noise + distortion to dc. It then removes the fundamental signal (1kHz) after having measured the frequency. The output rms detector converts the residual noise + distortion to dc. The dc voltmeter measures both dc signals and calculates the ratio in% of the two signals. $ADist = (Distorsion + Noise)/(Distorsion + Noise + Signal)$
Audio Signal to Noise	
Audio: 1KHz, adjustable level Video: EBU Color Bars This is measured using a Rohde & Schwarz AMFS Demodulator in B/G and a HP8903A Audio Analyzer at 1kHz. The output level of the Audio analyzer is varied to obtain a Modulation Deviation of 25kHz indicated on the AMFS Demodulator.	The Audio Analyzer alternately turns ON and OFF it's internal audio source to make a measure of the Audio signal plus noise and then another measure of only the noise. The measurement is made using the internal CCIR468-2 Filter of the Audio Analyzer together with the internal 30+/-2kHz (60dB/decade) Lowpass filters. The AMFS demodulator uses a quasi-parallel demodulation as is the case in a normal TV set. In this mode the Nyquist filter is bypassed and the video carrier is used without added delay to effectuate intercarrier conversion. In this mode the phase noise information fully cancels out and the true S/N can be measured $ASN(dB) = 20 \times \log(Signal + Noise)/(Noise)$

13 Modulator Description

13.1 Power ON Settings

At power-ON, the MC44BC373C/4C configuration is as follows:

WRITE MODE	Bit 7	Bit 6	Bit 5	Bit 4	Bit 3	Bit 2	Bit 1	Bit 0	ACK
C1—High Order Bits	1	0	0	0	0	0	0	0	ACK
C0—Low Order Bits	0	0	0	0	1	0	0	0	ACK
FM—High Order Bits	0	0	N11	N10	N9	N8	N7	N6	ACK
FL—Low Order Bits	N5	N4	N3	N2	N1	N0	0	0	ACK
Note: N0 to N11 are set to have UHF oscillator on channel 36 (591.25MHz). Note: Peak White Clip is ON. Note: Sound frequency is 5.5MHz. Note: Logic Output Port is low voltage. Note: Picture to sound ratio is 12dB.									

These settings can be customized in special masked version.

13.2 Power Supply

The three device Vccs (pins 10, 13, 15) must be applied at the same time to ensure all internal blocks are correctly biased. All other pins must not be biased before Vcc is applied to device.

13.3 Standby modes

During standby mode, the modulator is switched to low power consumption: the sound oscillator, UHF oscillator, video and sound modulator sections bias are internally turned OFF. The IIC bus section remains active.

Modulator can be programmed in standby mode with combination of 3 bits: OSC=1, SO=1 and ATT=1

13.4 System L or B/G Selection

SYSL bit internally switches the following functions:

- SYSL = 0 enables B/G system
 - Video modulation polarity Negative
 - Video modulation depth 80% Typical (See “Video Characteristics” on page 10.)
 - Sound modulation type FM
- SYSL = 1 enables L system
 - Video modulation polarity Positive
 - Video modulation depth 90% Typical (See “Video Characteristics” on page 10.)
 - Sound modulation type AM

13.5 Test Bit TB1

This test bit allows a different bus format.

- TB1=0 — All MC44BC373C/4C Functions Available—Normal Mode.
- TB1=1 — Limited Software Compatibility with MC443533. MC44BC373C/4C Functions Not Available. TB1=1, allows a first evaluation of MC44BC373C/4C using software developed for MC44353 devices.

WRITE MODE [†]	Bit 7	Bit 6	Bit 5	Bit 4	Bit 3	Bit 2	Bit 1	Bit 0	ACK
CA—CHIP ADDRESS	1	1	0	0	1	0	1	0	ACK
C1—High Order Bits	1	*	*	*	PS	*	*	SYSL	ACK
C0—Low Order Bits	*	*	*	SFD1	SFD0	1	0	0	ACK
FM—High Order Bits	0	TPEN	N11	N10	N9	N8	N7	N6	ACK
FL—Low Order Bits	N5	N4	N3	N2	N1	N0	*	*	ACK

[†] Case TB1=1 compatible with MC44353

- All "*" are don't care bits.
- PS bit replaces PSD2 bit in MC44353 bus format:
- PS = 0 is for Picture-to-Sound ratio = 12dB
- PS = 1 is for Picture-to-Sound ratio = 16dB
- SFD1 and SFD0 bits have the same definition for both bus formats (MC44353 and MC44BC373C/4C) and allows a select sound frequency between 4.5MHz, 5MHz, 5.5MHz, and 6.5MHz.
- SYSL bit is the same definition for both bus formats (MC44353 and MC44BC373C/4C) and allows a select system L or BG.
- All MC44BC373C/4C functions are set to their default values.

13.6 Transient Output Inhibit

To minimize the risk of interference to other channels while the UHF PLL is acquiring a lock on the desired frequency, the Sound and Video modulators are turned OFF during a time out period for each of the following two cases:

- Power-ON from zero (i.e., all Vcc is switched from 0V to 5V).
- UHF oscillator power-ON from OFF state (i.e., OSC bit is switched from 1 to 0)

There is a time-out of 263ms until the output is enabled. This lets the UHF PLL settle to its programmed frequency. During the 263ms time-out, the sound PLL current source is set to 10 μ A typical to speed up the locking time. After the 263ms time-out, the current source is switched to 1 μ A. Use care when selecting loop filter components, to ensure the loop transient does not exceed this delay.

For test purposes, it is possible to disable the 263ms delay using Test Mode 1–State 1.h (this is called speed up mode).

13.7 UHF Oscillator—VHF range

The UHF oscillator is fully integrated and does not require any external components.

For low frequency testing or VHF range operation (test mode 1, states 1.b to 1.c), the UHF oscillator can be internally divided by: 2, 4, 8, or 16.

13.8 PLL Section

The reference divider is a fixed divide-by-128, resulting in a reference frequency of 31.25 KHz with a 4.0MHz crystal. The 31.25 KHz reference frequency is used for both UHF and Sound PLLs.

The prescaler is a fixed divide-by-8 and is permanently engaged.

The programmable divider division-ratio is controlled by the state of control bits N0 to N11.

The divider-ratio N for a desired frequency F (in MHz) is given by:

$$N = \frac{F}{8} \times \frac{128}{4}$$

with:

$$N = 2048 \times N11 + 1024 \times N10 + \dots + 4 \times N2 + 2 \times N1 + N0$$

Programming a division-ratio N=0 is not allowed.

13.9 Logic Output Port

The LOP pin is used to control any logic function. The primary applications are to control an external attenuator or an external switch, between the antenna input and TV output.

A typical attenuator application with PIN diode is shown. The LOP pin is used to switch the PIN attenuator depending on the signal strength of the Antenna Input, thereby reducing the risks of Intermodulation in certain areas. The LOP may also be used as an OFF position bypass switch or for other logic functions in the application.

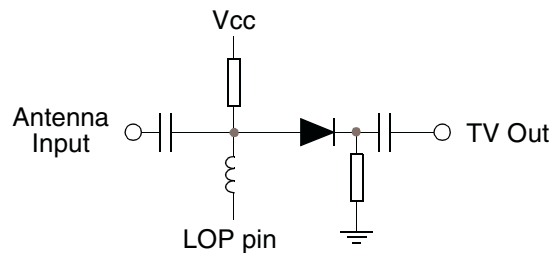

Figure 6. Attenuator Application with PIN Diode

13.10 Video Section - Peak White Clip

The modulator requires the following:

- A composite video input with negative going sync pulses
- A nominal level of 1 Vp-p

This signal is AC-coupled to the video input where the sync tip level is clamped.

The video signal is then passed to a Peak White Clip circuit. The PWC circuit function is to soft-clip the top of the video waveform if the “sync tip amplitude” to “peak white clip” goes too high. This method avoids carrier over-modulation by the video. Clipping can be disabled by software.

13.11 Sound Section

The multivibrator oscillator is fully integrated and does not require any external components. An internal low-pass filter and matched structure give a very low harmonics level.

The sound modulator system consists of the following two types:

- An FM modulator incorporating the sound subcarrier oscillator
- An AM modulator (MC44BC373C only)

The audio input signal is AC-coupled into the amplifier, which then drives both types of modulator.

The audio pre-emphasis circuit is a high-pass filter with an external capacitor and an internal resistor (100kOhms). The recommended capacitor value (470pF) is for BG standard; time constant is 50μS.

13.12 Test Pattern Generator

The IIC generates a simple test pattern, which can be switched under bus control to permit a TV receiver to easily tune to the modulator output. The pattern consists of two white vertical bars on a black background and a 976Hz audio test signal.

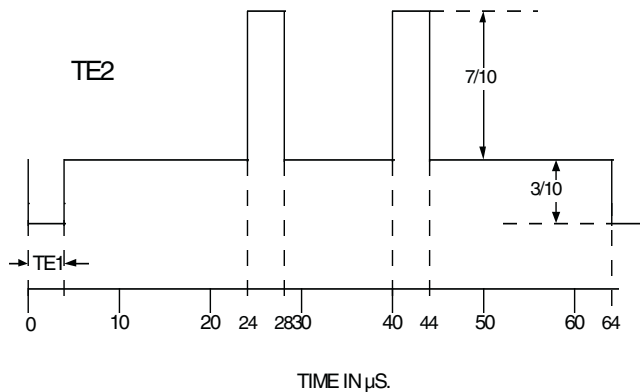
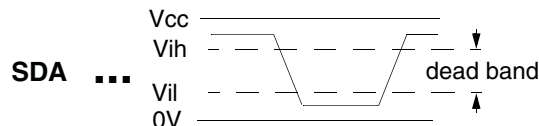
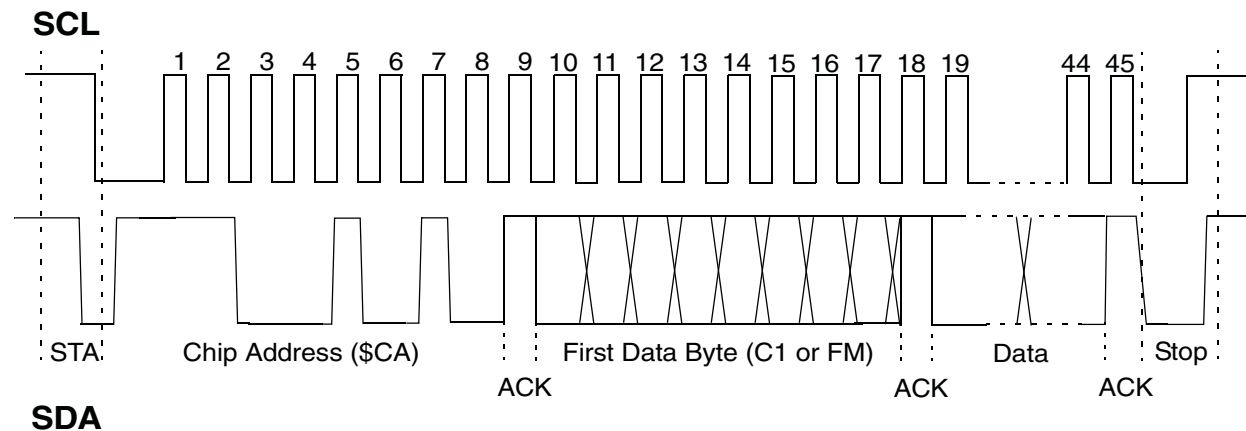

Table 1. Test Pattern Generator

14.3 Levels Definition



14.4 High Speed I²C Compatible Bus Format



14.5 I²C Write Mode Format and Bus Receiver

The bus receiver operates the I²C compatible data format. The chip address (I²C bus) is:

1 1 0 0 1 0 1 0 (ACK) = \$CA (hex) in write mode

In write mode, each ninth data bit (bits 9, 18, 27, 36, and 45) is an acknowledge bit (ACK) during which the MCU sends a logic 1 and the Modulator circuit answers on the data line by pulling it low. Besides the chip address, the circuit needs two or four data bytes for operation. The following sequences of data bytes are the permitted incoming information:

Example 1	STA	CA	C1	C0	STO		
Example 2	STA	CA	FM	FL	STO		
Example 3	STA	CA	C1	C0	FM	FL	STO
Example 4	STA	CA	FM	FL	C1	C0	STO

With:

- STA = Start condition
- FM = Frequency information, high order bits
- C1 = Control information, high order bits
- STO = Stop condition
- CA = Chip Address
- FL = Frequency information, low order bits
- CO = Control information, low order bits

After the chip address, two or four data bytes may be received.

- If three data bytes are received, the third one is ignored.
- If five or more data bytes are received, the fifth and following ones are ignored, and the last ACK pulse is sent at the end of the fourth data byte.

The first and third data bytes contain a function bit, which lets the IC distinguish between frequency information and control information. If the function bit is a logic 1, the two following bytes contain control information. The first data byte after the chip address, may be byte CO or byte FM. The two bytes of frequency information are preceded by a logic 0.

14.6 I²C Read Mode Format

The chip address (I²C) is:

1 1 0 0 1 0 1 1 (ACK) = \$CB (hex) in read mode

The incoming information consists of the read mode chip address byte. The device then answers with an ACK followed by one byte containing three bits of status information. No acknowledge is answered by the modulator after this byte.

15 Pin Circuit Schematics

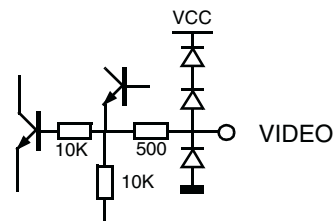
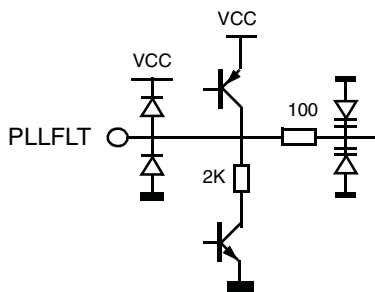
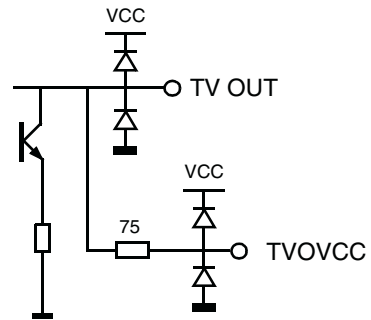
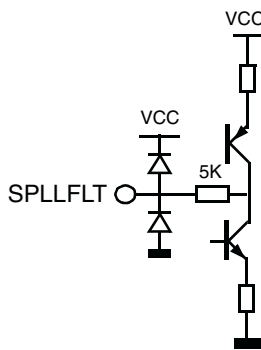
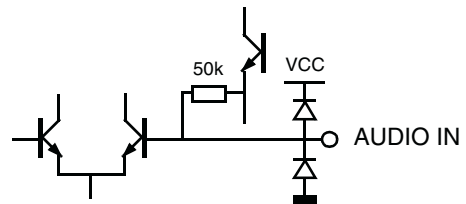
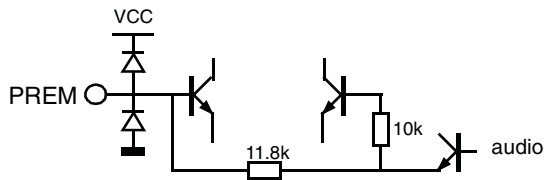
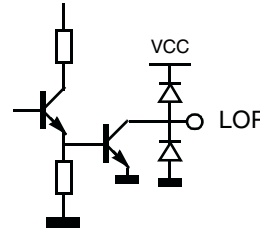
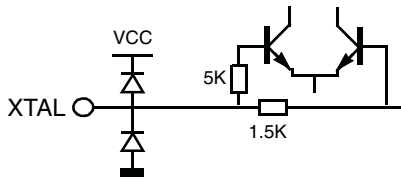
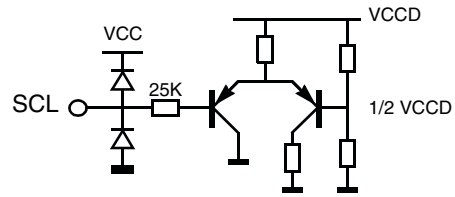
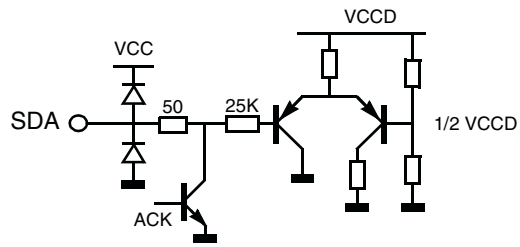

16 Application and Case Diagrams

16.1 Proposed BiCMOS Modulator Application

This document contains information on a new product under development. Motorola reserves the right to change or discontinue this product without notice.

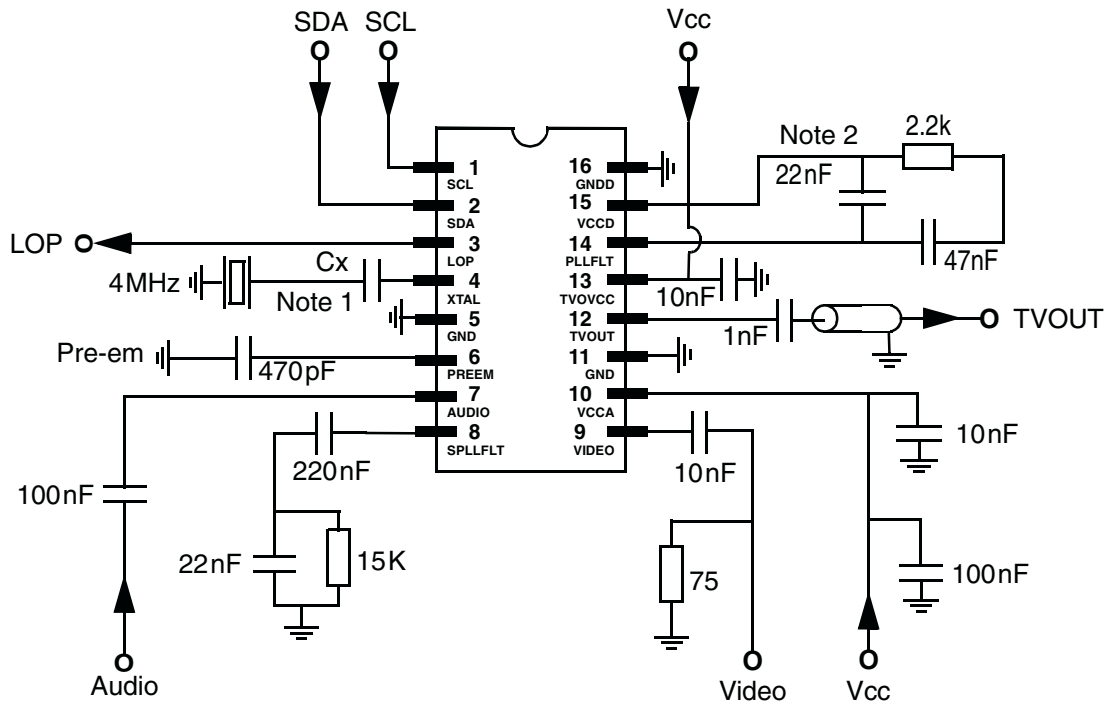

Note 1: Cx value depends on crystal characteristics; Cx = 27 pF on Motorola application board.
 Note 2: Loop Filter components must be as close as possible to pins 14 and 15.

Figure 7. Proposed MC44BC373C/4C Application Schematic

16.2 Packaging Instructions

Tape and reel packaging per 12MRH00360A with the following conditions applicable for Dual In-Line SOP (SOIC) package.

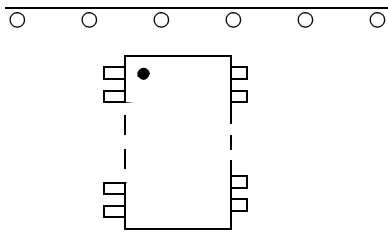

Component Orientation: Arrange parts with the pin 1 side closest to the tape's round sprocket holes on the tape's trailing edge.

16.3 Marking Instructions

SO16NB Package:

Bar marked part way across Pin 1 end of package. Bar width 10 to 20 mils, length to be at least four times Bar width. Bar placement may extend across chamfer and dimple areas.

Pin 1 Dot or Dimple



- 1st line:
44BC373CD for MC44BC373CD device
44BC374CD for MC44BC374CD device
(Part number coded on 10 digits)
- 2nd line:
Assembly site code AW (2 digits) followed by the wafer lot code L (1 digit), year Y (1 digit) and work week WW (2 digits)

TSSOP16 package

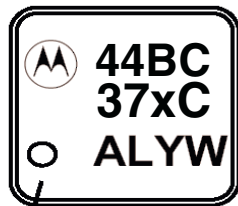

Pin 1 Dot or Dimple

- 1st line: **44BC**
(Part number coded on 4 digits)
- 2nd line: **373C** for MC44BC373CDTB device
374C for MC44BC374CDTB device
(Part number coded on 4 digits)
- 3rd line: Assembly site code A (1 digit) followed by the wafer lot code L (1 digit), year Y (1 digit) and work week W (1 digit)

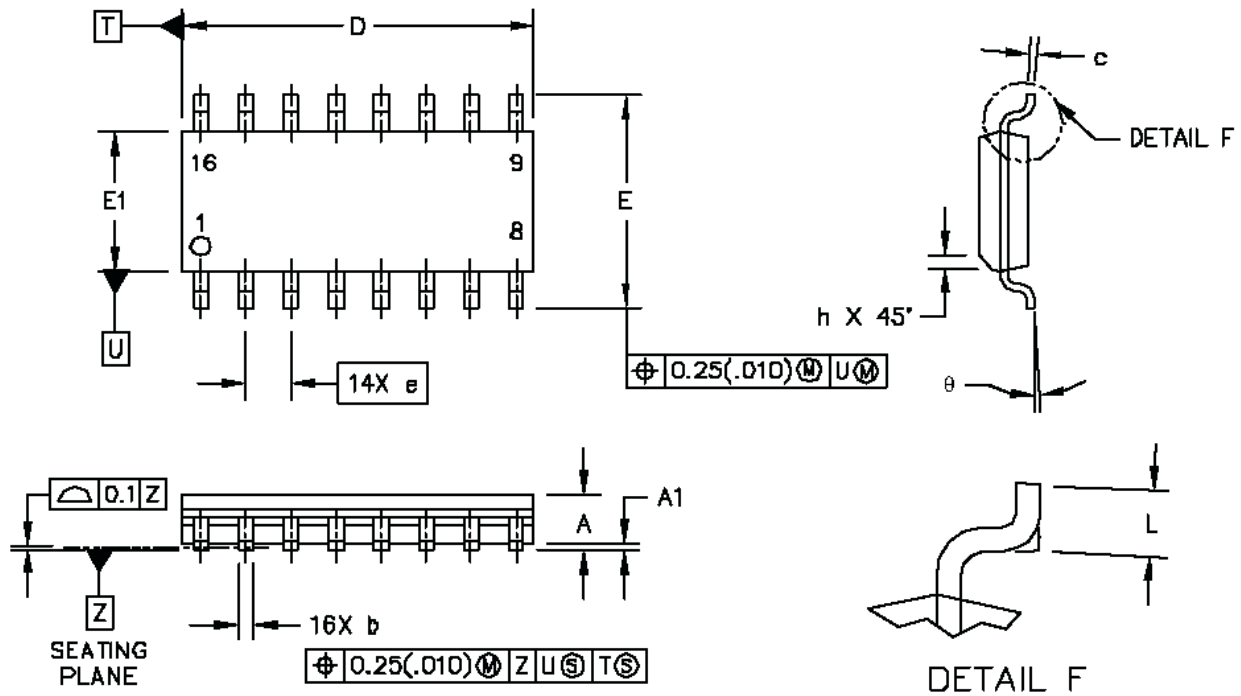

Dim	Millimeters		Inches	
	Min	Max	Min	Max
A	1.35	1.75	0.054	0.068
A1	0.1	0.25	0.004	0.009
D	9.8	10	0.385	0.393
E	5.8	6.2	0.229	0.244
E1	3.8	4	0.150	0.157
b	0.35	0.49	0.014	0.019
c	0.19	0.25	0.008	0.009
e	1.27 BSC		0.050 BSC	
L	0.4	1.25	0.016	0.049
h	0.25	0.5	0.010	0.019
Q	0°	7°	0°	7°

Note: 1. Dimensions and Tolerances per ASME Y14.5M, 1994.
Note: 2. Controlling dimension: Millimeters.
Note: 3. Dimension D and E1 do not include mold protrusion.
Note: 4. Maximum mold protrusion 0.15 (0.006) per side.
Note: 5. Dimension b does not include Dambar protrusion. Allowable Dambar protrusion shall be 0.127 (0.005) total in excess of the b dimension at maximum material condition.

Figure 8. SO16NB Package

- NOTES:
1. DIMENSIONING AND TOLERANCING PER ANSI Y14.5M, 1982.
 2. CONTROLLING DIMENSION: MILLIMETER.
 3. DIMENSION A DOES NOT INCLUDE MOLD FLASH, PROTRUSIONS OR GATE BURRS. MOLD FLASH OR GATE BURRS SHALL NOT EXCEED 0.15 (0.006) PER SIDE.
 4. DIMENSION B DOES NOT INCLUDE INTERLEAD FLASH OR PROTRUSION. INTERLEAD FLASH OR PROTRUSION SHALL NOT EXCEED 0.25 (0.010) PER SIDE.
 5. DIMENSION K DOES NOT INCLUDE DAMBAR PROTRUSION. ALLOWABLE DAMBAR PROTRUSION SHALL BE 0.08 (0.003) TOTAL EXCESS OF THE K DIMENSION AT MAXIMUM MATERIAL CONDITION.
 6. TERMINAL NUMBERS ARE SHOWN FOR REFERENCE ONLY.
 7. DIMENSIONS A AND B ARE TO BE DETERMINED AT DATUM PLANE -U-.

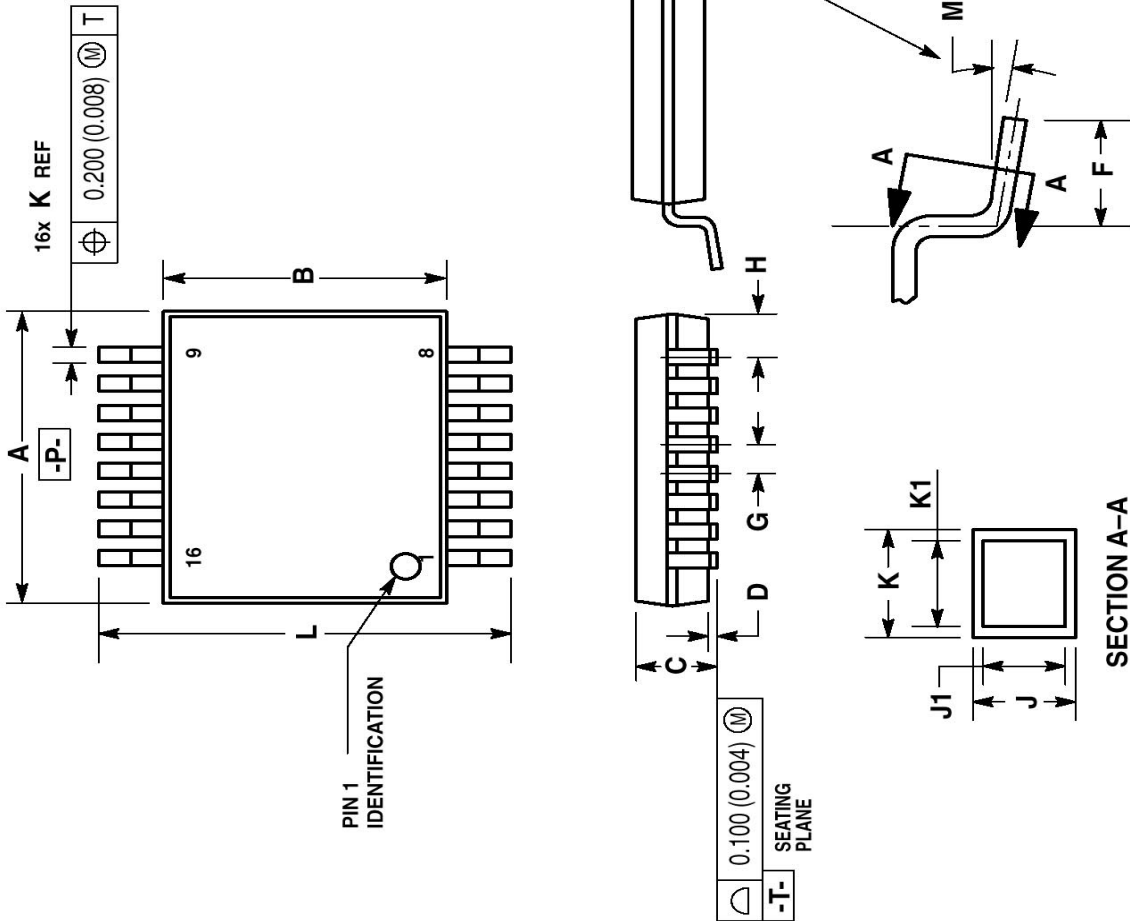

DIM	MILLIMETERS		INCHES	
	MIN	MAX	MIN	MAX
A	5.00 BSC	0.197 BSC	0.197	0.177
B	4.30	4.50	0.169	0.177
C	-	1.10	-	0.043
D	0.05	0.15	0.002	0.006
F	0.40	0.65	0.016	0.026
G	0.65 BSC	0.026 BSC	0.026	0.010
H	0.22	0.23	0.009	0.010
J	0.09	0.20	0.004	0.008
J1	0.09	0.16	0.004	0.006
K	0.19	0.30	0.007	0.012
K1	0.19	0.25	0.007	0.010
L	6.40 BSC	0.252 BSC	0.252	0.010
M	0°	8°	0°	8°

Figure 9. TSSOP16 Package

HOW TO REACH US:

USA/EUROPE/LOCATIONS NOT LISTED:

Motorola Literature Distribution;
P.O. Box 5405, Denver, Colorado 80217
1-303-675-2140 or 1-800-441-2447

JAPAN:

Motorola Japan Ltd.; SPS, Technical Information Center,
3-20-1, Minami-Azabu Minato-ku, Tokyo 106-8573 Japan
81-3-3440-3569

ASIA/PACIFIC:

Motorola Semiconductors H.K. Ltd.; Silicon Harbour
Centre, 2 Dai King Street, Tai Po Industrial Estate,
Tai Po, N.T., Hong Kong
852-26668334

TECHNICAL INFORMATION CENTER:

1-800-521-6274

HOME PAGE:

<http://www.motorola.com/semiconductors>

Information in this document is provided solely to enable system and software implementers to use Motorola products. There are no express or implied copyright licenses granted hereunder to design or fabricate any integrated circuits or integrated circuits based on the information in this document.

Motorola reserves the right to make changes without further notice to any products herein. Motorola makes no warranty, representation or guarantee regarding the suitability of its products for any particular purpose, nor does Motorola assume any liability arising out of the application or use of any product or circuit, and specifically disclaims any and all liability, including without limitation consequential or incidental damages. "Typical" parameters which may be provided in Motorola data sheets and/or specifications can and do vary in different applications and actual performance may vary over time. All operating parameters, including "Typicals" must be validated for each customer application by customer's technical experts. Motorola does not convey any license under its patent rights nor the rights of others. Motorola products are not designed, intended, or authorized for use as components in systems intended for surgical implant into the body, or other applications intended to support or sustain life, or for any other application in which the failure of the Motorola product could create a situation where personal injury or death may occur. Should Buyer purchase or use Motorola products for any such unintended or unauthorized application, Buyer shall indemnify and hold Motorola and its officers, employees, subsidiaries, affiliates, and distributors harmless against all claims, costs, damages, and expenses, and reasonable attorney fees arising out of, directly or indirectly, any claim of personal injury or death associated with such unintended or unauthorized use, even if such claim alleges that Motorola was negligent regarding the design or manufacture of the part.



Motorola and the Stylized M Logo are registered in the U.S. Patent and Trademark Office. All other product or service names are the property of their respective owners. Motorola, Inc. is an Equal Opportunity/Affirmative Action Employer.

© Motorola, Inc. 2002

MC44BC373C/D

**For More Information On This Product,
Go to: www.freescale.com**