

**DUAL LOW-NOISE OPERATIONAL AMPLIFIERS (DUAL POWER SUPPLY TYPE)**

**DESCRIPTION**

The M5218 are semiconductor integrated circuits designed for a low noise preamplifier in audio equipment and a general-purpose operational amplifier in other electronic equipment. Two low noise operational amplifier circuits displaying internal phase-compensated high gain and low distortion are contained in an 8-pin SIP, DIP or FP for application over a wide range as a general-purpose dual amplifier in general electronic equipment.

The devices have virtually the same characteristics as the 4557, 4558, 4559 and 741 operational amplifiers.

The units can also be used as a single power supply type and amplifier in portable equipment. It is also suitable as a headphone amplifier because of its high load current.

**FEATURES**

- High gain, low distortion  
 .....  $G_{VO}=110\text{dB}$ ,  $T_{HE}=0.0015\%$ (typ.)
- High slew rate, high  $f_T$   
 .....  $SR=2.2\text{V}/\mu\text{s}$ ,  $f_T=7\text{MHz}$ (typ.)
- Low noise ( $R_S=1\text{k}\Omega$ ) FLAT .....  $V_{NI}=2\mu\text{Vrms}$ (typ.)  
 RIAA .....  $V_{NI}=1\mu\text{Vrms}$ (typ.)
- Operation with low supply voltage  
 .....  $V_{CC}\geq 4\text{V}(\pm 2\text{V})$
- High load current, high power dissipation  
 .....  $I_{LP}=\pm 50\text{mA}$ ,  $P_d=800\text{mW}$ (SIP)  
 $P_d=625\text{mW}$ (DIP),  $P_d=440\text{mW}$ (FP)

**APPLICATION**

General-purpose amplifier in stereo equipment, tape decks, and radio stereo cassette recorders; active filters, servo amplifiers, operational circuits in other general electronic equipment.

**RECOMMENDED OPERATING CONDITION**

- Supply voltage range .....  $\pm 2\sim\pm 16\text{V}$
- Rated supply voltage .....  $\pm 15\text{V}$

**PIN CONFIGURATION (TOP VIEW)**

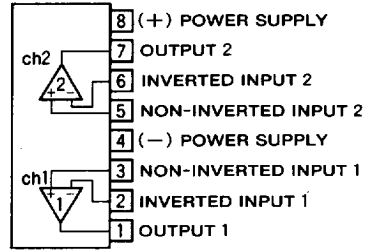

Outline 8P5 (AL)

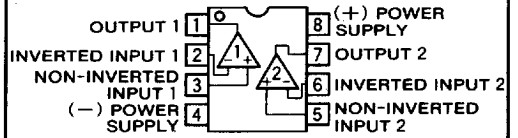

Outline 8P4 (AP)  
 8P2S-A (AFP)

**BLOCK DIAGRAM**

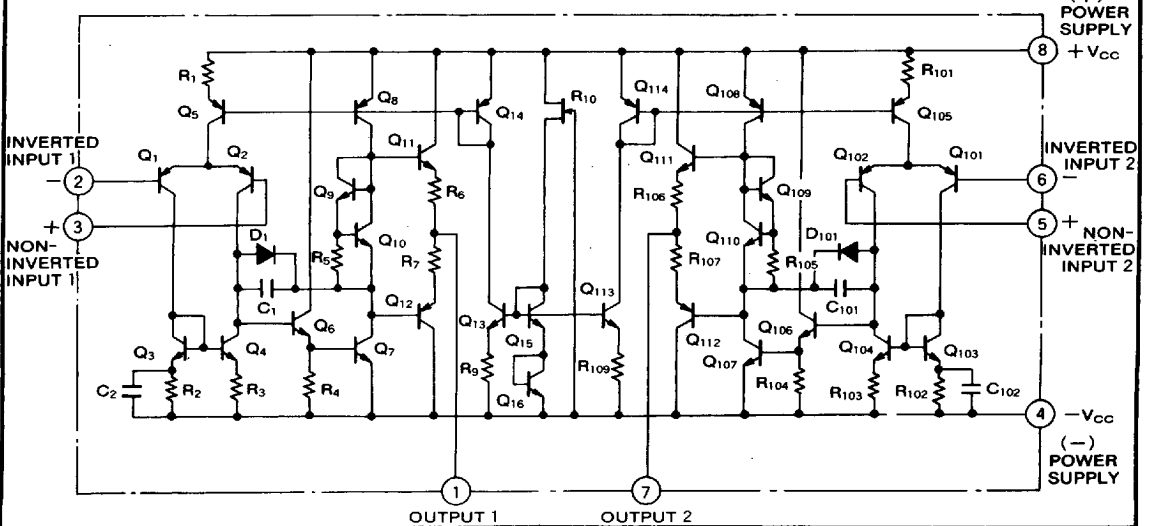

6249826 0021533 477



**DUAL LOW-NOISE OPERATIONAL AMPLIFIERS (DUAL POWER SUPPLY TYPE)**

**ABSOLUTE MAXIMUM RATINGS** ( $T_a=25^{\circ}\text{C}$ , unless otherwise noted)

Symbol	Parameter	Conditions	Ratings	Unit
$V_{CC}$	Supply voltage		$\pm 18$	V
$I_{LP}$	Load current		$\pm 50$	mA
$V_{id}$	Differential input voltage		$\pm 30$	V
$V_{ic}$	Common input voltage		$\pm 15$	V
$P_d$	Power dissipation		800(SIP)/625(DIP)/440(FP)	mW
$K_{\theta}$	Thermal derating	$T_a \geq 25^{\circ}\text{C}$	8(SIP)/6.25(DIP)/4.4(FP)	mW/ $^{\circ}\text{C}$
$T_{opr}$	Ambient temperature		$-20 \sim +75$	$^{\circ}\text{C}$
$T_{stg}$	Storage temperature		$-55 \sim +125$	$^{\circ}\text{C}$

**ELECTRICAL CHARACTERISTICS** ( $T_a=25^{\circ}\text{C}$ ,  $V_{CC}=\pm 15\text{V}$ )

Symbol	Parameter	Test conditions	Limits			Unit
			Min.	Typ.	Max.	
$I_{CC}$	Circuit current	$V_{in}=0$		3.0	6.0	mA
$V_{IO}$	Input offset voltage	$R_S \leq 10\text{k}\Omega$		0.5	6.0	mV
$I_{IO}$	Input offset current			5	200	nA
$I_{IB}$	Input bias current				500	nA
$R_{in}$	Input resistance		0.3	5		M $\Omega$
$G_{VO}$	Open loop voltage gain	$R_L \geq 2\text{k}\Omega$ , $V_O = \pm 10\text{V}$	86	110		dB
$V_{OM}$	Maximum output voltage	$R_L \geq 10\text{k}\Omega$	$\pm 12$	$\pm 14$		V
		$R_L \geq 2\text{k}\Omega$	$\pm 10$	$\pm 13$		
$V_{CM}$	Common input voltage range		$\pm 12$	$\pm 14$		V
CMRR	Common mode rejection ratio	$R_S \leq 10\text{k}\Omega$	70	90		dB
SVRR	Supply voltage	$R_S \leq 10\text{k}\Omega$		30	150	$\mu\text{V}/\text{V}$
$P_d$	Power dissipation			90	180	mW
SR	Slew rate	$G_v=0\text{dB}$ , $R_L=2\text{k}\Omega$		2.2		V/ $\mu\text{s}$
$f_T$	Gain bandwidth product			7		MHz
$V_{NI}$	Input referred noise voltage	$R_S=1\text{k}\Omega$ , BW:10Hz $\sim$ 30kHz		2.0		$\mu\text{Vrms}$

**TYPICAL CHARACTERISTICS**

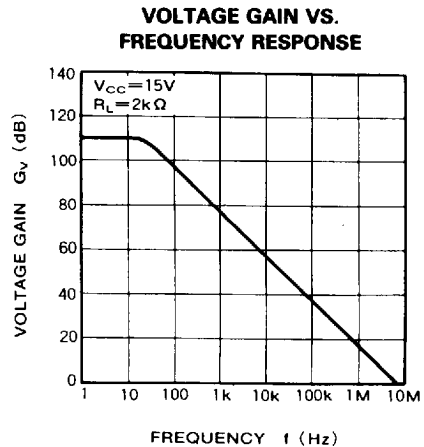
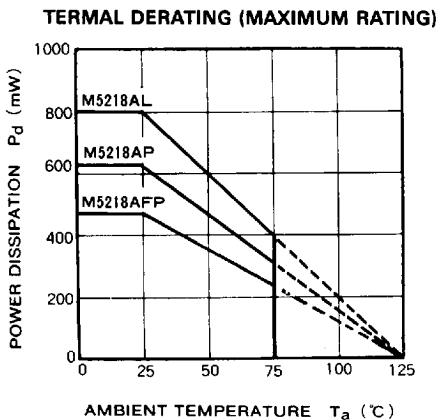

6249826 0021534 303



DUAL LOW-NOISE OPERATIONAL AMPLIFIERS (DUAL POWER SUPPLY TYPE)

CIRCUIT CURRENT VS. SUPPLY VOLTAGE

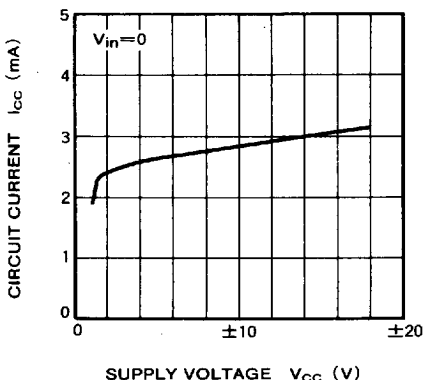

CIRCUIT CURRENT VS. AMBIENT TEMPERATURE

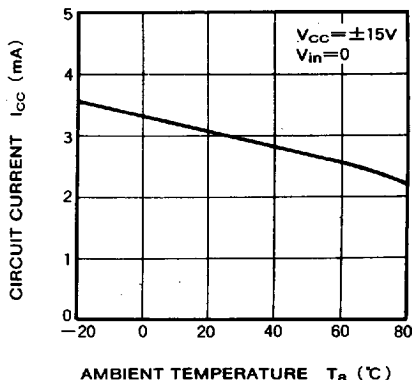

INPUT OFFSET VOLTAGE VS. AMBIENT TEMPERATURE

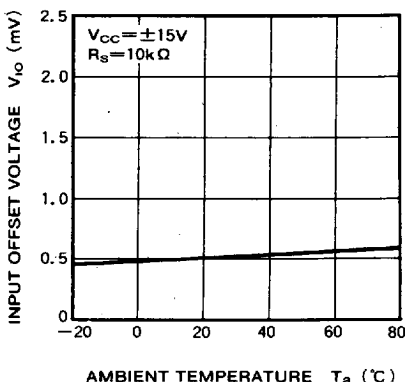

OUTPUT VOLTAGE / LOAD CURRENT PEAK VS. LOAD RESISTANCE

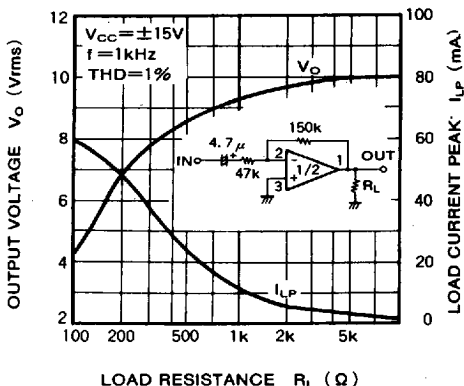

MAXIMUM OUTPUT VOLTAGE VS. SUPPLY VOLTAGE

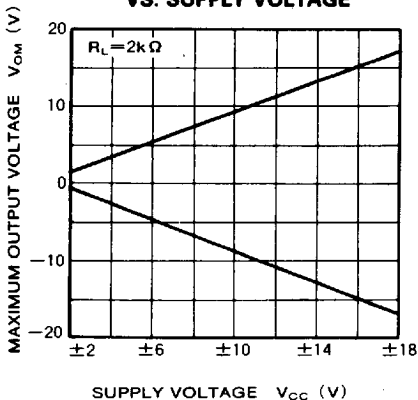

MAXIMUM OUTPUT VOLTAGE VS. FREQUENCY RESPONSE

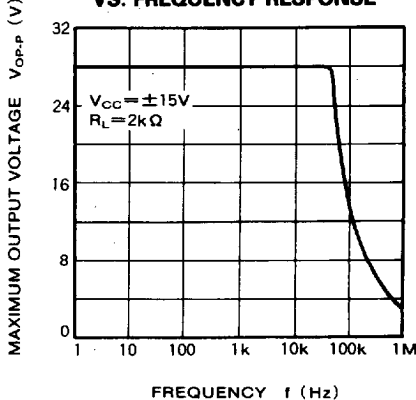

6249826 0021535 24T



**DUAL LOW-NOISE OPERATIONAL AMPLIFIERS (DUAL POWER SUPPLY TYPE)**

**APPLICATION EXAMPLES**

**(1) Stereo Equalizer amplifier circuit**

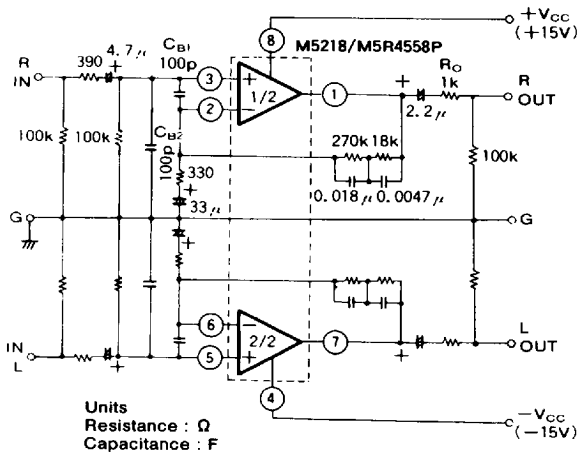

Left channel circuit constants are identical to those of right channel.  
 $C_{B1}$ ,  $C_{B2}$  : Capacitors for buzz prevention, use if required.  
 $R_O$  : Resistor used to prevent parasitic oscillation for capacitive loads and current limiting with shorted and other abnormal load conditions.

**TYPICAL CHARACTERISTICS ( $V_{CC} = \pm 15V$ , RIAA)**

- $G_v = 35.6 \text{ dB}$  ( $f = 1 \text{ kHz}$ )
- $V_{NI} = 1 \mu\text{Vrms}$  ( $R_s = 1 \text{ k}\Omega$ ,  $\text{BW} = 20 \text{ Hz} \sim 30 \text{ kHz}$ )
- Signal-to-noise = 72.5 dB (IHF-A network, shorted input, 2.5 mVrms input sensitivity)
- THD = 0.0015% ( $f = 1 \text{ kHz}$ ,  $V_O = 3 \text{ Vrms}$ )

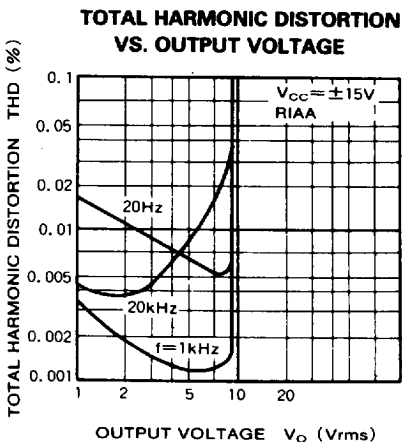

**OUTPUT NOISE VOLTAGE VS. SIGNAL SOURCE RESISTANCE**

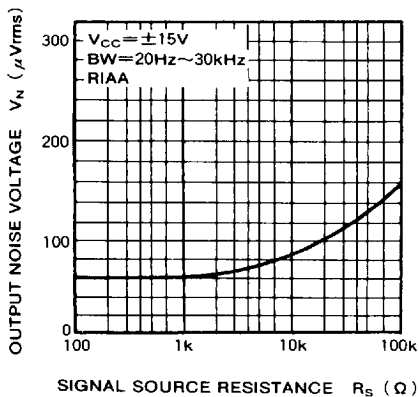

**SIGNAL-TO-NOISE RATIO VS. SIGNAL SOURCE RESISTANCE**

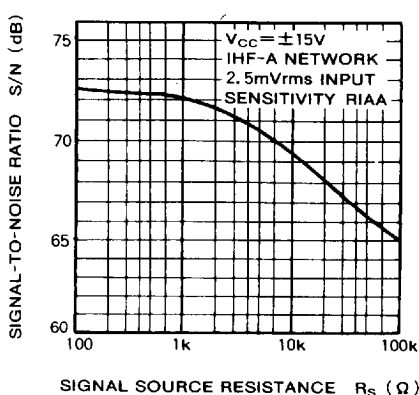

6249826 0021536 186



**DUAL LOW-NOISE OPERATIONAL AMPLIFIERS (DUAL POWER SUPPLY TYPE)**

**(2) High S / N stereo DC ICL equalizer**

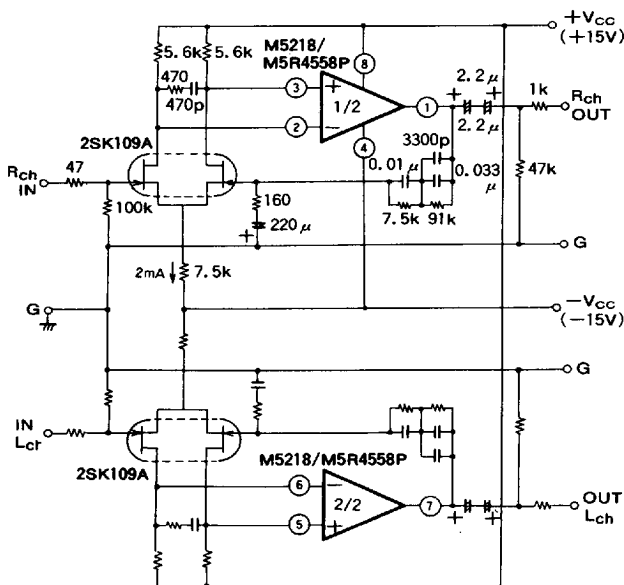

**TYPICAL CHARACTERISTICS** ( $V_{CC} = \pm 15V$ , RIAA)

- Signal-to-noise = 72.5dB (IHF-A network, shorted input, 2.5mVrms input sensitivity)
- $V_{NI} = 0.77 \mu V_{rms}$  ( $R_S = 5.1k\Omega$ , BW = 5Hz ~ 100kHz)
- $G_V = 35.6dB$  ( $f = 1kHz$ )

**TOTAL HARMONIC DISTORTION VS. OUTPUT VOLTAGE**

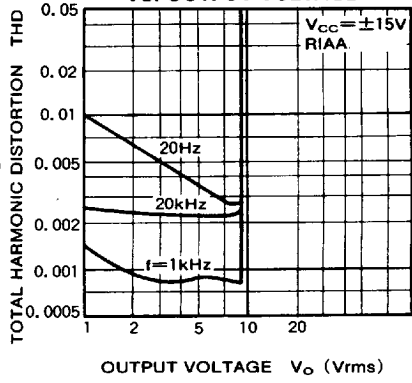

Left channel circuit constants are identical to those of right channel.

Units Resistance :  $\Omega$   
Capacitance : F

**(3) Headphone amplifier**

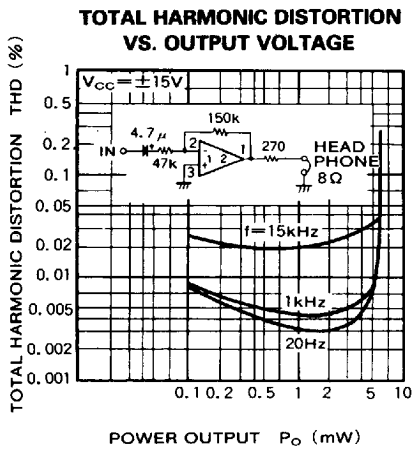

(Output resistance  $R_O$  is made the parameter)

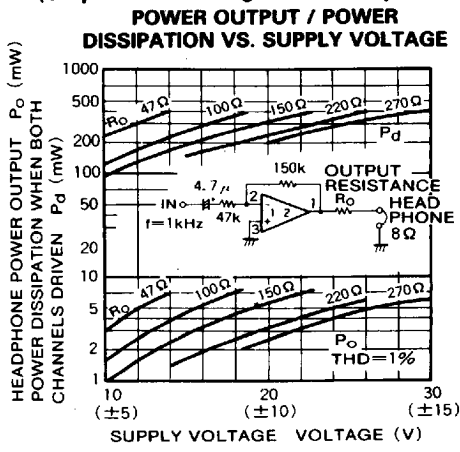

6249826 0021537 012

