

# 2SC4960, 2SC4960A

Silicon NPN triple diffusion planar type

For power switching

## Features

- High-speed switching
- High collector to base voltage  $V_{CBO}$
- Satisfactory linearity of forward current transfer ratio  $h_{FE}$
- Full-pack package with outstanding insulation, which can be installed to the heat sink with one screw

## Absolute Maximum Ratings ( $T_C=25^\circ\text{C}$ )

Parameter	Symbol	Rated	Unit	
Collector to base voltage	$V_{CBO}$	2SC4960	900	V
		2SC4960A	900	
Collector to emitter voltage	$V_{CES}$	900	V	
Collector to emitter voltage	$V_{CEO}$	2SC4960	800	V
		2SC4960A	900	
Emitter to base voltage	$V_{EBO}$	7	V	
Peak collector current	$I_{CP}$	2	A	
Collector current	$I_C$	1	A	
Base current	$I_B$	0.3	A	
Collector power dissipation	$P_C$	$T_C=25^\circ\text{C}$	40	W
		$T_a=25^\circ\text{C}$	3	
Junction temperature	$T_j$	150	$^\circ\text{C}$	
Storage temperature	$T_{stg}$	-55 to +150	$^\circ\text{C}$	

## Electrical Characteristics ( $T_C=25^\circ\text{C}$ )

Parameter	Symbol	Conditions	min	typ	max	Unit
Collector cutoff current	$I_{CBO}$	$V_{CB} = 900\text{V}, I_E = 0$			50	$\mu\text{A}$
Emitter cutoff current	$I_{EBO}$	$V_{EB} = 7\text{V}, I_C = 0$			50	$\mu\text{A}$
Collector to emitter voltage	$V_{CEO}$	$I_C = 1\text{mA}, I_B = 0$	800			V
		$I_C = 1\text{mA}, I_B = 0$	900			
Forward current transfer ratio	$h_{FE1}$	$V_{CE} = 5\text{V}, I_C = 0.05\text{A}$	6			
	$h_{FE2}$	$V_{CE} = 5\text{V}, I_C = 0.5\text{A}$	3			
Collector to emitter saturation voltage	$V_{CE(sat)}$	$I_C = 0.2\text{A}, I_B = 0.04\text{A}$			1.5	V
Base to emitter saturation voltage	$V_{BE(sat)}$	$I_C = 0.2\text{A}, I_B = 0.04\text{A}$			1	V
Transition frequency	$f_T$	$V_{CE} = 10\text{V}, I_C = 0.05\text{A}, f = 1\text{MHz}$		4		MHz
Turn-on time	$t_{on}$	$I_C = 0.2\text{A}, I_{B1} = 0.04\text{A}, I_{B2} = -0.08\text{A}, V_{CC} = 250\text{V}$			1	$\mu\text{s}$
Storage time	$t_{stg}$				3	$\mu\text{s}$
Fall time	$t_f$				1	$\mu\text{s}$

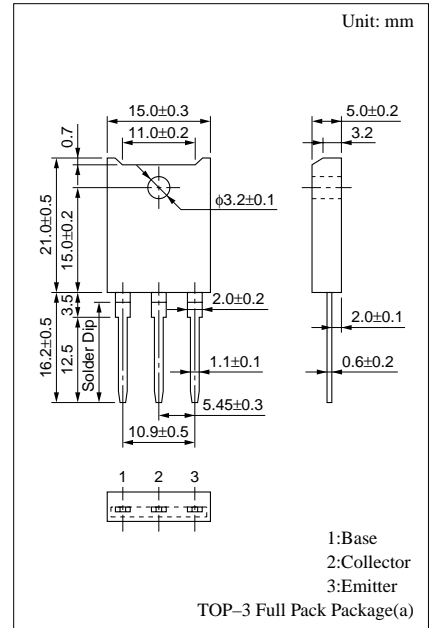

$P_C - T_a$

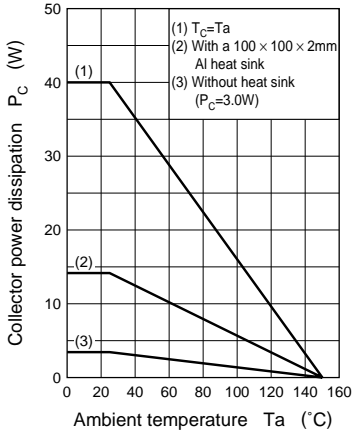

$I_C - V_{CE}$

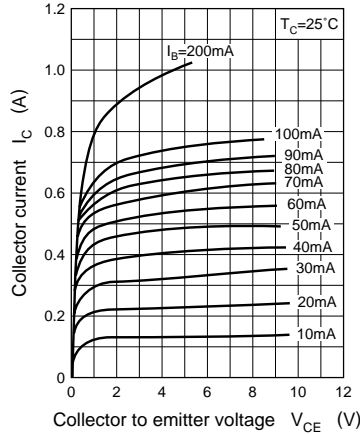

$V_{CE(sat)} - I_C$

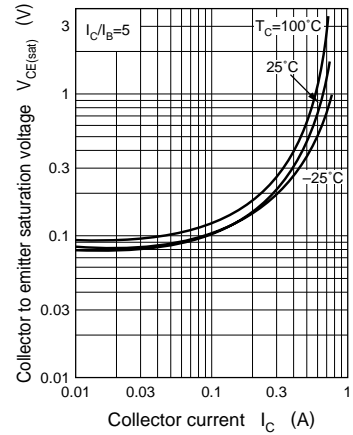

$V_{BE(sat)} - I_C$

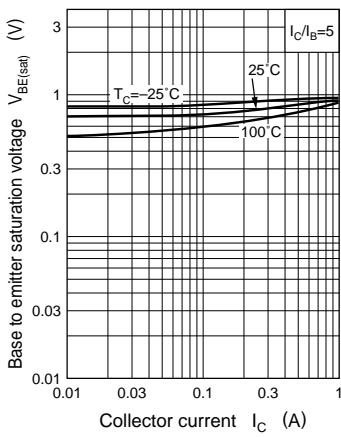

$h_{FE} - I_C$

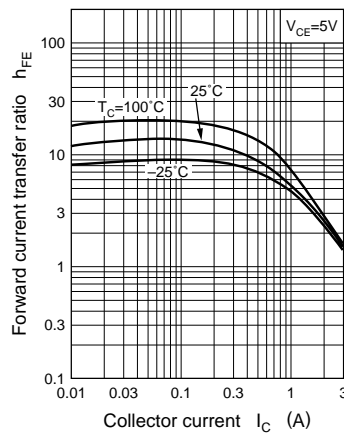

$f_T - I_C$

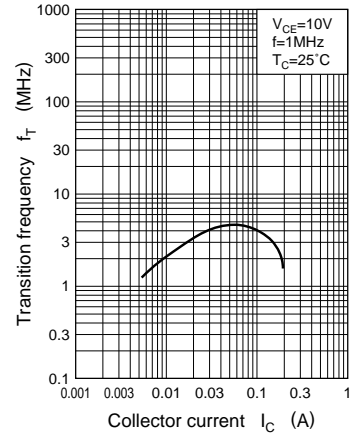

$t_{on}, t_{stg}, t_f - I_C$

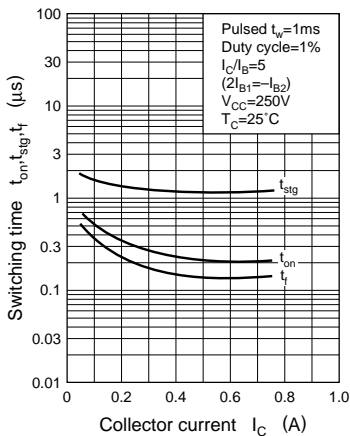

Area of safe operation (ASO)

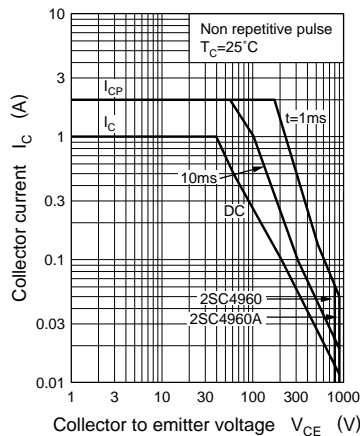

Area of safe operation, reverse bias ASO

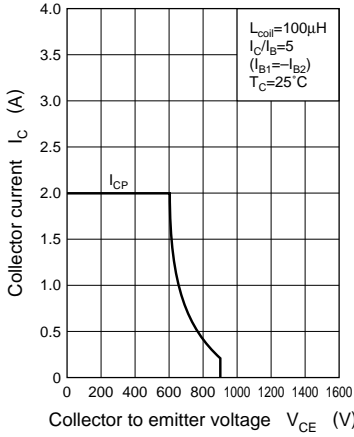

Reverse bias ASO measuring circuit



$R_{th(t)} - t$

