

**8-PIN SOP, 260 V BREAK DOWN VOLTAGE  
2-ch Optical Coupled MOS FET****DESCRIPTION**

The PS7221A-2A is a solid state relay containing GaAs LEDs on the light emitting side (input side) and MOS FETs on the output side.

It is suitable for analog signal control because of its low offset and high linearity.

**FEATURES**

- 2 channel type (1 a + 1 a output)
- Low LED operating current ( $I_f = 1 \text{ mA}$ )
- Designed for AC/DC switching line changer
- Small and thin package (8-pin SOP, Height = 2.1 mm)
- Low offset voltage
- Ordering number of taping product: PS7221A-2A-F3, F4

**APPLICATIONS**

- Exchange equipment (FAX, MODEM, OCU + SLIC, etc.)
- Measurement equipment
- FA/OA equipment

The information in this document is subject to change without notice. Before using this document, please confirm that this is the latest version.  
Not all devices/types available in every country. Please check with local NEC representative for availability and additional information.

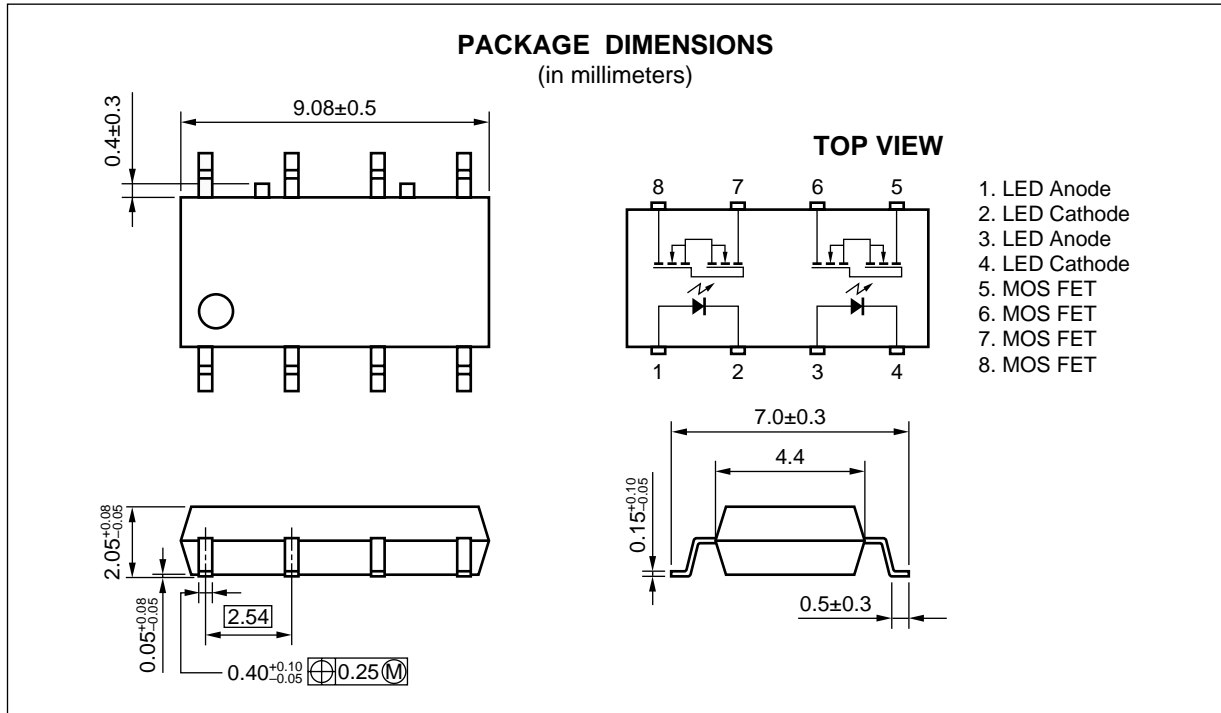

★ ORDERING INFORMATION

Part Number	Package	Packing Style	Application Part Number <sup>*1</sup>
PS7221A-2A	8-pin SOP	Magazine case 45 pcs	PS7221A-2A
PS7221A-2A -F3		Embossed Tape 1 500 pcs/reel	
PS7221A-2A -F4			

\*1 For the application of the Safety Standard, following part number should be used.

**ABSOLUTE MAXIMUM RATINGS (T<sub>A</sub> = 25 °C, unless otherwise specified)**

Parameter		Symbol	Ratings	Unit
Diode	Forward Current (DC)	I <sub>F</sub>	50	mA
	Reverse Voltage	V <sub>R</sub>	5.0	V
	Power Dissipation	P <sub>D</sub>	50	mW/ch
	Peak Forward Current <sup>*1</sup>	I <sub>FP</sub>	1	A
MOS FET	Break Down Voltage	V <sub>L</sub>	260	V
	Continuous Load Current	I <sub>L</sub>	170	mA
	Pulse Load Current <sup>*2</sup> (AC/DC Connection)	I <sub>LP</sub>	300	mA
	Power Dissipation	P <sub>D</sub>	180	mW/ch
Isolation Voltage <sup>*3</sup>		BV	1 500	Vr.m.s.
Total Power Dissipation		P <sub>T</sub>	460	mW
Operating Ambient Temperature		T <sub>A</sub>	-40 to +80	°C
Storage Temperature		T <sub>stg</sub>	-40 to +100	°C

\*1 PW = 100 μs, Duty Cycle = 1 %

\*2 PW = 100 ms, 1 shot

\*3 AC voltage for 1 minute at T<sub>A</sub> = 25 °C, RH = 60 % between input and output

**RECOMMENDED OPERATING CONDITIONS (T<sub>A</sub> = 25 °C)**

Parameter	Symbol	MIN.	TYP.	MAX.	Unit
LED Operating Current	I <sub>F</sub>	1	10	20	mA
LED Off Voltage	V <sub>F</sub>	0		0.5	V

★

**★ ELECTRICAL CHARACTERISTICS (T<sub>A</sub> = 25 °C)**

Parameter		Symbol	Conditions	MIN.	TYP.	MAX.	Unit
Diode	Forward Voltage	V <sub>F</sub>	I <sub>F</sub> = 5 mA		1.1	1.4	V
	Reverse Current	I <sub>R</sub>	V <sub>R</sub> = 5 V			5.0	μA
MOS FET	Off-state Leakage Current	I <sub>Loff</sub>	V <sub>D</sub> = 260 V			1.0	μA
	Output Capacitance	C <sub>out</sub>	V <sub>D</sub> = 0 V, f = 1 MHz		122		pF/ch
Coupled	LED On-state Current	I <sub>Fon</sub>	I <sub>L</sub> = 170 mA			1.0	mA
	On-state Resistance	R <sub>on</sub>	I <sub>F</sub> = 10 mA, I <sub>L</sub> = 10 mA		3.4	10	Ω
	Turn-on Time *1	t <sub>on</sub>	I <sub>F</sub> = 10 mA, V <sub>O</sub> = 5 V, R <sub>L</sub> = 500 Ω,		0.4	1.0	ms
	Turn-off Time *1	t <sub>off</sub>	PW ≥ 10 ms		0.03	0.2	
	Isolation Resistance	R <sub>I-O</sub>	V <sub>I-O</sub> = 1.0 kV <sub>DC</sub>		10 <sup>9</sup>		Ω
	Isolation Capacitance	C <sub>I-O</sub>	V = 0 V, f = 1 MHz			0.4	pF/ch

\*1 Test Circuit for Switching Time

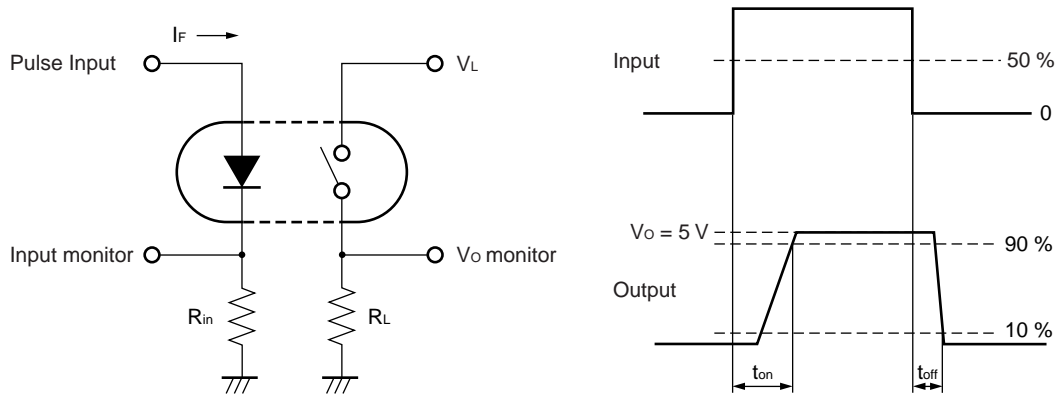

★ TYPICAL CHARACTERISTICS (T<sub>A</sub> = 25 °C, unless otherwise specified)

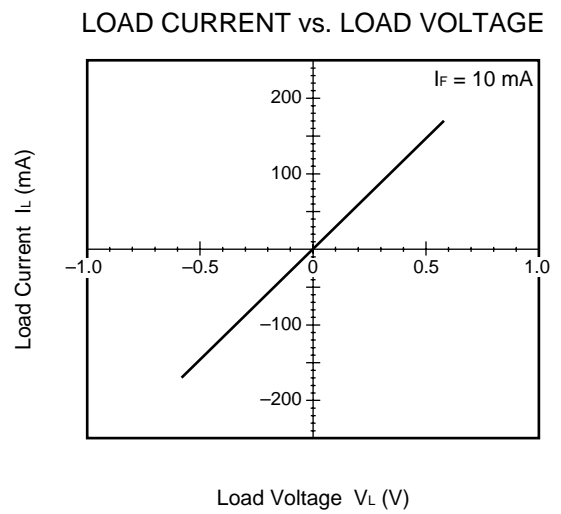
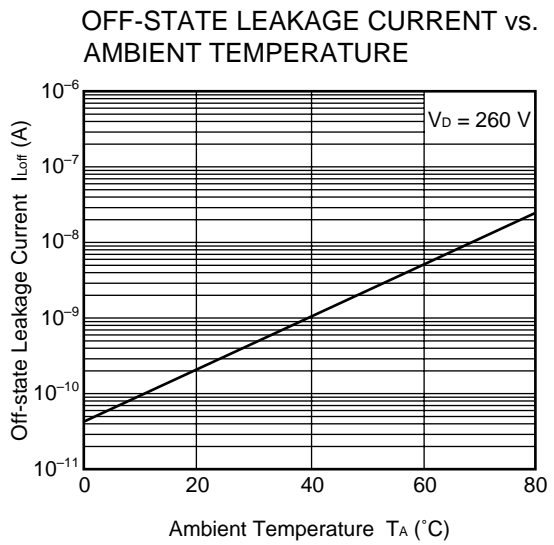
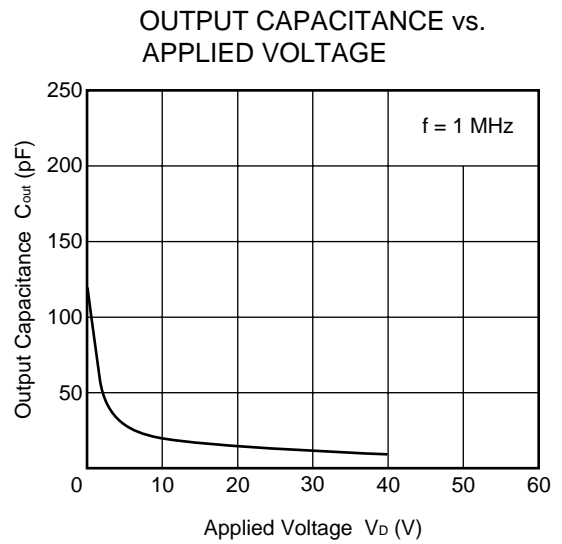
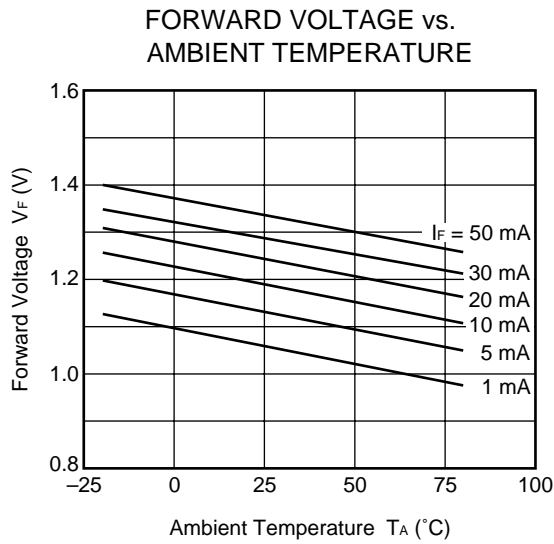
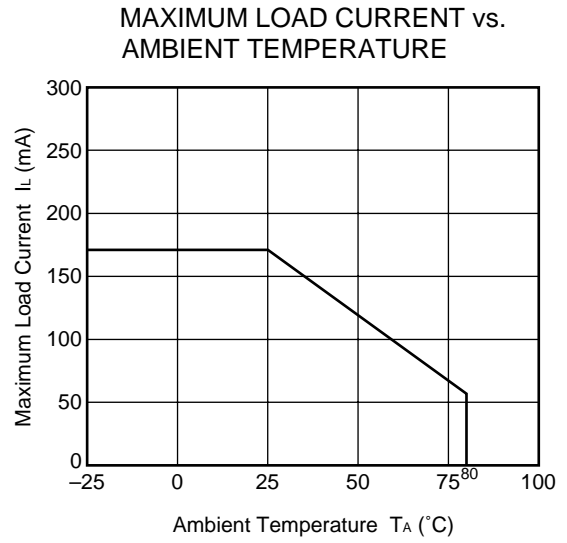
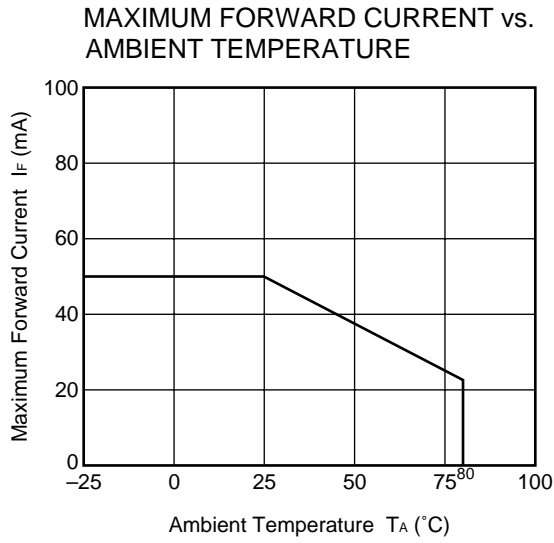

NORMALIZED ON-STATE RESISTANCE vs. AMBIENT TEMPERATURE

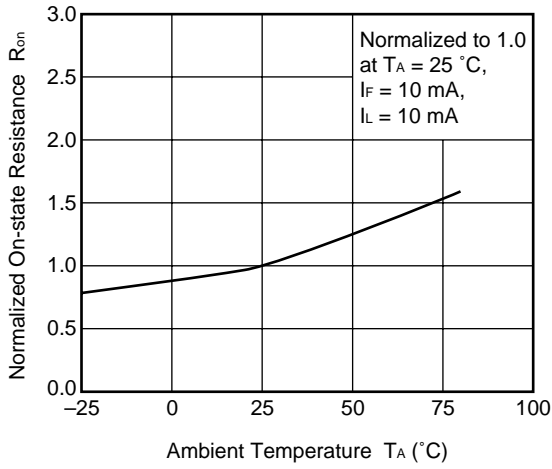

ON-STATE RESISTANCE DISTRIBUTION

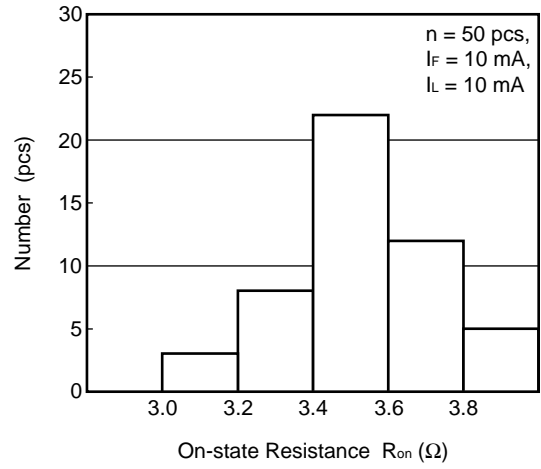

TURN-ON TIME vs. FORWARD CURRENT

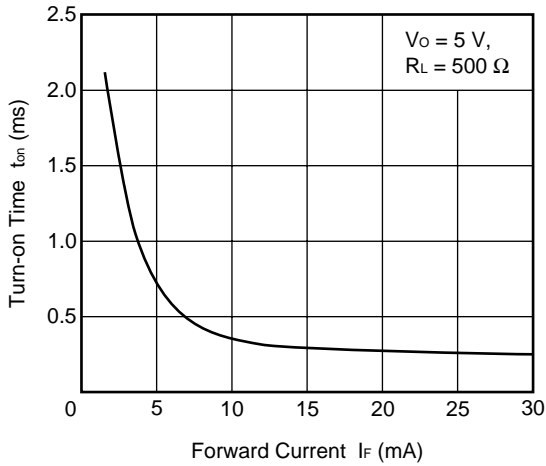

TURN-OFF TIME vs. FORWARD CURRENT

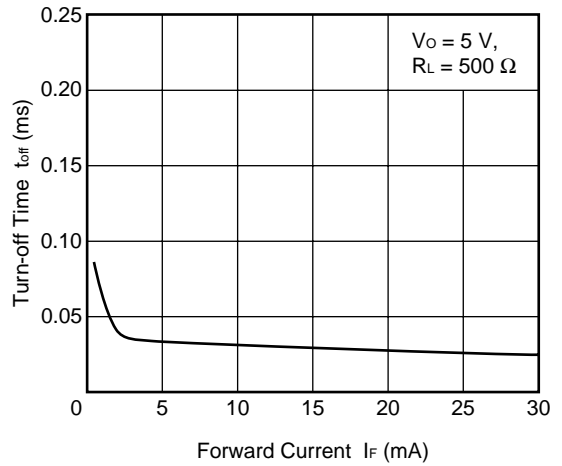

TURN-ON TIME DISTRIBUTION

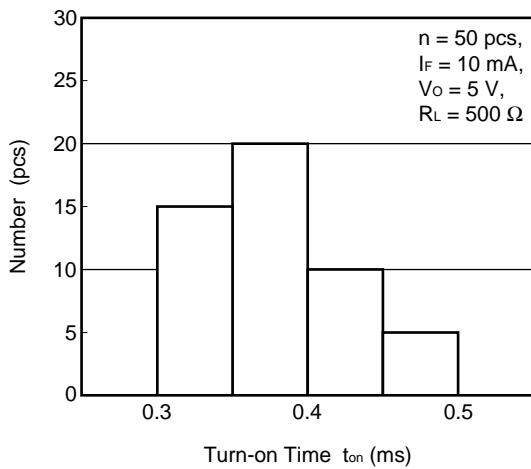

TURN-OFF TIME DISTRIBUTION

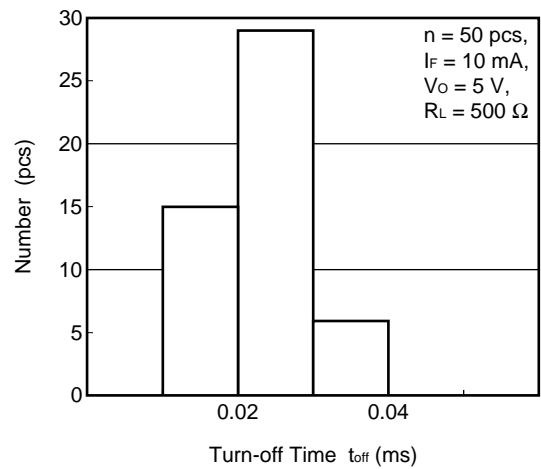

NORMALIZED TURN-ON TIME vs. AMBIENT TEMPERATURE

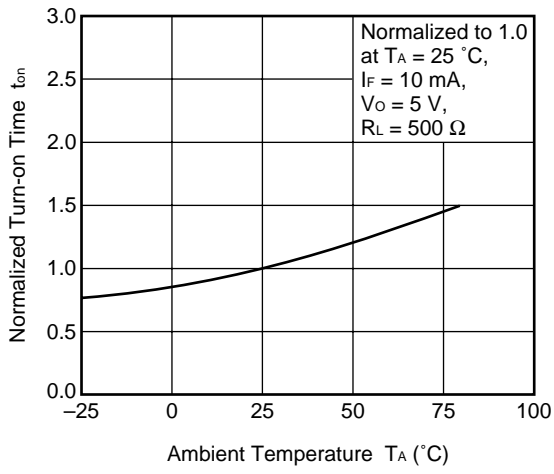

NORMALIZED TURN-OFF TIME vs. AMBIENT TEMPERATURE

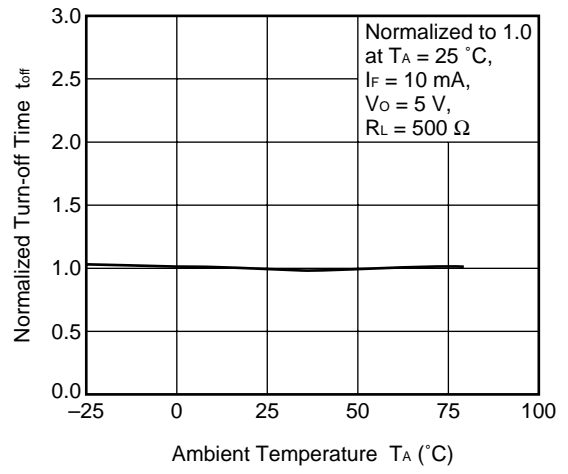

**Remark** The graphs indicate nominal characteristics.

★ TAPING SPECIFICATIONS (in millimeters)

Outline and Dimensions (Tape)

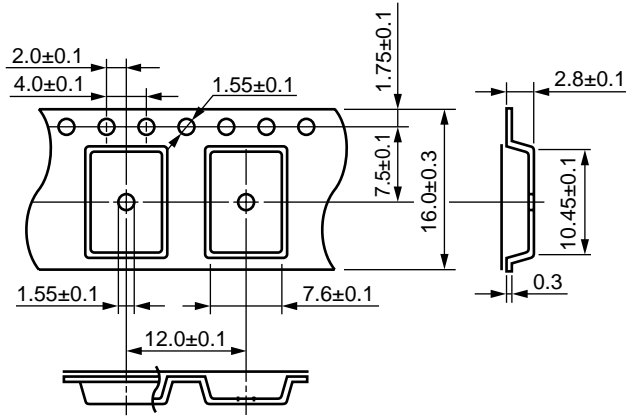

Tape Direction

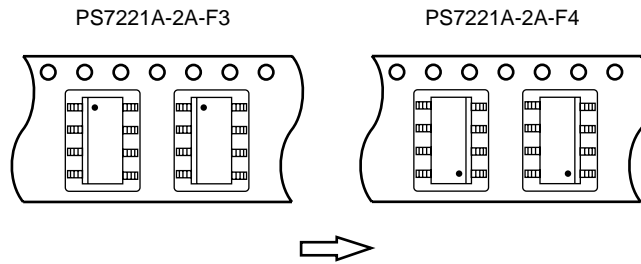

Outline and Dimensions (Reel)

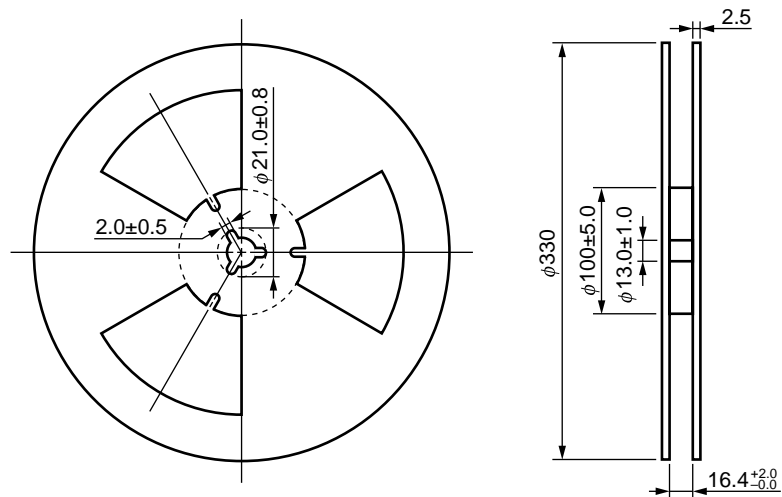

Packing: 1 500 pcs/reel



★ **RECOMMENDED SOLDERING CONDITIONS**

**(1) Infrared reflow soldering**

- Peak reflow temperature 235 °C or below (package surface temperature)
- Time of temperature higher than 210 °C 30 seconds or less
- Number of reflows Two
- Flux Rosin flux containing small amount of chlorine (The flux with a maximum chlorine content of 0.2 Wt % is recommended.)

Recommended Temperature Profile of Infrared Reflow

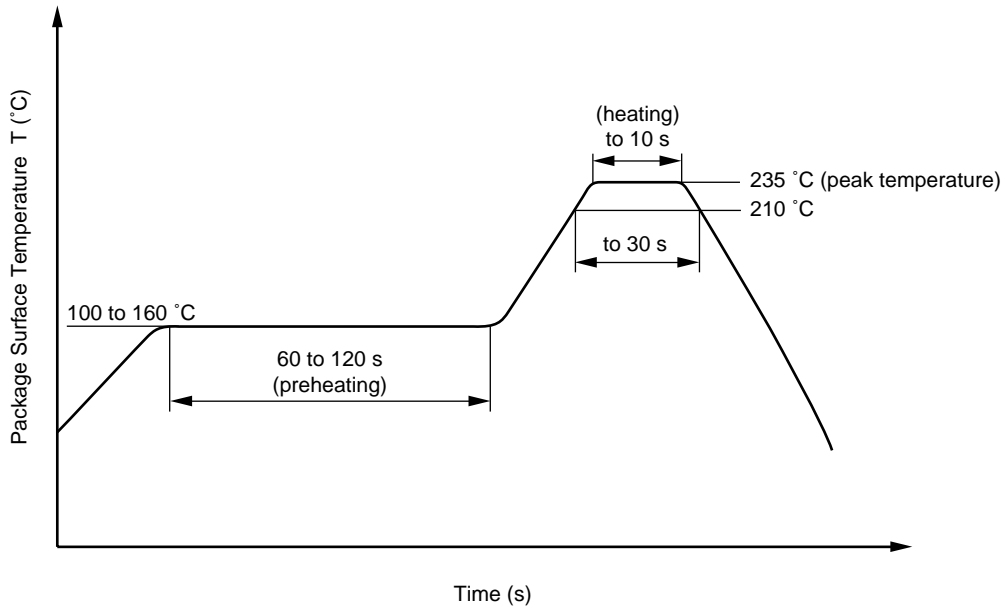

**(2) Dip soldering**

- Temperature 260 °C or below (molten solder temperature)
- Time 10 seconds or less
- Number of times One
- Flux Rosin flux containing small amount of chlorine (The flux with a maximum chlorine content of 0.2 Wt % is recommended.)

**(3) Cautions**

- Fluxes  
Avoid removing the residual flux with freon-based and chlorine-based cleaning solvent.
- Avoid shorting between portion of frame and leads.

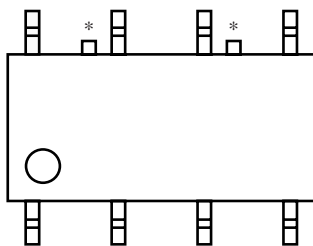

\* : Portion of frame

[MEMO]

[MEMO]

## CAUTION

**Within this device there exists GaAs (Gallium Arsenide) material which is a harmful substance if ingested. Please do not under any circumstances break the hermetic seal.**

- **The information in this document is current as of June, 2000. The information is subject to change without notice. For actual design-in, refer to the latest publications of NEC's data sheets or data books, etc., for the most up-to-date specifications of NEC semiconductor products. Not all products and/or types are available in every country. Please check with an NEC sales representative for availability and additional information.**
  - No part of this document may be copied or reproduced in any form or by any means without prior written consent of NEC. NEC assumes no responsibility for any errors that may appear in this document.
  - NEC does not assume any liability for infringement of patents, copyrights or other intellectual property rights of third parties by or arising from the use of NEC semiconductor products listed in this document or any other liability arising from the use of such products. No license, express, implied or otherwise, is granted under any patents, copyrights or other intellectual property rights of NEC or others.
  - Descriptions of circuits, software and other related information in this document are provided for illustrative purposes in semiconductor product operation and application examples. The incorporation of these circuits, software and information in the design of customer's equipment shall be done under the full responsibility of customer. NEC assumes no responsibility for any losses incurred by customers or third parties arising from the use of these circuits, software and information.
  - While NEC endeavours to enhance the quality, reliability and safety of NEC semiconductor products, customers agree and acknowledge that the possibility of defects thereof cannot be eliminated entirely. To minimize risks of damage to property or injury (including death) to persons arising from defects in NEC semiconductor products, customers must incorporate sufficient safety measures in their design, such as redundancy, fire-containment, and anti-failure features.
  - NEC semiconductor products are classified into the following three quality grades:  
"Standard", "Special" and "Specific". The "Specific" quality grade applies only to semiconductor products developed based on a customer-designated "quality assurance program" for a specific application. The recommended applications of a semiconductor product depend on its quality grade, as indicated below. Customers must check the quality grade of each semiconductor product before using it in a particular application.  
"Standard": Computers, office equipment, communications equipment, test and measurement equipment, audio and visual equipment, home electronic appliances, machine tools, personal electronic equipment and industrial robots  
"Special": Transportation equipment (automobiles, trains, ships, etc.), traffic control systems, anti-disaster systems, anti-crime systems, safety equipment and medical equipment (not specifically designed for life support)  
"Specific": Aircraft, aerospace equipment, submersible repeaters, nuclear reactor control systems, life support systems and medical equipment for life support, etc.
- The quality grade of NEC semiconductor products is "Standard" unless otherwise expressly specified in NEC's data sheets or data books, etc. If customers wish to use NEC semiconductor products in applications not intended by NEC, they must contact an NEC sales representative in advance to determine NEC's willingness to support a given application.
- (Note)
- (1) "NEC" as used in this statement means NEC Corporation and also includes its majority-owned subsidiaries.  
(2) "NEC semiconductor products" means any semiconductor product developed or manufactured by or for NEC (as defined above).