



2.5 V to 5.5 V, 500 μ A, 2-Wire Interface Quad Voltage Output, 8-/10-/12-Bit DACs

AD5305/AD5315/AD5325*

FEATURES

AD5305

Four Buffered 8-Bit DACs in 10-Lead microSOIC

AD5315

Four Buffered 10-Bit DACs in 10-Lead microSOIC

AD5325

Four Buffered 12-Bit DACs in 10-Lead microSOIC

Low Power Operation: 500 μ A @ 3 V, 600 μ A @ 5 V

2-Wire (I²C[®]-Compatible) Serial Interface

2.5 V to 5.5 V Power Supply

Guaranteed Monotonic By Design Over All Codes

Power-Down to 80 nA @ 3 V, 200 nA @ 5 V

Double-Buffered Input Logic

Output Range: 0–V_{REF}

Power-On-Reset to Zero Volts

Simultaneous Update of Outputs ($\overline{\text{LDAC}}$ Function)

Software Clear Facility

Data Readback Facility

On-Chip Rail-to-Rail Output Buffer Amplifiers

Temperature Range –40°C to +105°C

APPLICATIONS

Portable Battery-Powered Instruments

Digital Gain and Offset Adjustment

Programmable Voltage and Current Sources

Programmable Attenuators

Industrial Process Control

GENERAL DESCRIPTION

The AD5305/AD5315/AD5325 are quad 8-, 10- and 12-bit buffered voltage output DACs in a 10-lead microSOIC package that operate from a single 2.5 V to 5.5 V supply consuming 500 μ A at 3 V. Their on-chip output amplifiers allow rail-to-rail output swing with a slew rate of 0.7 V/ μ s. A 2-wire serial interface is used which operates at clock rates up to 400 kHz. This interface is SMBus-compatible at V_{DD} < 3.6 V. Multiple devices can be placed on the same bus.

The references for the four DACs are derived from one reference pin. The outputs of all DACs may be updated simultaneously using the software $\overline{\text{LDAC}}$ function. The parts incorporate a power-on-reset circuit that ensures that the DAC outputs power up to zero volts and remain there until a valid write takes place to the device. There is also a software clear function which resets all input and DAC registers to 0 V. The parts contain a power-down feature that reduces the current consumption of the devices to 200 nA @ 5 V (80 nA @ 3 V).

The low power consumption of these parts in normal operation makes them ideally suited to portable battery-operated equipment. The power consumption is 3 mW at 5 V, 1.5 mW at 3 V, reducing to 1 μ W in power-down mode.

FUNCTIONAL BLOCK DIAGRAM

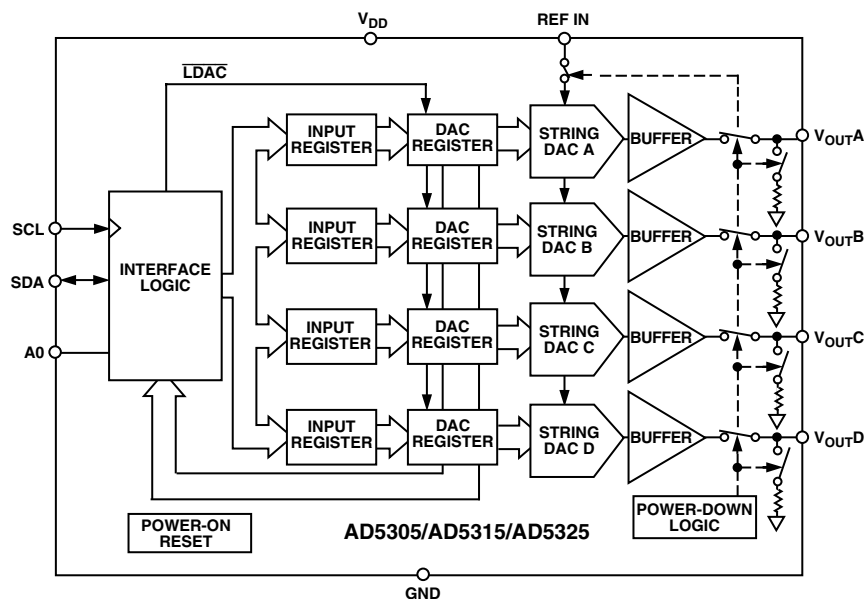

*Protected by U.S. Patent No. 5,969,657; other patents pending.
I²C is a registered trademark of Philips Corporation.

REV. B

Information furnished by Analog Devices is believed to be accurate and reliable. However, no responsibility is assumed by Analog Devices for its use, nor for any infringements of patents or other rights of third parties which may result from its use. No license is granted by implication or otherwise under any patent or patent rights of Analog Devices.

One Technology Way, P.O. Box 9106, Norwood, MA 02062-9106, U.S.A.
Tel: 781/329-4700 World Wide Web Site: <http://www.analog.com>
Fax: 781/326-8703 © Analog Devices, Inc., 2000

AD5305/AD5315/AD5325—SPECIFICATIONS

($V_{DD} = 2.5\text{ V to }5.5\text{ V}$; $V_{REF} = 2\text{ V}$; $R_L = 2\text{ k}\Omega$ to GND; $C_L = 200\text{ pF}$ to GND; All specifications T_{MIN} to T_{MAX} unless otherwise noted.)

Parameter ¹	B Version ²		Max	Unit	Conditions/Comments	
	Min	Typ				
DC PERFORMANCE^{3, 4}						
AD5305						
Resolution		8		Bits	Guaranteed Monotonic by Design Over All Codes	
Relative Accuracy		± 0.15	± 1	LSB		
Differential Nonlinearity		± 0.02	± 0.25	LSB		
AD5315						
Resolution		10		Bits	Guaranteed Monotonic by Design Over All Codes	
Relative Accuracy		± 0.5	± 4	LSB		
Differential Nonlinearity		± 0.05	± 0.5	LSB		
AD5325						
Resolution		12		Bits	Guaranteed Monotonic by Design Over All Codes	
Relative Accuracy		± 2	± 16	LSB		
Differential Nonlinearity		± 0.2	± 1	LSB		
Offset Error		± 0.4	± 3	% of FSR	Lower Deadband Exists Only If Offset Error Is Negative	
Gain Error		± 0.15	± 1	% of FSR		
Lower Deadband		20	60	mV		
Offset Error Drift ⁵		-12		ppm of FSR/ $^{\circ}\text{C}$		
Gain Error Drift ⁵		-5		ppm of FSR/ $^{\circ}\text{C}$		
Power Supply Rejection Ratio ⁵		-60		dB		
DC Crosstalk ⁵		200		μV		
$\Delta V_{DD} = \pm 10\%$						
$R_L = 2\text{ k}\Omega$ to GND or V_{DD}						
DAC REFERENCE INPUTS⁵						
V_{REF} Input Range	0.25		V_{DD}	V	Normal Operation Power-Down Mode Frequency = 10 kHz	
V_{REF} Input Impedance	37	45		k Ω		
Reference Feedthrough		>10		M Ω		
		-90		dB		
OUTPUT CHARACTERISTICS⁵						
Minimum Output Voltage ⁶		0.001		V	This is a measure of the minimum and maximum drive capability of the output amplifier.	
Maximum Output Voltage ⁶		$V_{DD} - 0.001$		V		
DC Output Impedance		0.5		Ω	$V_{DD} = 5\text{ V}$ $V_{DD} = 3\text{ V}$ Coming Out of Power-Down Mode. $V_{DD} = 5\text{ V}$ Coming Out of Power-Down Mode. $V_{DD} = 3\text{ V}$	
Short Circuit Current		25		mA		
		16		mA		
Power-Up Time		2.5		μs		
		5		μs		
LOGIC INPUTS (A0)⁵						
Input Current			± 1	μA	$V_{DD} = 5\text{ V} \pm 10\%$ $V_{DD} = 3\text{ V} \pm 10\%$ $V_{DD} = 2.5\text{ V}$ $V_{DD} = 5\text{ V} \pm 10\%$ $V_{DD} = 3\text{ V} \pm 10\%$ $V_{DD} = 2.5\text{ V}$	
V_{IL} Input Low Voltage			0.8	V		
			0.6	V		
			0.5	V		
V_{IH} Input High Voltage	2.4			V		
	2.1			V		
	2.0			V		
Pin Capacitance		3		pF		
LOGIC INPUTS (SCL, SDA)⁵						
V_{IH} Input High Voltage	$0.7 V_{DD}$		$V_{DD} + 0.3$	V	SMBus-Compatible at $V_{DD} < 3.6\text{ V}$ SMBus-Compatible at $V_{DD} < 3.6\text{ V}$	
V_{IL} Input Low Voltage	-0.3		$0.3 V_{DD}$	V		
I_{IN} Input Leakage Current			± 1	μA	Input filtering suppresses noise spikes of less than 50 ns.	
V_{HYST} Input Hysteresis	$0.05 V_{DD}$			V		
C_{IN} Input Capacitance		8		pF		
Glitch Rejection			50	ns		
LOGIC OUTPUT (SDA)⁵						
V_{OL} Output Low Voltage			0.4	V	$I_{SINK} = 3\text{ mA}$ $I_{SINK} = 6\text{ mA}$	
			0.6	V		
Three-State Leakage Current			± 1	μA		
Three-State Output Capacitance		8		pF		
POWER REQUIREMENTS						
V_{DD}	2.5		5.5	V	$V_{IH} = V_{DD}$ and $V_{IL} = \text{GND}$	
I_{DD} (Normal Mode) ⁷						
$V_{DD} = 4.5\text{ V to }5.5\text{ V}$		600	900	μA		
$V_{DD} = 2.5\text{ V to }3.6\text{ V}$		500	700	μA		
I_{DD} (Power-Down Mode)					$V_{IH} = V_{DD}$ and $V_{IL} = \text{GND}$, $I_{DD} = 4\text{ }\mu\text{A}$ (Max) During "0" Readback on SDA $I_{DD} = 1.5\text{ }\mu\text{A}$ (Max) During "0" Readback on SDA	
$V_{DD} = 4.5\text{ V to }5.5\text{ V}$		0.2	1	μA		
$V_{DD} = 2.5\text{ V to }3.6\text{ V}$		0.08	1	μA		

NOTES

¹See Terminology.

²Temperature range: B Version: -40°C to +105°C; typical at 25°C.

³DC specifications tested with the outputs unloaded.

⁴Linearity is tested using a reduced code range: AD5305 (Code 8 to 248); AD5315 (Code 28 to 995); AD5325 (Code 115 to 3981).

⁵Guaranteed by design and characterization, not production tested.

⁶For the amplifier output to reach its minimum voltage, Offset Error must be negative; to reach its maximum voltage, $V_{REF} = V_{DD}$ and “Offset plus Gain” Error must be positive.

⁷ T_{DD} specification is valid for all DAC codes. Interface inactive. All DACs active and excluding load currents.

Specifications subject to change without notice.

AC CHARACTERISTICS¹ ($V_{DD} = 2.5\text{ V to }5.5\text{ V}$; $R_L = 2\text{ k}\Omega$ to GND; $C_L = 200\text{ pF}$ to GND; all specifications T_{MIN} to T_{MAX} unless otherwise noted.)

Parameter ²	B Version ³			Unit	Conditions/Comments
	Min	Typ	Max		
Output Voltage Settling Time					$V_{REF} = V_{DD} = 5\text{ V}$
AD5305		6	8	μs	1/4 Scale to 3/4 Scale Change (40 Hex to C0 Hex)
AD5315		7	9	μs	1/4 Scale to 3/4 Scale Change (100 Hex to 300 Hex)
AD5325		8	10	μs	1/4 Scale to 3/4 Scale Change (400 Hex to C00 Hex)
Slew Rate		0.7		V/ μs	
Major-Code Transition Glitch Energy		12		nV-s	1 LSB Change Around Major Carry
Digital Feedthrough		1		nV-s	
Digital Crosstalk		1		nV-s	
DAC-to-DAC Crosstalk		3		nV-s	
Multiplying Bandwidth		200		kHz	$V_{REF} = 2\text{ V} \pm 0.1\text{ V p-p}$
Total Harmonic Distortion		-70		dB	$V_{REF} = 2.5\text{ V} \pm 0.1\text{ V p-p}$. Frequency = 10 kHz

NOTES

¹Guaranteed by design and characterization, not production tested.

²See Terminology.

³Temperature range: B Version: -40°C to +105°C; typical at 25°C.

Specifications subject to change without notice.

TIMING CHARACTERISTICS^{1, 2} ($V_{DD} = 2.5\text{ V to }5.5\text{ V}$. All specifications T_{MIN} to T_{MAX} unless otherwise noted)

Parameter	Limit at T_{MIN} , T_{MAX} (B Version)	Unit	Conditions/Comments
F_{SCL}	400	kHz max	SCL Clock Frequency
t_1	2.5	μs min	SCL Cycle Time
t_2	0.6	μs min	t_{HIGH} , SCL High Time
t_3	1.3	μs min	t_{LOW} , SCL Low Time
t_4	0.6	μs min	$t_{HD,STA}$, Start/Repeated Start Condition Hold Time
t_5	100	ns min	$t_{SU,DAT}$, Data Setup Time
t_6^3	0.9	μs max	$t_{HD,DAT}$, Data Hold Time
	0	μs min	$t_{HD,DAT}$, Data Hold Time
t_7	0.6	μs min	$t_{SU,STA}$, Setup Time for Repeated Start
t_8	0.6	μs min	$t_{SU,STO}$, Stop Condition Setup Time
t_9	1.3	μs min	t_{BUF} , Bus Free Time Between a STOP and a START Condition
t_{10}	300	ns max	t_R , Rise Time of SCL and SDA when Receiving
	0	ns min	t_R , Rise Time of SCL and SDA when Receiving (CMOS-Compatible)
t_{11}	250	ns max	t_F , Fall Time of SCL when Transmitting
	0	ns min	t_F , Fall Time of SDA when Receiving (CMOS-Compatible)
	300	ns max	t_F , Fall Time of SCL and SDA when Receiving
	$20 + 0.1C_B^3$	ns min	t_F , Fall Time of SCL and SDA when Transmitting
C_B	400	pF max	Capacitive Load for Each Bus Line

NOTES

¹See Figure 1.

²Guaranteed by design and characterization, not production tested.

³ C_B is the total capacitance of one bus line in pF. t_R and t_F measured between $0.3 V_{DD}$ and $0.7 V_{DD}$.

Specifications subject to change without notice.

AD5305/AD5315/AD5325

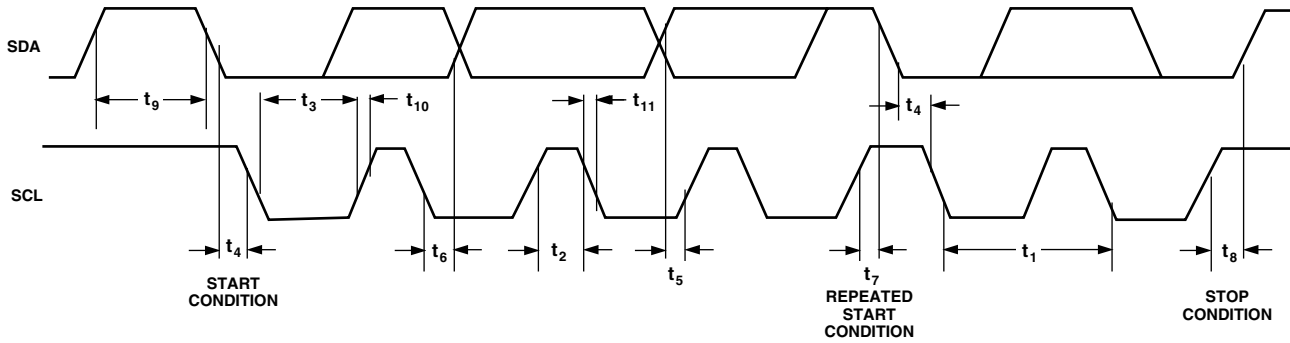

Figure 1. Two-Wire Serial Interface Timing Diagram

ABSOLUTE MAXIMUM RATINGS^{1,2}

($T_A = 25^\circ\text{C}$ unless otherwise noted)

V_{DD} to GND	-0.3 V to +7 V
SCL, SDA to GND	-0.3 V to $V_{DD} + 0.3$ V
A0 to GND	-0.3 V to $V_{DD} + 0.3$ V
Reference Input Voltage to GND	-0.3 V to $V_{DD} + 0.3$ V
V_{OUTA-D} to GND	-0.3 V to $V_{DD} + 0.3$ V
Operating Temperature Range		
Industrial (B Version)	-40°C to $+105^\circ\text{C}$
Storage Temperature Range	-65°C to $+150^\circ\text{C}$
Junction Temperature (T_J max)	150°C

microSOIC Package

Power Dissipation	$(T_J \text{ max} - T_A)/\theta_{JA}$
θ_{JA} Thermal Impedance	206°C/W
θ_{JC} Thermal Impedance	44°C/W
Reflow Soldering		
Peak Temperature	$220 \pm 5/0^\circ\text{C}$
Time at Peak Temperature	10 sec to 40 sec

NOTES

- ¹Stresses above those listed under Absolute Maximum Ratings may cause permanent damage to the device. This is a stress rating only; and functional operation of the device at these or any other conditions above those listed in the operational sections of this specification is not implied. Exposure to absolute maximum rating conditions for extended periods may affect device reliability.
- ²Transient currents of up to 100 mA will not cause SCR latch-up.

CAUTION

ESD (electrostatic discharge) sensitive device. Electrostatic charges as high as 4000 V readily accumulate on the human body and test equipment and can discharge without detection. Although the AD5305/AD5315/AD5325 features proprietary ESD protection circuitry, permanent damage may occur on devices subjected to high-energy electrostatic discharges. Therefore, proper ESD precautions are recommended to avoid performance degradation or loss of functionality.



ORDERING GUIDE

Model	Temperature Range	Package Description	Package Option	Branding Information
AD5305BRM	-40°C to $+105^\circ\text{C}$	10-Lead microSOIC	RM-10	DEB
AD5315BRM	-40°C to $+105^\circ\text{C}$	10-Lead microSOIC	RM-10	DFB
AD5325BRM	-40°C to $+105^\circ\text{C}$	10-Lead microSOIC	RM-10	DGB

PIN CONFIGURATION

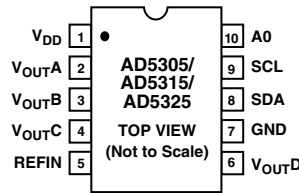

PIN FUNCTION DESCRIPTIONS

Pin No.	Mnemonic	Function
1	V _{DD}	Power Supply Input. These parts can be operated from 2.5 V to 5.5 V and the supply should be decoupled to GND.
2	V _{OUTA}	Buffered Analog Output Voltage from DAC A. The output amplifier has rail-to-rail operation.
3	V _{OUTB}	Buffered Analog Output Voltage from DAC B. The output amplifier has rail-to-rail operation.
4	V _{OUTC}	Buffered Analog Output Voltage from DAC C. The output amplifier has rail-to-rail operation.
5	REFIN	Reference Input Pin for All Four DACs. It has an input range from 0.25 V to V _{DD} .
6	V _{OUTD}	Buffered analog output voltage from DAC D. The output amplifier has rail-to-rail operation.
7	GND	Ground Reference Point for All Circuitry on the Part.
8	SDA	Serial Data Line. This is used in conjunction with the SCL line to clock data into or out of the 16-bit input shift register. It is a bidirectional open-drain data line that should be pulled to the supply with an external pull-up resistor.
9	SCL	Serial Clock Line. This is used in conjunction with the SDA line to clock data into or out of the 16-bit input shift register. Clock rates of up to 400 kbit/s can be accommodated in the 2-wire interface.
10	A0	Address Input. Sets the least significant bit of the 7-bit slave address.

TERMINOLOGY

RELATIVE ACCURACY

For the DAC, relative accuracy or integral nonlinearity (INL) is a measure of the maximum deviation, in LSBs, from a straight line passing through the endpoints of the DAC transfer function. Typical INL versus Code plots can be seen in Figures 4, 5, and 6.

DIFFERENTIAL NONLINEARITY

Differential Nonlinearity (DNL) is the difference between the measured change and the ideal 1 LSB change between any two adjacent codes. A specified differential nonlinearity of ± 1 LSB maximum ensures monotonicity. This DAC is guaranteed monotonic by design. Typical DNL versus Code plots can be seen in Figures 7, 8, and 9.

OFFSET ERROR

This is a measure of the offset error of the DAC and the output amplifier. It is expressed as a percentage of the full-scale range.

GAIN ERROR

This is a measure of the span error of the DAC. It is the deviation in slope of the actual DAC transfer characteristic from the ideal expressed as a percentage of the full-scale range.

OFFSET ERROR DRIFT

This is a measure of the change in offset error with changes in temperature. It is expressed in (ppm of full-scale range)/°C.

GAIN ERROR DRIFT

This is a measure of the change in gain error with changes in temperature. It is expressed in (ppm of full-scale range)/°C.

POWER-SUPPLY REJECTION RATIO (PSRR)

This indicates how the output of the DAC is affected by changes in the supply voltage. PSRR is the ratio of the change in V_{OUT} to a change in V_{DD} for full-scale output of the DAC. It is measured in dBs. V_{REF} is held at 2 V and V_{DD} is varied $\pm 10\%$.

DC CROSSTALK

This is the dc change in the output level of one DAC at mid-scale in response to a full-scale code change (all 0s to all 1s and vice versa) and output change of another DAC. It is expressed in μ V.

REFERENCE FEEDTHROUGH

This is the ratio of the amplitude of the signal at the DAC output to the reference input when the DAC output is not being updated. It is expressed in dBs.

AD5305/AD5315/AD5325

MAJOR-CODE TRANSITION GLITCH ENERGY

Major-code transition glitch energy is the energy of the impulse injected into the analog output when the code in the DAC register changes state. It is normally specified as the area of the glitch in nV-secs and is measured when the digital code is changed by 1 LSB at the major carry transition (011 . . . 11 to 100 . . . 00 or 100 . . . 00 to 011 . . . 11).

DIGITAL FEEDTHROUGH

Digital feedthrough is a measure of the impulse injected into the analog output of the DAC from the digital input pins of the device when the DAC output is not being updated. It is specified in nV-secs and is measured with a worst-case change on the digital input pins, e.g., from all 0s to all 1s or vice versa.

DIGITAL CROSSTALK

This is the glitch impulse transferred to the output of one DAC at midscale in response to a full-scale code change (all 0s to all 1s and vice versa) in the input register of another DAC. It is expressed in nV-secs.

DAC-TO-DAC CROSSTALK

This is the glitch impulse transferred to the output of one DAC due to a digital code change and subsequent output change of another DAC. This includes both digital and analog crosstalk. It is measured by loading one of the DACs with a full-scale code change (all 0s to all 1s and vice versa) with the $\overline{\text{LDAC}}$ bit set low and monitoring the output of another DAC. The energy of the glitch is expressed in nV-secs.

MULTIPLYING BANDWIDTH

The amplifiers within the DAC have a finite bandwidth. The multiplying bandwidth is a measure of this. A sine wave on the reference (with full-scale code loaded to the DAC) appears on the output. The multiplying bandwidth is the frequency at which the output amplitude falls to 3 dB below the input.

TOTAL HARMONIC DISTORTION

This is the difference between an ideal sine wave and its attenuated version using the DAC. The sine wave is used as the reference for the DAC and the THD is a measure of the harmonics present on the DAC output. It is measured in dBs.

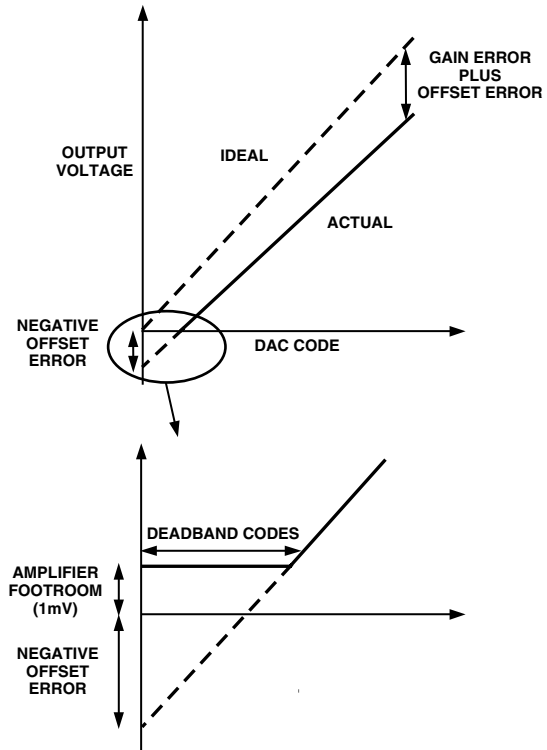

Figure 2. Transfer Function with Negative Offset

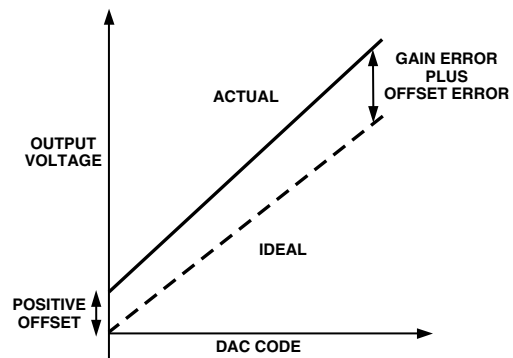

Figure 3. Transfer Function with Positive Offset

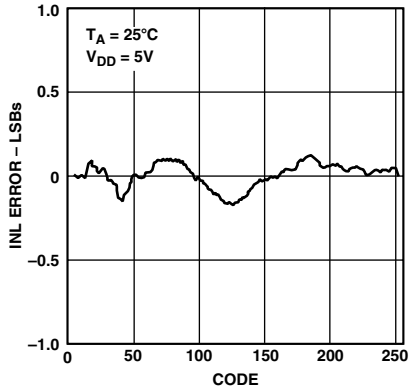

Figure 4. AD5305 Typical INL Plot

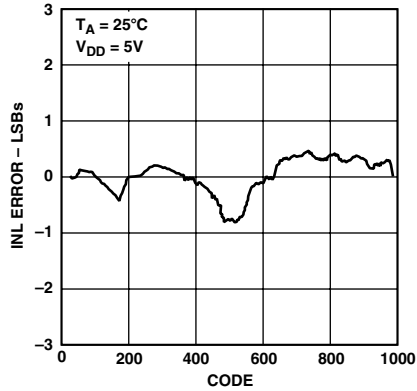

Figure 5. AD5315 Typical INL Plot

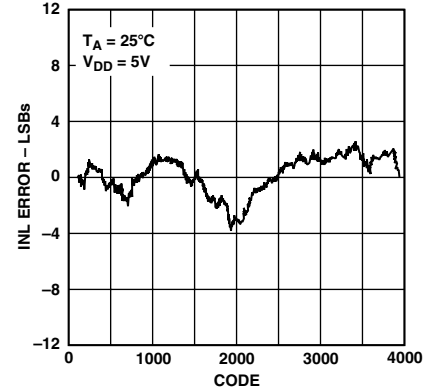

Figure 6. AD5325 Typical INL Plot

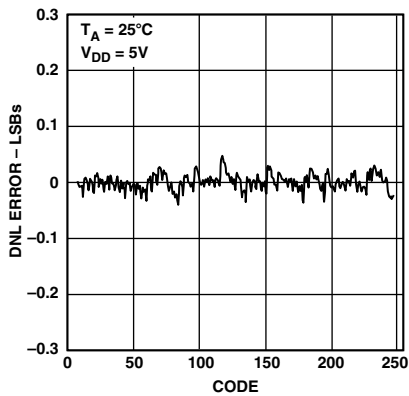

Figure 7. AD5305 Typical DNL Plot

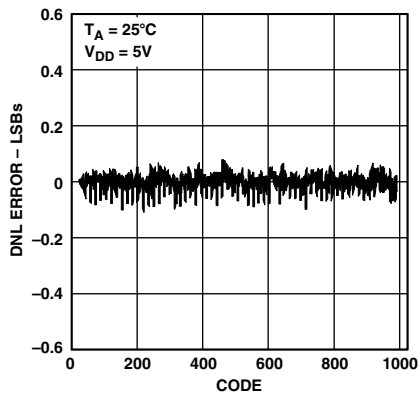

Figure 8. AD5315 Typical DNL Plot

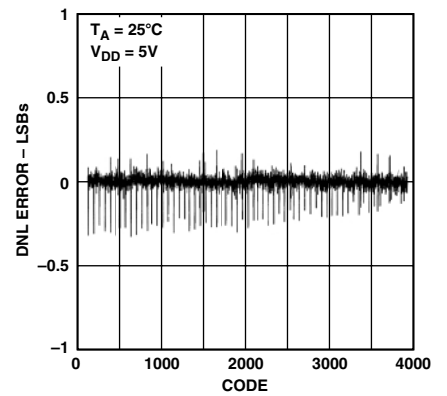

Figure 9. AD5325 Typical DNL Plot

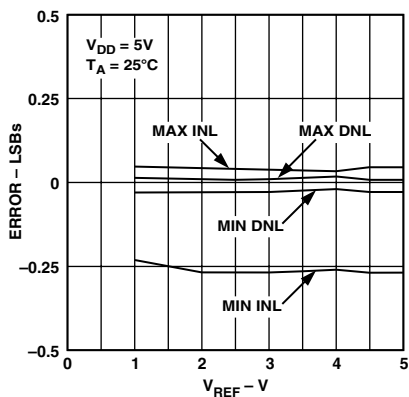

Figure 10. AD5305 INL and DNL Error vs. V_{REF}

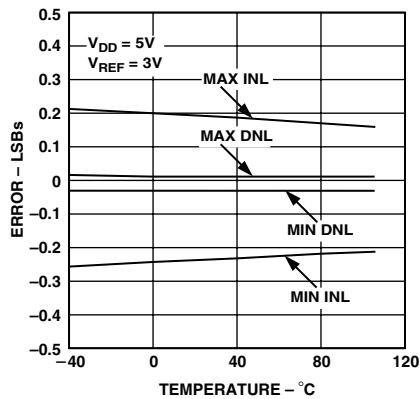

Figure 11. AD5305 INL Error and DNL Error vs. Temperature

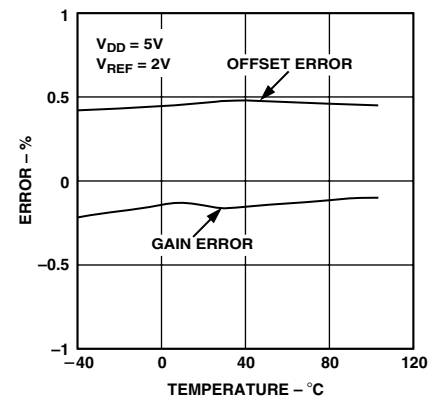

Figure 12. AD5305 Offset Error and Gain Error vs. Temperature

AD5305/AD5315/AD5325

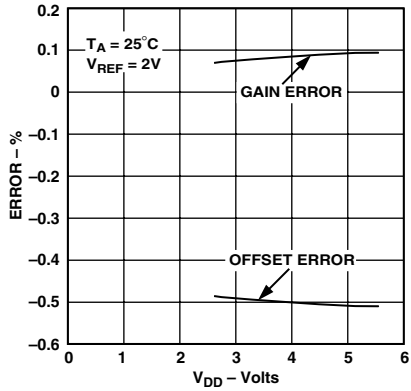

Figure 13. Offset Error and Gain Error vs. V_{DD}

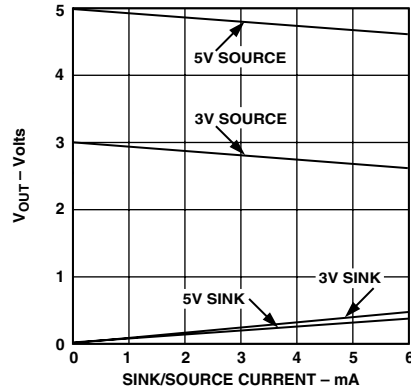

Figure 14. V_{OUT} Source and Sink Current Capability

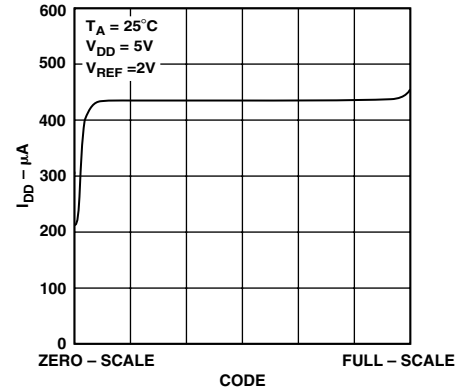

Figure 15. Supply Current vs. DAC Code

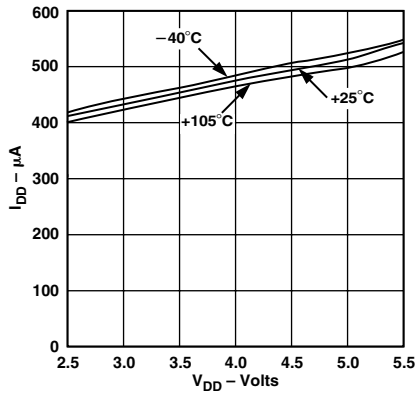

Figure 16. Supply Current vs. Supply Voltage

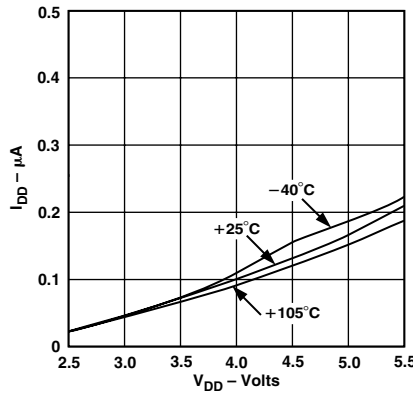

Figure 17. Power-Down Current vs. Supply Voltage

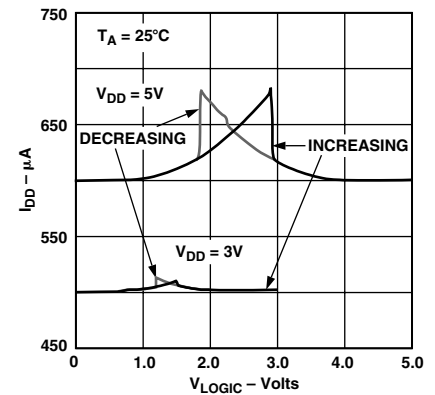

Figure 18. Supply Current vs. Logic Input Voltage for SDA and SCL Voltage Increasing and Decreasing

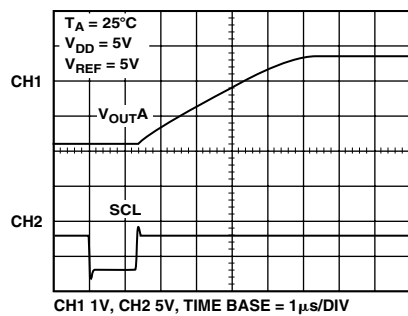

Figure 19. Half-Scale Settling (1/4 to 3/4 Scale Code Change)

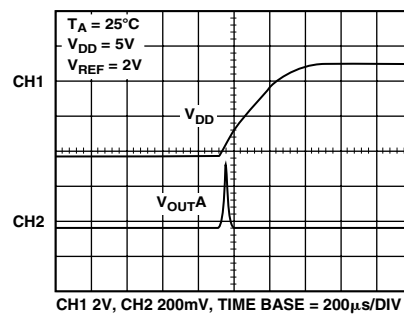

Figure 20. Power-On Reset to 0 V

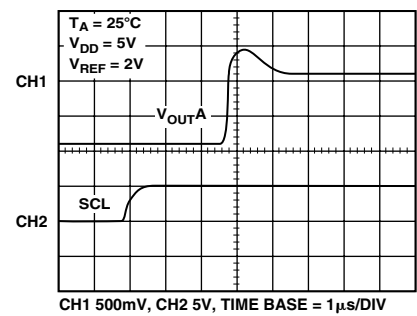

Figure 21. Exiting Power-Down to Midscale

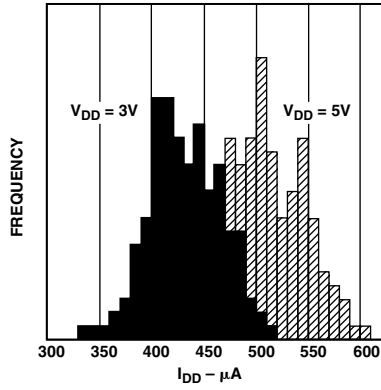

Figure 22. I_{DD} Histogram with $V_{DD} = 3\text{ V}$ and $V_{DD} = 5\text{ V}$

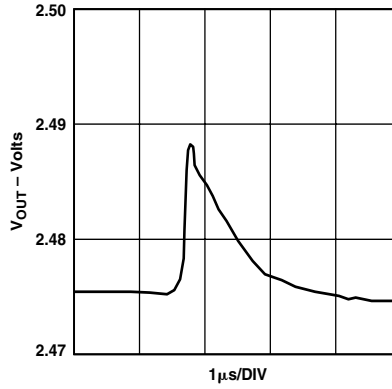

Figure 23. AD5325 Major-Code Transition Glitch Energy

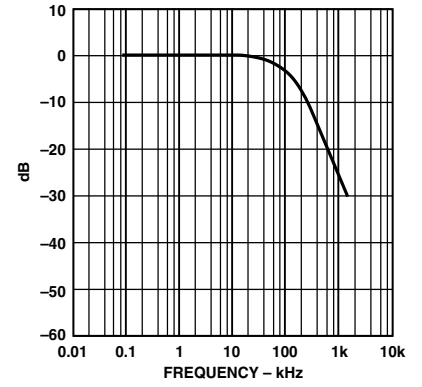

Figure 24. Multiplying Bandwidth (Small-Signal Frequency Response)

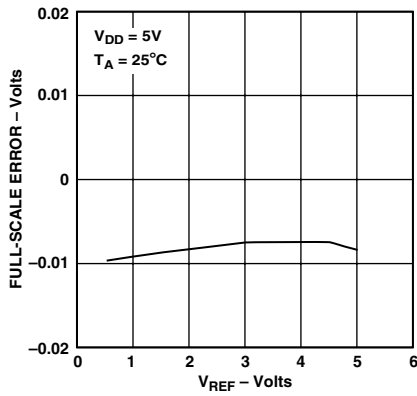

Figure 25. Full-Scale Error vs. V_{REF}

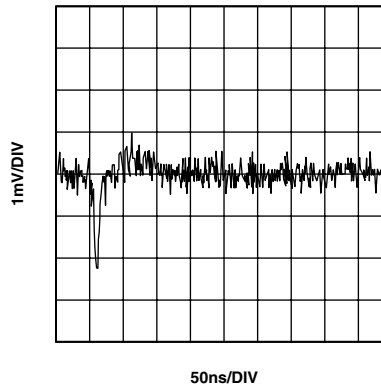

Figure 26. DAC-DAC Crosstalk

AD5305/AD5315/AD5325

FUNCTIONAL DESCRIPTION

The AD5305/AD5315/AD5325 are quad resistor-string DACs fabricated on a CMOS process with resolutions of 8, 10, and 12 bits respectively. Each contains four output buffer amplifiers and is written to via a 2-wire serial interface. They operate from single supplies of 2.5 V to 5.5 V, and the output buffer amplifiers provide rail-to-rail output swing with a slew rate of 0.7 V/μs. The four DACs share a single reference input pin. The devices have three programmable power-down modes, in which all DACs may be turned off completely with a high-impedance output, or the outputs may be pulled low by on-chip resistors.

Digital-to-Analog Section

The architecture of one DAC channel consists of a resistor-string DAC followed by an output buffer amplifier. The voltage at the REFIN pin provides the reference voltage for the DAC. Figure 27 shows a block diagram of the DAC architecture. Since the input coding to the DAC is straight binary, the ideal output voltage is given by:

$$V_{OUT} = \frac{V_{REF} \times D}{2^N}$$

where

D = decimal equivalent of the binary code, which is loaded to the DAC register;

- 0–255 for AD5305 (8 Bits)
- 0–1023 for AD5315 (10 Bits)
- 0–4095 for AD5325 (12 Bits)

N = DAC resolution

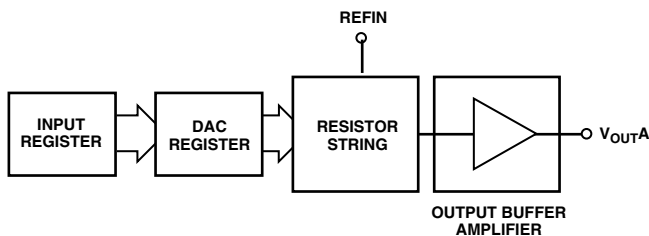

Figure 27. DAC Channel Architecture

Resistor String

The resistor string section is shown in Figure 28. It is simply a string of resistors, each of value R . The digital code loaded to the DAC register determines at what node on the string the voltage is tapped off to be fed into the output amplifier. The voltage is tapped off by closing one of the switches connecting the string to the amplifier. Because it is a string of resistors, it is guaranteed monotonic.

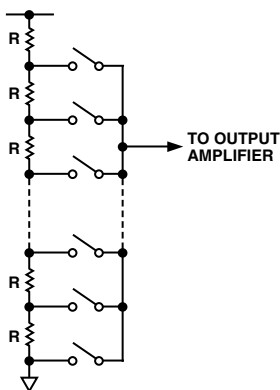

Figure 28. Resistor String

DAC Reference Inputs

There is a single reference input pin for the four DACs. The reference input is unbuffered. The user can have a reference voltage as low as 0.25 V and as high as V_{DD} since there is no restriction due to headroom and footroom of any reference amplifier.

It is recommended to use a buffered reference in the external circuit (e.g., REF192). The input impedance is typically 45 kΩ.

Output Amplifier

The output buffer amplifier is capable of generating rail-to-rail voltages on its output, which gives an output range of 0 V to V_{DD} when the reference is V_{DD} . It is capable of driving a load of 2 kΩ to GND or V_{DD} , in parallel with 500 pF to GND or V_{DD} . The source and sink capabilities of the output amplifier can be seen in the plot in Figure 14.

The slew rate is 0.7 V/μs with a half-scale settling time to ± 0.5 LSB (at 8 bits) of 6 μs.

POWER-ON RESET

The AD5305/AD5315/AD5325 are provided with a power-on reset function, so that they power up in a defined state. The power-on state is:

- Normal operation.
- Output voltage set to 0 V.

Both input and DAC registers are filled with zeros and remain so until a valid write sequence is made to the device. This is particularly useful in applications where it is important to know the state of the DAC outputs while the device is powering up.

SERIAL INTERFACE

The AD5305/AD5315/AD5325 are controlled via an I²C-compatible serial bus. The DACs are connected to this bus as slave devices (i.e., no clock is generated by the AD5305/AD5315/AD5325 DACs). This interface is SMBus-compatible at $V_{DD} < 3.6$ V.

The AD5305/AD5315/AD5325 have a 7-bit slave address. The 6 MSBs are 000110 and the LSB is determined by the state of the A0 pin. The facility to make hardwired changes to A0 allows the user to use up to two of these devices on one bus.

The 2-wire serial bus protocol operates as follows:

1. The master initiates data transfer by establishing a START condition, which is when a high-to-low transition on the SDA line occurs while SCL is high. The following byte is the address byte which consists of the 7-bit slave address followed by a R/\bar{W} bit (this bit determines whether data will be read from or written to the slave device).

The slave whose address corresponds to the transmitted address responds by pulling SDA low during the ninth clock pulse (this is termed the acknowledge bit). At this stage, all other devices on the bus remain idle while the selected device waits for data to be written to or read from its shift register.

2. Data is transmitted over the serial bus in sequences of nine clock pulses (8-data bits followed by an acknowledge bit). The transitions on the SDA line must occur during the low period of SCL and remain stable during the high period of SCL.

3. When all data bits have been read or written, a STOP condition is established. In write mode, the master will pull the SDA line high during the tenth clock pulse to establish a STOP condition. In read mode, the master will issue a No Acknowledge for the ninth clock pulse (i.e., the SDA line remains high). The master will then bring the SDA line low before the tenth clock pulse and then high during the tenth clock pulse to establish a STOP condition.

Read/Write Sequence

In the case of the AD5305/AD5315/AD5325, all write access sequences and most read sequences begin with the device address (with $R/\overline{W} = 0$) followed by the pointer byte. This pointer byte specifies the data format and determines which DAC is being accessed in the subsequent read/write operation. (See Figure 29.) In a write operation the data follows immediately. In a read operation the address is resent with $R/\overline{W} = 1$ and then the data is read back. However, it is also possible to perform a read operation by sending only the address with $R/\overline{W} = 1$. The previously loaded pointer settings are then used for the readback operation. See overleaf for a graphical explanation of the interface.

MSB								LSB
X	X	RIGHT/LEFT	SINGLE/DOUBLE	DACD	DACC	DACB	DACA	

Figure 29. Pointer Byte

Pointer Byte Bits

The following is an explanation of the individual bits that make up the Pointer Byte.

X: Don't Care Bits

RIGHT/LEFT:

- 0: Data written to the device and read from the device is Left-Justified (in Double Byte mode)
- 1: Data written to the device and read from the device is Right-Justified (in Double Byte mode)

SINGLE/DOUBLE:

- 0: Data Write and Readback are done as 2-byte write/read sequences
- 1: Data Write and Readback are done as 1-byte (most significant 8 bits only) write/read sequences

DACD 1: The following data bytes are for DAC D

DACC 1: The following data bytes are for DAC C

DACB 1: The following data bytes are for DAC B

DACA 1: The following data bytes are for DAC A

Input Shift Register

The input shift register is 16 bits wide. Data is loaded into the device as a 16-bit word under the control of a serial clock input, SCL. The timing diagram for this operation is shown in Figure 1. The 16-bit word consists of four control bits followed by 8, 10, or 12 bits of DAC data, depending on the device type. The first two bits loaded are \overline{PD} bits that control the mode of operation of the device. See Power-Down Modes section for a complete description. Bit 13 is \overline{CLR} , Bit 12 is \overline{LDAC} and the remaining bits are left- or right-justified DAC data bits, starting with the MSB. See Figure 30 overleaf.

CLR: 0: All DAC registers and input registers are filled with zeros on completion of the write sequence.

1: Normal operation.

LDAC: 0: All four DAC registers and hence all DAC outputs simultaneously updated on completion of the write sequence.

1: Addressed input register only is updated. There is no change in the contents of the DAC registers.

Default Readback Condition

All pointer byte bits power-up to 0. Therefore, if the user initiates a readback without writing to the pointer byte first, no single DAC channel has been specified. In this case, the default readback bits are all 0, except for the \overline{CLR} bit which is a 1.

Multiple-DAC Write Sequence

Because there are individual bits in the Pointer Byte for each DAC, it is possible to write the same data and control bits to 2, 3, or 4 DACs simultaneously by setting the relevant bits to 1.

Multiple-DAC Readback Sequence

If the user attempts to readback data from more than 1 DAC at a time, the part will read back the default, power-on-reset conditions for a double-byte readback, i.e., all 0s except for \overline{CLR} which is 1. For a single-byte readback, the part will read back all 0s.

AD5305/AD5315/AD5325

LEFT-JUSTIFIED DATA BYTES (WRITE AND READBACK)

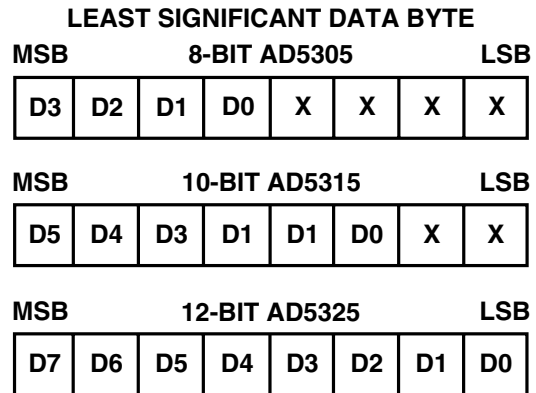
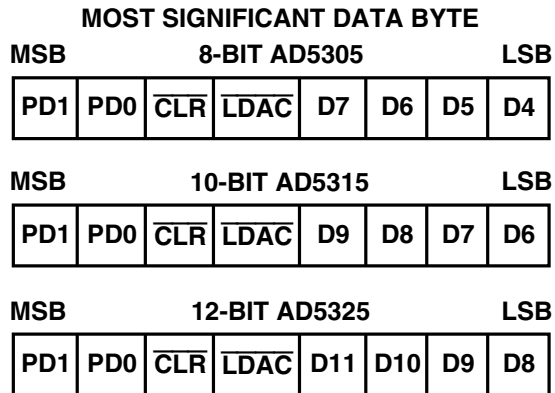

RIGHT-JUSTIFIED DATA BYTES (WRITE AND READBACK)

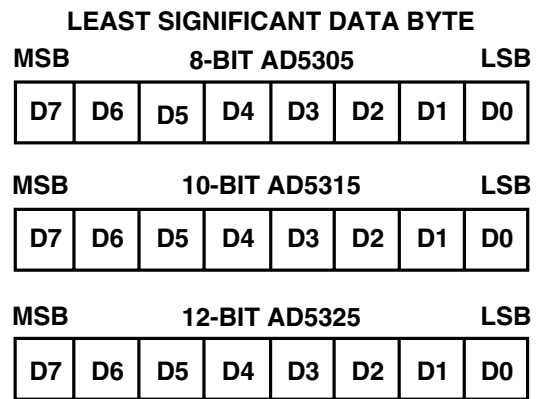
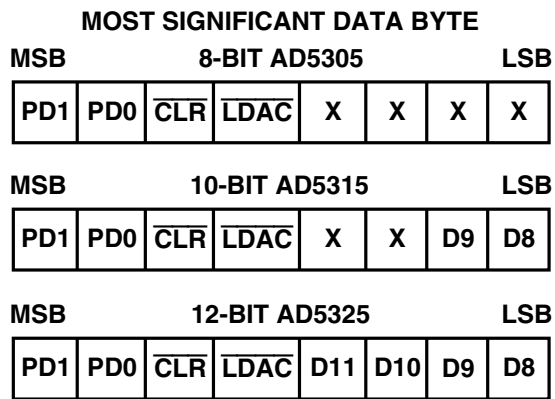

SINGLE BYTE ONLY (WRITE AND READBACK)

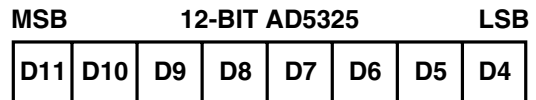
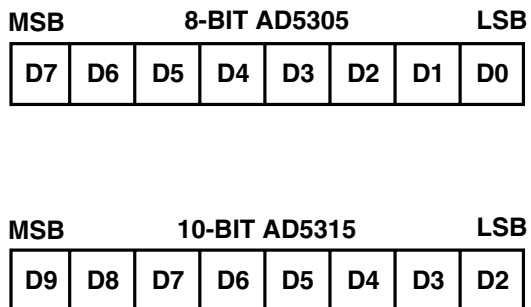

Figure 30. Double- and Single-Byte Data Formats

WRITE OPERATION

When writing to the AD5305/AD5315/AD5325 DACs, the user must begin with an address byte ($R/\overline{W} = 0$) after which the DAC will Acknowledge that it is prepared to receive data by pulling SDA low. This address byte is followed by the pointer byte

which is also acknowledged by the DAC. Depending on the value of SINGLE/DOUBLE, one or two bytes of data are then written to the DAC as shown in Figure 31 below. A STOP condition follows.

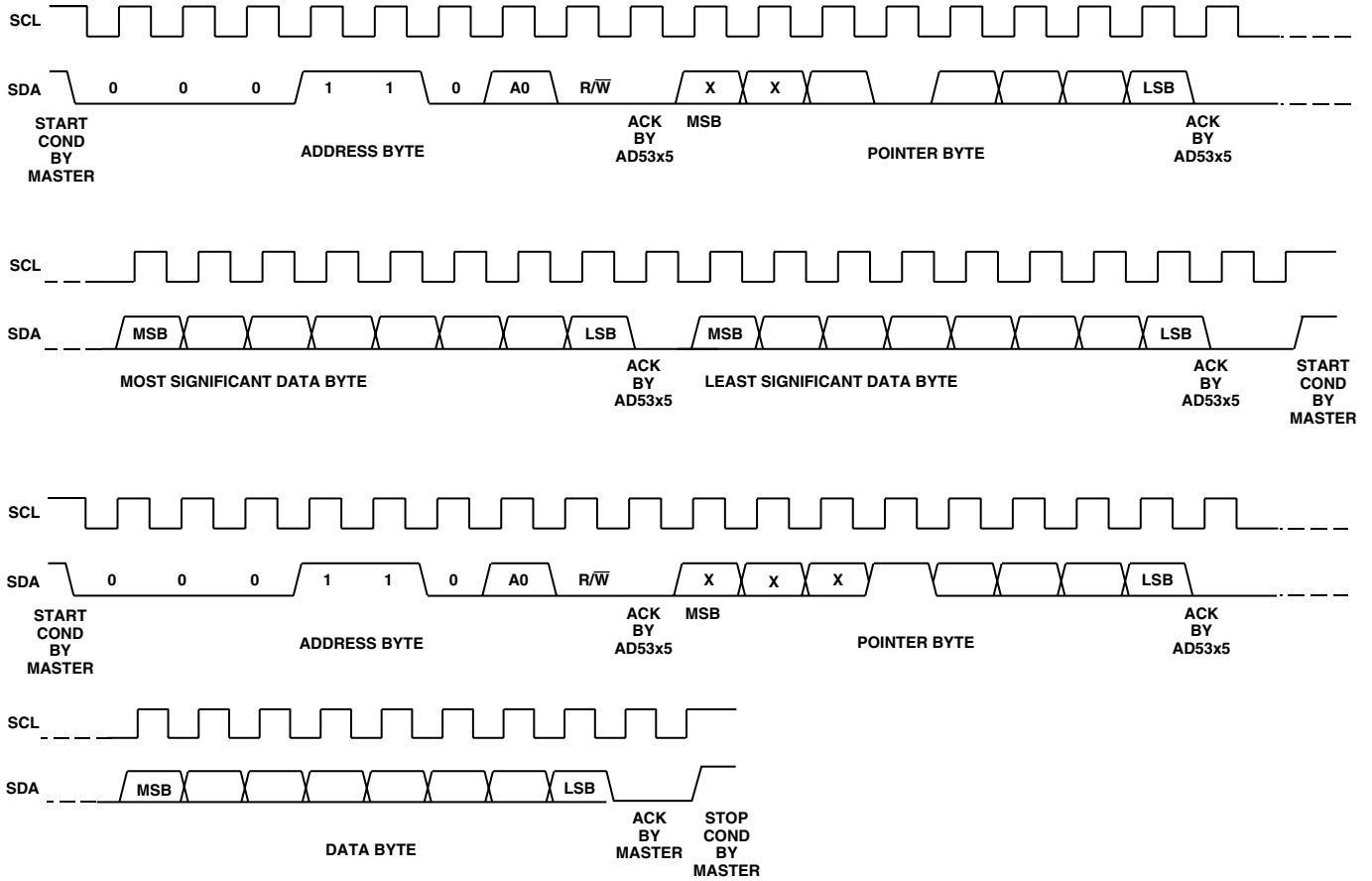

Figure 31. Double- and Single-Byte Write Sequences

AD5305/AD5315/AD5325

READ OPERATION

When reading data back from the AD5305/AD5315/AD5325 DACs, the user begins with an address byte ($R/\overline{W} = 0$) after which the DAC will Acknowledge that it is prepared to receive data by pulling SDA low. This address byte is usually followed by the pointer byte which is also acknowledged by the DAC. Following this, there is a repeated start condition by the master and the address is resent with $R/\overline{W} = 1$. This is acknowledged by the DAC indicating that it is prepared to transmit data. Depending

on the value of $\overline{SINGLE/DOUBLE}$, one or two bytes of data are then read from the DAC as shown in Figure 32 below.

However, if the master sends an ACK and continues clocking SCL (no STOP is sent), the DAC will retransmit the same one or two bytes of data on SDA. This allows continuous readback of data from the selected DAC register.

Alternatively the user may send a START followed by the address with $R/\overline{W} = 1$. In this case the previously loaded pointer settings are used and readback of data can commence immediately.

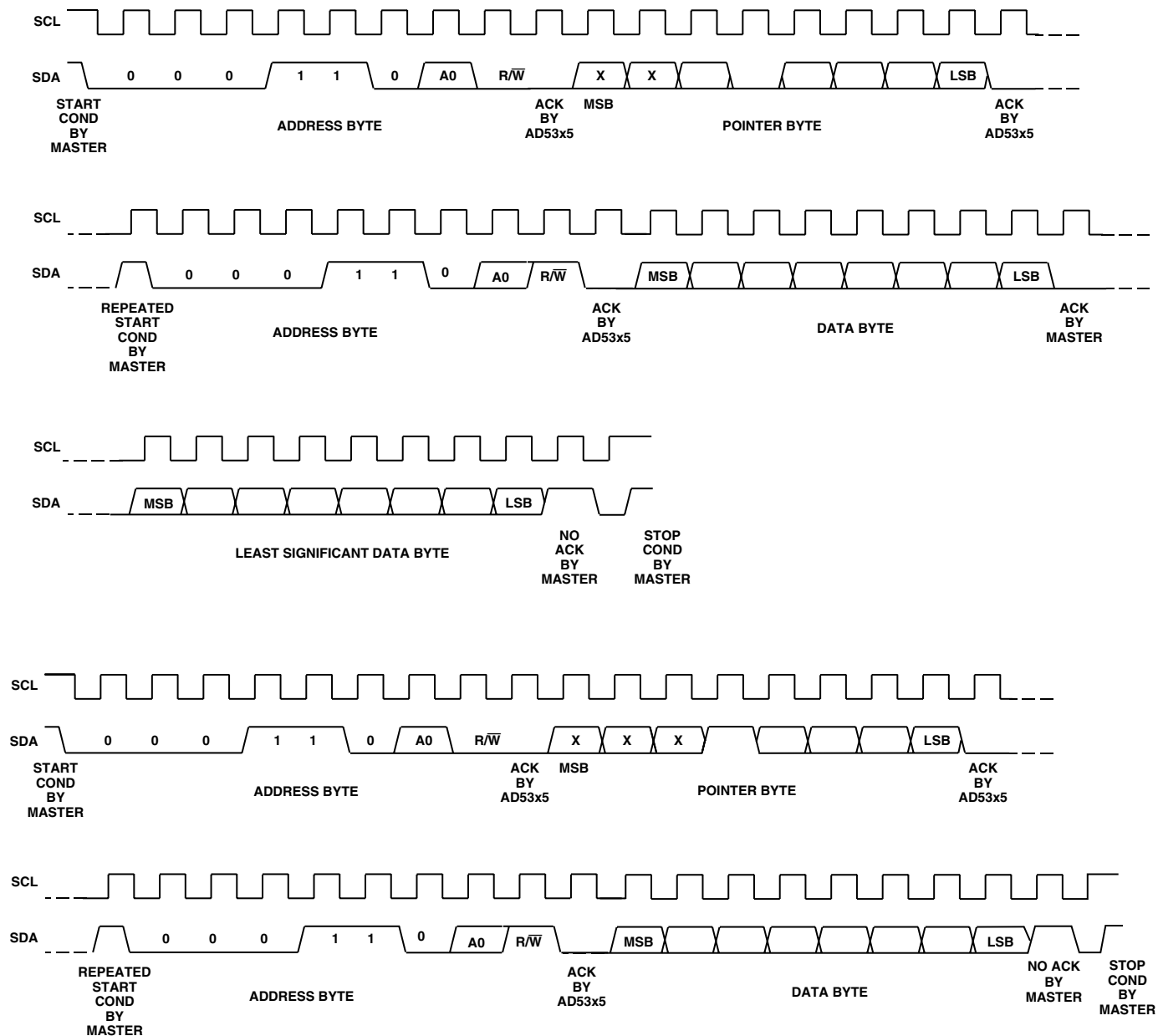

Figure 32. Double- and Single-Byte Read Sequences

DOUBLE-BUFFERED INTERFACE

The AD5305/AD5315/AD5325 DACs all have double-buffered interfaces consisting of two banks of registers—input registers and DAC registers. The input register is directly connected to the input shift register and the digital code is transferred to the relevant input register on completion of a valid write sequence. The DAC register contains the digital code used by the resistor string.

Access to the DAC register is controlled by the $\overline{\text{LDAC}}$ bit. When the $\overline{\text{LDAC}}$ bit is set high, the DAC register is latched and hence the input register may change state without affecting the contents of the DAC register. However, when the $\overline{\text{LDAC}}$ bit is set low, the DAC register becomes transparent and the contents of the input register are transferred to it.

This is useful if the user requires simultaneous updating of all DAC outputs. The user may write to three of the input registers individually and then, by setting the $\overline{\text{LDAC}}$ bit low when writing to the remaining DAC input register, all outputs will update simultaneously.

These parts contain an extra feature whereby the DAC register is not updated unless its input register has been updated since the last time that $\overline{\text{LDAC}}$ was brought low. Normally, when $\overline{\text{LDAC}}$ is brought low, the DAC registers are filled with the contents of the input registers. In the case of the AD5305/AD5315/AD5325, the part will only update the DAC register if the input register has been changed since the last time the DAC register was updated, thereby removing unnecessary digital crosstalk.

POWER-DOWN MODES

The AD5305/AD5315/AD5325 have very low power consumption, dissipating typically 1.5 mW with a 3 V supply and 3 mW with a 5 V supply. Power consumption can be further reduced when the DACs are not in use by putting them into one of three power-down modes, which are selected by Bits 15 and 14 (PD1 and PD0) of the data byte. Table I shows how the state of the bits corresponds to the mode of operation of the DAC.

Table I. PD1/PD0 Operating Modes

PD1	PD0	Operating Mode
0	0	Normal Operation
0	1	Power-Down (1 k Ω Load to GND)
1	0	Power-Down (100 k Ω Load to GND)
1	1	Power-Down (Three-State Output)

When both bits are set to 0, the DAC works normally with its normal power consumption of 600 μA at 5 V. However, for the three power-down modes, the supply current falls to 200 nA at 5 V (80 nA at 3 V). Not only does the supply current drop, but the output stage is also internally switched from the output of the amplifier to a resistor network of known values. This has an advantage in that the output impedance of the part is known while the part is in power-down mode and provides a defined input condition for whatever is connected to the output of the DAC amplifier. There are three different options. The output is connected internally to GND through a 1 k Ω resistor, a 100 k Ω resistor or it is left open-circuited (Three-State). Resistor tolerance = $\pm 20\%$. The output stage is illustrated in Figure 33.

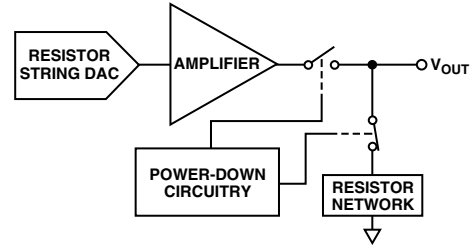

Figure 33. Output Stage During Power-Down

The bias generator, the output amplifiers, the resistor string, and all other associated linear circuitry are all shut down when the power-down mode is activated. However, the contents of the DAC registers are unchanged when in power-down. The time to exit power-down is typically 2.5 μs for $V_{\text{DD}} = 5 \text{ V}$ and 5 μs when $V_{\text{DD}} = 3 \text{ V}$. This is the time from the rising edge of the sixteenth SCL pulse to when the output voltage deviates from its power-down voltage. See Figure 21 for a plot.

APPLICATIONS

Typical Application Circuit

The AD5305/AD5315/AD5325 can be used with a wide range of reference voltages where the devices offer full, one-quadrant multiplying capability over a reference range of 0 V to V_{DD} . More typically, these devices are used with a fixed, precision reference voltage. Suitable references for 5 V operation are the AD780 and REF192 (2.5 V references). For 2.5 V operation, a suitable external reference would be the AD589, a 1.23 V band-gap reference. Figure 34 shows a typical setup for the AD5305/AD5315/AD5325 when using an external reference. Note that A0 can be high or low.

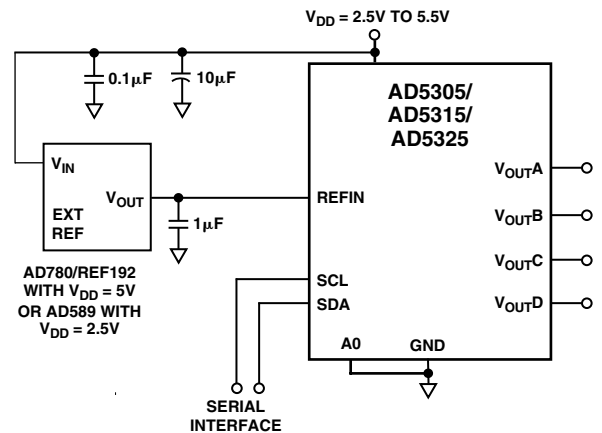

Figure 34. AD5305/AD5315/AD5325 Using External Reference

AD5305/AD5315/AD5325

If an output range of 0 V to V_{DD} is required, the simplest solution is to connect the reference input to V_{DD} . As this supply may not be very accurate and may be noisy, the AD5305/AD5315/AD5325 may be powered from the reference voltage; for example, using a 5 V reference such as the REF195. The REF195 will output a steady supply voltage for the AD5305/AD5315/AD5325. The typical current required from the REF195 is 600 μ A supply current and approximately 112 μ A into the reference input. This is with no load on the DAC outputs. When the DAC outputs are loaded, the REF195 also needs to supply the current to the loads. The total current required (with a 10 k Ω load on each output) is:

$$712 \mu A + 4(5 V/10 k\Omega) = 2.70 mA$$

The load regulation of the REF195 is typically 2 ppm/mA, which results in an error of 5.4 ppm (27 μ V) for the 2.7 mA current drawn from it. This corresponds to a 0.0014 LSB error at 8 bits and 0.022 LSB error at 12 bits.

Bipolar Operation Using the AD5305/AD5315/AD5325

The AD5305/AD5315/AD5325 have been designed for single-supply operation, but a bipolar output range is also possible using the circuit in Figure 35. This circuit will give an output voltage range of ± 5 V. Rail-to-rail operation at the amplifier output is achievable using an AD820 or an OP295 as the output amplifier.

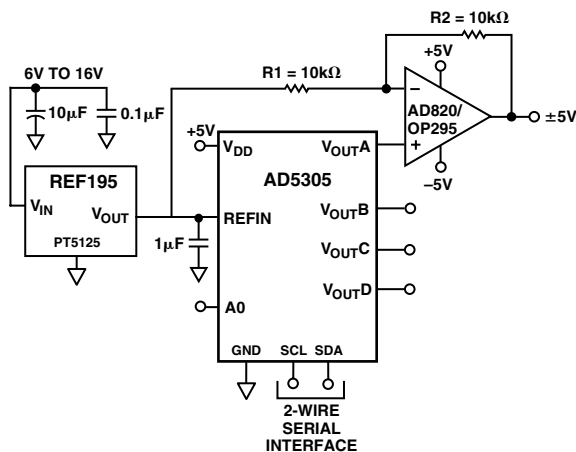

Figure 35. Bipolar Operation with the AD5305

The output voltage for any input code can be calculated as follows:

$$V_{OUT} = [(REFIN \times (D/2^N) \times (R1+R2)/R1) - REFIN \times (R2/R1)]$$

where:

D is the decimal equivalent of the code loaded to the DAC.

N is the DAC resolution.

$REFIN$ is the reference voltage input.

with:

$$REFIN = 5 V, R1 = R2 = 10 k\Omega:$$

$$V_{OUT} = (10 \times D/2^N) - 5 V$$

Multiple Devices on One Bus

Figure 36 below shows two AD5305 devices on the same serial bus. Each has a different slave address since the state of the A0 pin is different. This allows each of eight DACs to be written to or read from independently.

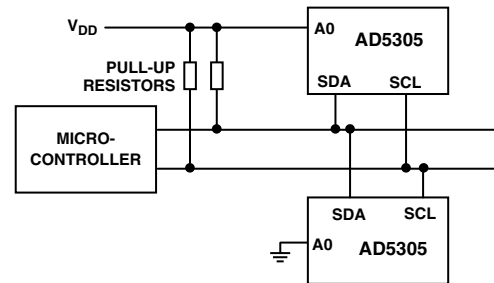

Figure 36. Multiple AD5305 Devices on One Bus

AD5305/AD5315/AD5325 as a Digitally Programmable Window Detector

A digitally programmable upper/lower limit detector using two of the DACs in the AD5305/AD5315/AD5325 is shown in Figure 37. The upper and lower limits for the test are loaded to DACs A and B which, in turn, set the limits on the CMP04. If the signal at the V_{IN} input is not within the programmed window, an LED will indicate the fail condition. Similarly, DACs C and D can be used for window detection on a second V_{IN} signal.

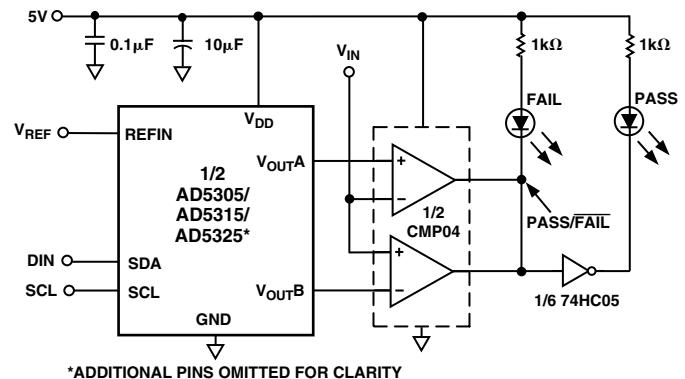

Figure 37. Window Detection

Coarse and Fine Adjustment Using the AD5305/AD5315/AD5325

Two of the DACs in the AD5305/AD5315/AD5325 can be paired together to form a coarse and fine adjustment function, as shown in Figure 38. DAC A is used to provide the coarse adjustment while DAC B provides the fine adjustment. Varying the ratio of $R1$ and $R2$ will change the relative effect of the coarse and fine adjustments. With the resistor values and external reference shown, the output amplifier has unity gain for the DAC A output, so the output range is 0 V to 2.5 V – 1 LSB. For DAC B the amplifier has a gain of 7.6×10^{-3} , giving DAC B a range equal to 19 mV. Similarly, DACs C and D can be paired together for coarse and fine adjustment.

The circuit is shown with a 2.5 V reference, but reference voltages up to V_{DD} may be used. The op amps indicated will allow a rail-to-rail output swing.

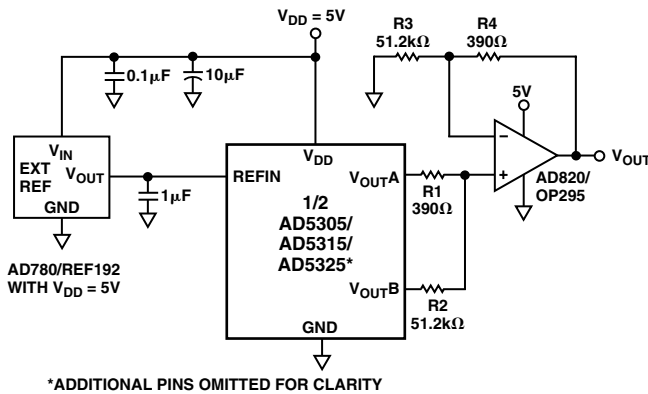

Figure 38. Coarse/Fine Adjustment

POWER SUPPLY DECOUPLING

In any circuit where accuracy is important, careful consideration of the power supply and ground return layout helps to ensure the rated performance. The printed circuit board on which the AD5305/AD5315/AD5325 is mounted should be designed so that the analog and digital sections are separated, and confined to certain areas of the board. If the AD5305/AD5315/AD5325 is in a system where multiple devices require an AGND-to-DGND connection, the connection should be made at one point only.

The star ground point should be established as close as possible to the device. The AD5305/AD5315/AD5325 should have ample supply bypassing of 10 μF in parallel with 0.1 μF on the supply located as close to the package as possible, ideally right up against the device. The 10 μF capacitors are the tantalum bead type. The 0.1 μF capacitor should have low Effective Series Resistance (ESR) and Effective Series Inductance (ESI), like the common ceramic types that provide a low impedance path to ground at high frequencies, to handle transient currents due to internal logic switching.

The power supply lines of the AD5305/AD5315/AD5325 should use as large a trace as possible to provide low impedance paths and reduce the effects of glitches on the power supply line. Fast switching signals such as clocks should be shielded with digital ground to avoid radiating noise to other parts of the board, and should never be run near the reference inputs. A ground line routed between the SDA and SCL lines will help reduce crosstalk between them (not required on a multilayer board as there will be a separate ground plane, but separating the lines will help).

Avoid crossover of digital and analog signals. Traces on opposite sides of the board should run at right angles to each other. This reduces the effects of feedthrough through the board. A microstrip technique is by far the best, but not always possible with a double-sided board. In this technique, the component side of the board is dedicated to ground plane while signal traces are placed on the solder side.

AD5305/AD5315/AD5325

Table II. Overview of All AD53xx Serial Devices

Part No.	Resolution	No. of DACs	DNL	Interface	Settling Time	Package	Pins
SINGLES							
AD5300	8	1	± 0.25	SPI	4 μ s	SOT-23, microSOIC	6, 8
AD5310	10	1	± 0.5	SPI	6 μ s	SOT-23, microSOIC	6, 8
AD5320	12	1	± 1.0	SPI	8 μ s	SOT-23, microSOIC	6, 8
AD5301	8	1	± 0.25	2-Wire	6 μ s	SOT-23, microSOIC	6, 8
AD5311	10	1	± 0.5	2-Wire	7 μ s	SOT-23, microSOIC	6, 8
AD5321	12	1	± 1.0	2-Wire	8 μ s	SOT-23, microSOIC	6, 8
DUALS							
AD5302	8	2	± 0.25	SPI	6 μ s	microSOIC	8
AD5312	10	2	± 0.5	SPI	7 μ s	microSOIC	8
AD5322	12	2	± 1.0	SPI	8 μ s	microSOIC	8
AD5303	8	2	± 0.25	SPI	6 μ s	TSSOP	16
AD5313	10	2	± 0.5	SPI	7 μ s	TSSOP	16
AD5323	12	2	± 1.0	SPI	8 μ s	TSSOP	16
QUADS							
AD5304	8	4	± 0.25	SPI	6 μ s	microSOIC	10
AD5314	10	4	± 0.5	SPI	7 μ s	microSOIC	10
AD5324	12	4	± 1.0	SPI	8 μ s	microSOIC	10
AD5305	8	4	± 0.25	2-Wire	6 μ s	microSOIC	10
AD5315	10	4	± 0.5	2-Wire	7 μ s	microSOIC	10
AD5325	12	4	± 1.0	2-Wire	8 μ s	microSOIC	10
AD5306	8	4	± 0.25	2-Wire	6 μ s	TSSOP	16
AD5316	10	4	± 0.5	2-Wire	7 μ s	TSSOP	16
AD5326	12	4	± 1.0	2-Wire	8 μ s	TSSOP	16
AD5307	8	4	± 0.25	SPI	6 μ s	TSSOP	16
AD5317	10	4	± 0.5	SPI	7 μ s	TSSOP	16
AD5327	12	4	± 1.0	SPI	8 μ s	TSSOP	16

Visit our web-page at http://www.analog.com/support/standard_linear/selection_guides/AD53xx.html

OUTLINE DIMENSIONS

Dimensions shown in inches and (mm).

**10-Lead microSOIC
(RM-10)**

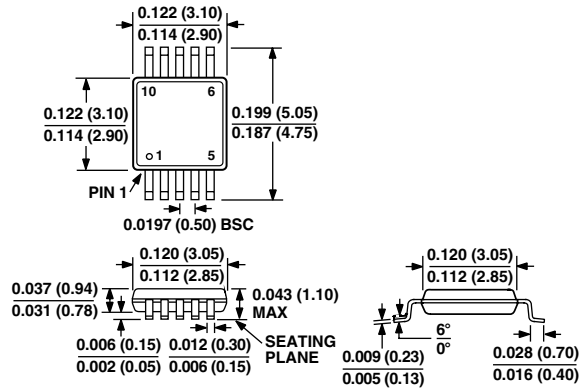

C3722a-2.5-6/00 (rev. B) 00930

PRINTED IN U.S.A.